

**National Highways & Infrastructure Development Corporation Ltd.**

(MINISTRY OF ROAD TRANSPORT & HIGHWAYS, GOVT.OF INDIA)

**Request for Proposal  
For**

Providing of incident Management Services (Route Patrol, Crane, Ambulance & JCB)  
for National Highways in the State of Tripura.

**September -2020**

National Highways & Infrastructure Development Corporation Ltd.  
(Ministry of Road, Transport & Highways)  
Regional Office, Agartala  
3<sup>rd</sup> Floor UD Bhawan, Near Ravindra Bhawan,  
Sakuntala Road, Agartala, Tripura-799001

Contact no:- 0381-2300127 , Email: [edp-agartala@nhidcl.com](mailto:edp-agartala@nhidcl.com)

## **CONTENTS**

### **VOLUME - I**

#### **TITLE**

SECTION I	NOTICE INVITING TENDER
SECTION II	INSTRUCTIONS TO BIDDERS & APPENDIX TO BID
SECTION III	QUALIFICATION INFORMATION
SECTION IV	FORM OF BANK GUARANTEE, AGREEMENT & LOA
SECTION V	CONDITIONS OF CONTRACT & CONTRACT DATA
SECTION VI	SCOPE OF WORK
SECTION VII	TECHNICAL SPECIFICATIONS

---

**(SECTION-I)**  
**NOTICE INVITING TENDER**

**National Highways and Infrastructure Corporation Ltd**  
**Notice Inviting BID/TENDER**  
**(National Competitive Bidding through e-Tendering mode only)**

File No NHIDCL/RO-Agt/IMS/2020-21/389

Date: 26<sup>th</sup> Sept 2020

National Highways and Infrastructure Corporation Ltd. (hereinafter called “the Employer”) invites sealed bids in single stage two cover system i.e. the Technical and Financial Bids on **Item Rate Basis** for the following work from the experienced firms/organizations excluding those firms who have been declared as non-performing by MoRTH/NHAI/NHIDCL or the firms those are blacklisted/debarred for specified period by MoRTH/NHAI/NHIDCL:-

Name of Project	NH-No.	Vehicles	Nos.	Stretch	Length approx (in km)	Estimated Cost excluding GST (Rs. in Lakhs)
Providing of incident Management Services (Route Patrol, Crane, Ambulance & JCB) for National Highways in the State of Tripura.	8	Route Patrol, Crane & Ambulance	1 each	Udaipur-Shantibazar- Sabroom	73	73.50
	8 & 208	Route Patrol, Crane	1 each	Khowai-Teliamura- Amarpur <b>And/or</b> Champaknagar-Teliamura- Ambassa	77	
	8	Ambulance	1	Kumarghat-Manu-Ambassa	53	
	-	JCB	2 (1 for each PMU)	to be deployed, as per direction of PMU Teliamura & Kumaraghat	-	

**Time of Completion:** 6 months (approx.) or upto 31.03.2021, whichever is earlier

**Cost of Bid Documents (Non-refundable):** Rs. 25,000/- at the time of the submission of the Bid proposal, in the form of RTGS-NEFT (Syndicate Bank A/c 7990101000226 (IFSC code- SYNB0007990)/Demand Draft only in favor of “Executive Director, NHIDCL, Agartala” payable at Agartala.

The preliminary requirements (detailed requirements are given in the Bid Document) of bidding firm / contractor for above packages are mentioned as under:-

Bid Security (In Rupees)	Average Turn-over during last 3 years (in Rupees)	Work of similar nature during last 7 years (in Rupees excluding GST)
(2% of estimated cost)	(30% of estimated cost)	Single work of Rs. (80% of estimated cost)  OR  Two works of Rs. (50% of estimated cost) each  OR  Three works of Rs. (40% of estimated cost) each

The Scope of Work is providing of incident management services viz. Route Patrol, Crane, JCB & Ambulance for NHs in the State of Tripura.

2. Date of Publishing is from 26.09.2020.

3. The complete BID document can be viewed / downloaded from web portal [www.eprocure.gov.in](http://www.eprocure.gov.in) from 26.09.2020 to 19.10.2020 (upto 1700 Hrs. IST).

4. Bidder must submit its Technical Bid and Financial bid at <https://eprocure.gov.in> on or before 19.10.2020 upto 1500 hours IST. Bids received online shall be opened on 20.10.2020 (at 1530 hours IST).

5. Bid documents can be seen at and downloaded from the website [www.nhidcl.com](http://www.nhidcl.com) and <https://eprocure.gov.in> Bid documents contain qualifying criteria for bidder, specification, bill of quantities, conditions and other details.

**Critical Date Sheet**

<b>S. No</b>	<b>Description</b>	<b>Period</b>
1.	Date of issue of NIT	26.09.2020 (1700 Hrs)
2.	Date of issue of Sale of Tender Documents	26.09.2020 (1700 Hours)
3.	Date of receipt of pre-bid queries	06.10.2020 (1430 Hours)
4.	Date of Pre-Bid meeting	06.10.2020 (1600 Hours)
5.	Date of uploading of reply to the pre-bid queries	07.10.2020 (1700 Hours)
6.	Bid submission start date	26.09.2020 (1500 Hrs)
	Bid submission End date (Online & physical copy)	19.10.2020 (1500 Hrs)
7.	Date of Opening of Technical Bid	20.10.2020 (1530Hrs)
8.	Date of Uploading of list of Technically Qualified Applicants	To be intimated later
9.	Date of Opening of Financial Bids of Qualified Applicants	To be intimated later
10.	Date of issue of letter of award (LOA)	To be intimated later
11.	Validity of Bid	120 days
12.	Date of Signing of Agreement	Within 15 days of award of LOA

For any clarification, the following office may be contacted:

**Executive Director (P)**

**Regional Office-Agartala**

**National Highways & Infrastructure Development Corporation Limited.**

**(Ministry of Road Transports & Highways, Government of Tripura)**

**Regional Office, 3<sup>rd</sup> floor, UD bhawan, Near Ravindra bhawan, Sakuntala, Agartala, Tripura**

**Email: [edp-agartala@nhidcl.com](mailto:edp-agartala@nhidcl.com)**

Conditional bids would be rejected. NHIDCL reserves the right to accept/reject any or all the bids without assigning any reasons thereof.

6. The intending bidder(s) must read the General Conditions of this contract carefully. He/ She should only submit his/her bid if eligible and in possession of all the documents required.

7. Information and instructions for bidders posted on website shall form part of the bid document.

8. The bid document consisting of scope of work and the set of terms and conditions of the contract to be complied with and other necessary documents can be seen and can be downloaded from website <https://eprocure.gov.in> and can also be viewed at [www.nhidcl.com](http://www.nhidcl.com).

9. The intending bidder(s) must have valid class-III Digital Signature Certificate to submit the bid.

10. Notwithstanding anything stated above, NHIDCL reserves the right to assess the capabilities and capacity of the bidder to perform the contract in the overall interest of NHIDCL.

11. The bidder(s) is/are required to quote strictly as per the terms and conditions, given in the tender documents and not to stipulate any deviations.

12. NHIDCL reserves the right to reject any or all tenders or cancel/withdraw the invitation for bids without assigning any reason whatsoever and in such case no bidder/intending bidder shall have any claim arising out of such action.

13. Integrity Pact duly signed by the bidder shall be submitted. Any bid without signed Integrity Pact shall be rejected.

## DISCLAIMER

The information contained in this Request for Proposal document (the “RFP”) or subsequently provided to Bidder(s), whether verbally or in documentary or any other form by or on behalf of the Authority or any of its employees or advisors, is provided to Bidder(s) on the terms and conditions set out in this RFP and such other terms and conditions subject to which such information is provided.

This RFP is not an Agreement and is neither an offer nor invitation by the Authority to the prospective Bidders or any other person. The purpose of this RFP is to provide interested parties with information that may be useful to them in making their financial offers (BIDs) pursuant to this RFP. This RFP includes statements, which reflect various assumptions and assessments arrived at by the Authority in relation to the Project. Such assumptions, assessments and statements do not purport to contain all the information that each Bidder may require. This RFP may not be appropriate for all persons, and it is not possible for the Authority, its employees or advisors to consider the investment objectives, financial situation and particular needs of each party who reads or uses this RFP. The assumptions, assessments, statements and information contained in the Bidding Documents, especially the Feasibility Report, may not be complete, accurate, adequate or correct. Each Bidder should, therefore, conduct its own investigations and analysis and should check the accuracy, adequacy, correctness, reliability and completeness of the assumptions, assessments, statements and information contained in this RFP and obtain independent advice from appropriate sources.

Information provided in this RFP to the Bidder(s) is on a wide range of matters, some of which may depend upon interpretation of law. The information given is not intended to be an exhaustive account of statutory requirements and should not be regarded as a complete or authoritative statement of law. The Authority accepts no responsibility for the accuracy or otherwise for any interpretation or opinion on law expressed herein.

The Authority, its employees and advisors make no representation or warranty and shall have no liability to any person, including any Applicant or Bidder under any law, statute, rules or regulations or tort, principles of restitution or unjust enrichment or otherwise for any loss, damages, cost or expense which may arise from or be incurred or suffered on account of anything contained in this RFP or otherwise, including the accuracy, adequacy, correctness, completeness or reliability of the RFP and any assessment, assumption, statement or information contained therein or deemed to form part of this RFP or arising in any way for participation in this BID Stage.

The Authority also accepts no liability of any nature whether resulting from negligence or otherwise howsoever caused arising from reliance of any Bidder upon the statements contained in this RFP. The Authority may in its absolute discretion, but without being under any obligation to do so, update, amend or supplement the information, assessment or assumptions contained in this RFP.

The issue of this RFP does not imply that the Authority is bound to select a Bidder or

to appoint the Selected Bidder JV or Contractor, as the case may be, for the Project and the Authority reserves the right to reject all or any of the Bidders or BIDs without assigning any reason whatsoever.

The Bidder shall bear all its costs associated with or relating to the preparation and submission of its BID including but not limited to preparation, copying, postage, delivery fees, expenses associated with any demonstrations or presentations which may be required by the Authority or any other costs incurred in connection with or relating to its BID. All such costs and expenses will remain with the Bidder and the Authority shall not be liable in any manner whatsoever for the same or for any other costs or other expenses incurred by a Bidder in preparation or submission of the BID, regardless of the conduct or outcome of the Bidding Process.

\*\*\*\*\*

---

**(SECTION-II)**  
**INSTRUCTIONS TO BIDDERS &**  
**APPENDIX TO BID**

Section II: Instructions to Bidders

**Table of Clauses**

<b>Clause</b>	<b>A. General</b>	<b>Clause</b>	<b>D. Submission of Bids</b>
<b>1</b>	Scope of Bid	<b>19</b>	Sealing and Marking of Bids
		<b>20</b>	Deadline for Submission of Bids
<b>2</b>	Source of Funds	<b>21</b>	Late Bids
<b>3</b>	Eligible Bidders	<b>22</b>	Modification & Withdrawal of Bids
<b>4</b>	Qualification of the Bidder		<b>E. Bid Opening &amp; Evaluation</b>
<b>5</b>	One Bid per Bidder	<b>23</b>	Bid Opening
<b>6</b>	Cost of Bidding	<b>24</b>	Process to be Confidential
<b>7</b>	Site Visit	<b>25</b>	Clarification of Bids and Contracting the Employer
	<b>B. Bidding Documents</b>	<b>26</b>	Examination of bids and Determination of Responsiveness
<b>8</b>	Content of Bidding Documents	<b>27</b>	Correction of Errors
<b>9</b>	Clarification of Bidding Documents	<b>28</b>	Evaluation and Comparison of Financial Bids
<b>10</b>	Amendment of Bidding Documents	<b>29</b>	Price Preference
	<b>C. Preparation of Bids</b>		<b>F. Award of Contract</b>
<b>11</b>	Language of Bid	<b>30</b>	Award Criteria
<b>12</b>	Documents Comprising the Bid	<b>31</b>	Employer's Right to Accept any Bid and to Reject any or all Bids
<b>13</b>	Bid Prices	<b>32</b>	Notification of Award and signing of agreement
<b>14</b>	Currencies of Bid and Payment	<b>33</b>	Performance Security
<b>15</b>	Bid Validity	<b>34</b>	Advances
<b>16</b>	Earnest Money/ Bid Security/ Forfeiture/Debarment	<b>35</b>	Corrupt or Fraudulent Practices
<b>17</b>	Alternative Proposals by Bidders		
<b>18</b>	Format and Signing of Bid		

Section 2  
Instructions to Bidders (ITB)  
**A. General**

**1. Scope of Bid**

- 1.1 The Employer (i.e. **Managing Director**, National Highways & Infrastructure Development Corporation Ltd.) invites bids for “as described in these documents and referred to as “the works”. The name and identification number of the works is provided in the Notice Inviting Tender.
- 1.2 The successful Bidder will be expected to complete the Works by the intended Completion Date specified in the Section V of these documents (Conditions of Contract and Contract Data).
- 1.3 Throughout these Bidding Documents, the terms “bid” and “tender” and their derivatives (bidder/tenderer, bid/tender, bidding/tendering, etc.) are synonymous.

**2. Source of Funds**

- 2.1 The expenditure on this project will be met by NHIDCL.

**3. Eligible Bidders**

- 3.1 This Invitation for Bids is open to all bidders meeting the qualification requirements prescribed in this document. A bidder may be a natural person, private entity, partnership firm or a company.
- 3.2 Any entity which has been barred by the Central Government, or any entity controlled by it, from participating in any project and the bar subsists as on the date of Application, or has been declared by the Authority as non-performer/blacklisted would not be eligible to submit the bid.

**4. Qualification of the Bidder**

- 4.1 Deleted

- 4.2 All bidders shall furnish the following information and documents with their bids in Section-3, Qualification Information.

- (a) Scanned copies of original documents defining the constitution or legal status, place of registration, and principal place of business; scanned copy of written power of attorney of the signatory of the Bid to commit the Bidder; & original copy of Written Power of attorney to be submitted in the envelop form. (refer clause 12.2 of ITB).
- (b) Scanned copy of experience certificate/documentary evidence to support clause 14.4 b of ITB.
- (C) A certificate from Statutory Auditor/Chartered Accountant as a proof of net positive financial standing of the bidder.

- (c) Scanned copy of evidence of availability (either owned or leased or rented) of items of construction equipment named in Clause 4.4 B(b) (i).
- (j) Scanned copy of information regarding any litigation or arbitration during the last five years in which the Bidder is involved, the parties concerned, the disputed amount, and the present status;
- (k) Deleted
- (l) Deleted.

**4.3** Bids from joint ventures, consortiums, combination or any sort of arrangement between two or more than two entities are not allowed.

**4.4 A.** To qualify for award of the contract, each bidder in its name should have the following; -

- (a) *achieved an average annual financial turnover (in all classes of Incident Management works) equal to the amount indicated in NIT during last three years ending 31<sup>st</sup> March of the previous financial year duly certified by Chartered Accountant. (Notwithstanding anything to the contrary contained herein, in the event that the bid due date falls within three months of the closing of the latest financial years, it shall ignore such financial year for the purpose of the bid and furnish annual financial turnover w.r.t. 3 years preceding in last financial year).*

- (b) satisfactorily completed (not less than 90% of contract value), as a prime contractor (or as a nominated/approved subcontractor, provided further that all other qualification criteria are satisfied) similar works during last seven years ending last day of month previous to the one in which bids are invited, either of the following:

- i. three similar completed works costing not less than amount equal to 40% each of estimated cost.
- ii. two similar completed works costing not less than amount equal to 50% each of estimated cost.
- iii. one similar completed work costing not less than amount equals to 80% each of estimated cost.

*i (The similar works constitutes experience of Incident Management works on 2/4/6 lane highways)*

(Escalation factor as under shall be used to bring the value of such completed works to the level of current financial

year i.e., 2020-21) **Escalation factor** (for the cost of works completed during the last 7 years & financial figures required for the calculation of bid capacity) may be taken as follows:

Year	before
Multiplying Factor One	1.1
Two	1.21
Three	1.33
Four	1.46
Five	1.61
Six	1.77
Seven	1.95
(c)	Deleted
(d)	Deleted
(e)	Deleted

**4.4 B (a)** Each bidder must submit the scanned copies of following documents along with the submission:

- (i) An affidavit on a Stamp Paper, duly attested from the Notary Public, that the information furnished with the bid documents is correct in all respects; and
- (ii) Such other certificates as defined in Section- III.
- (iii) Failure to submit the certificates/documents as specified above shall make the bid non-responsive.

**(b)** Each bidder must demonstrate:

- (i) Evidence of availability (either owned or leased or rented) of the key equipments for this work as stated in the Appendix to ITB.
- (ii) Deleted.

**4.4.C** Deleted

**4.5** Sub-Contractors' experience and resources shall not be taken into account in determining the bidder's compliance with the qualifying criteria.

**4.6** Bidders who meet the minimum qualification criteria will be qualified only if their available bid capacity is more than the total bid value. The available bid capacity will be calculated as under:

$$\text{Assessed Available Bid capacity} = (A * N * 2.5 - B) \text{ Where}$$

A = Maximum value of incident management works executed in any one year during the last three years (escalation factor as specified in this section shall be used to bring the maximum value of incident management works to the level of current financial year i.e., 2020-21) taking into account the completed as well as works in progress.

N = Number of years prescribed for completion of the works for which bid is invited.

B = Value (escalation factor as specified in this section shall be used to bring the value to the level of current financial year i.e., 2020-21) of existing commitments and on-going works to be completed during the next four months (period of completion of the works for which bid is invited)

- 4.7** Even though the bidders meet the above qualifying criteria, they are subject to be disqualified if they have:
- (i) made misleading or false representations in the forms, statements, affidavits and attachments submitted in proof of the qualification requirements; and/or
  - (ii) record of poor performance such as abandoning the works, not properly completing the contract, inordinate delays in completion, litigation history, or financial failures etc. or debarred from MoRT&H/NHA/NHIDCL work etc.
  - (iii) tampered the bid document in any manner.

## **5. One Bid per Bidder**

- 5.1** Each Bidder shall submit only one Bid for the work. A Bidder who submits more than one Bid will cause such bids to be disqualified.

## **6. Cost of Bidding**

- 6.1** The Bidder shall bear all costs associated with the preparation and submission of his Bid, and the Employer will, in no case, be responsible or liable for those costs.

## **7. Site Visit**

- 7.1** The Bidder, at his own cost, responsibility and risk, is encouraged to visit, examine and familiarize himself with the Site of Works and its surroundings including source of earth, water, road aggregates etc. and obtain all information that may be necessary for preparing the Bid and entering into a contract for construction of the Works. The costs of visiting the Site shall be at the Bidder's own expense. **He may contact the Office of the Executive Director, National Highways & Infrastructure Corporation Ltd, Regional Office Agartala in this regard.**

## **Section 2 Instructions to Bidders (ITB)**

### **B. Bidding Documents (On line)**

#### **8. Content of Bidding Documents**

**8.1** The set of bidding documents comprises the documents listed below and addenda (if any) issued in accordance with Clause 10:

##### **Volume- I:-**

1. Notice Inviting Tender
2. Instructions to Bidders & Appendix to Bid
3. Qualification Information
4. Forms Bank Guarantee, Agreement & LOA
5. Conditions of Contract & Contract Data
6. Scope of Work
7. Technical Specifications

##### **Volume - II:-**

**Bill of quantities:** Bidders will be required to quote each item rate on monthly basis (Should be filled in the prescribed format given in the bid document)

**8.2** DELETED

**8.3** The bidder is expected to examine carefully all instructions, conditions of contract, contract data, forms, terms, specifications, bill of quantities, etc. in the Bid Document. Failure to comply with the requirements of Bid Documents shall be at the bidder's own risk. Pursuant to clause 26 hereof, bids, which are not substantially responsive to the requirements of the Bid Documents, shall be rejected.

#### **9. Clarifications on Bid Documents**

**9.1** A prospective Bidder requiring any clarification on the bid document may notify the Employer in writing or by e-mail (scanned copy) at the Employer's address indicated in the Notice Inviting Tender. The Employer will respond to any request for clarification received earlier than 10 days prior to the deadline for submission of bids. Copies of the Employer's response will be hosted on website or which are required in the opinion of the Employer including a description of the enquiry, but without identifying its source.

**9.2.1 Deleted**

#### **10. Amendment of Bidding Documents**

**10.1** Before the deadline for submission of bids, the Employer may modify the Bidding Documents by issuing addenda.

- 10.2** Any addendum thus issued shall be part of the Bidding Documents and shall be hosted on NHIDCL Tendering portal. Bidders are advised to keep themselves updated of all the addendums issued on portal by daily checking the tendering portal and NHIDCL does not assume any responsibility in case the bidder fails to do so and does not take any action, if required, with respect to any relevant addendum.
- 10.3** To give prospective bidders reasonable time to take an addendum into account in preparing their bids, the Employer shall extend, as necessary, the deadline for submission of bids, in accordance with Clause 20.2.

**Section 2**  
**Instructions to Bidders (ITB)**  
**C. Preparation of Bids**

**11. Language of Bid**

- 11.1** All documents relating to the Bid shall be in English.

**12. Documents Comprising the Bid**

- 12.1** The bid submitted by the bidder shall be in two separate parts. Part-I This shall be named Technical Bid and shall comprise of information submitted in section-III. Part-II It shall be named Financial Bid and shall comprise of Priced bill of quantities.
- 12.2** Documents to be submitted in closed envelope before bid due date.

The copies of following documents is also required to be submitted during submission of bid, As per clause 12.1 above

- a) EMD/Bid Security
  - b) Bid Document Fee
  - c) Written Power of Attorney of the signatory of the bidder to commit the bid
  - d) Affidavit duly notarized (as per the format provided in Section III)
  - e) Original experience certificate or notarised copy of certificate duly signed by authorized signatory.
  - f) Undertakings and other details mentioned in Section III (Qualification Information) of this document.
- 
- **The uploaded documents through online will be taken into consideration for evaluation of bids.**

**12.3** The following documents, which are not submitted with the bid, will be deemed to be part of the bid.

Section	Particulars
1	Notice Inviting Tender
2	Instruction to the Bidders
3	Conditions of Contract
4	Contract Data
5	Scope of Work
6	Technical Specifications

### **13. Bid Prices**

**13.1** The Contract shall be for the whole works, as described in Clause 1. 1 based on the priced Bill of Quantities submitted by the Bidder.

**13.2** The bidder shall quote bid prices on appropriate format enclosed as part of tender document on tender portal of NHIDCL. The items for which no rate or price is entered by the Bidder will be required to be executed free of cost and shall be deemed covered under the other rates and prices in the Bill of Quantities quoted.

**13.3** All duties, taxes, royalties and other levies payable by the Contractor under the Contract, or for any other cause, shall be included in the rates, prices, and total Bid price submitted by the Bidder. **The GST shall be reimbursed (if applicable) subject to production of proof of such payment by the contractor specific to the subject work.**

13.4 The rates and prices quoted by the Bidder are subject to adjustment during the performance of the contract in accordance with the provisions of Clause 43 of the Conditions of Contract (no adjustment on any account will be admissible for contracts upto 12 month period).

### **14. Currencies of Bid and Payment**

**14.1** The unit rates and the prices shall be quoted by the bidder entirely in Indian Rupees. All payments shall be made in Indian Rupees.

### **15. Bid Validity**

**15.1** Bids shall remain valid for a period of 120 days after the deadline date for bid submission specified in Clause 20. A bid valid for a shorter period shall be rejected by the Employer as non-responsive.

**15.2** In exceptional circumstances, prior to expiry of the original time limit, the Employer may request that the bidders may extend the period of validity for a specified additional period. The request and the bidders' responses shall be made in writing or by cable. A bidder may refuse the request without forfeiting his bid security. A bidder agreeing to the request will not be required or permitted to modify his bid, but will be required to extend the validity of his bid security for a period of the extension, and in compliance with Clause 16 in all respects.

**16. Earnest Money / Bid Security/ Forfeiture/ Debarment**

**16.1** The Bidder shall furnish, as part of the Bid, Earnest Money/Bid Security, in the amount as specified in the NIT. (The Bank Guarantee/ Online Mode must be in favour of NHIDCL PROJECT ACCOUNT payable at Agartala (The bidder can make online payment of tender document fee, bid security through RTGS/ NEFT in the project Account ED (P)).

The Bid Security of unsuccessful bidder will be returned within 28 (twenty eight) days of the end of the bid validity period specified in sub clause of 18.1 of ITB or award of Contract whichever is earlier.

The bid security of the successful bidder will be discharged when the bidder has signed the LOA/Contract and furnished the required Performance Security.

**16.2 The Earnest Money shall, at the Bidder's option, be in the form of Bank Guarantee** of any scheduled commercial bank approved by RBI having a net worth of not less than Rs.500 crore as per the latest annual report of the bank must be in the name of Employer. In case of foreign bank (issued by a branch in India) the net worth in respect of the Indian operations shall only be taken into account. It shall be valid for 45 days beyond the validity of the bid. **Any bid having bid security for lesser value and shorter validity period shall be treated as non-responsive.**

**For Submission in BG Form:** Upload Copy of Bank Guarantee during Online submission of Bid.

**For Submission in Online Form:** Payment should be made on or prior to last date & time of submission of bid documents. If Bank Guarantee is submitted towards Bid Security/EMD, it should be linked in SFMS (Structured Finance Messaging System) with the following NHIDCL Bank account:

Account Name : Executive Director,NHIDCL,AGARTALA  
Bank Account No. : 79901010002266  
Bank & Branch : Syndicate Bank,Agartala  
IFSC Code : SYNB0007990

- A. Bank Guarantee in the name of the Employer, from following banks would be accepted:-
- i. State Bank of India or its subsidiaries,

- ii. Any Indian Nationalised Bank
- iii. IDBI / ICICI Bank
- iv. A Foreign Bank (issued by a branch outside India) with a counter guarantee from SBI or its subsidiaries or any Indian Nationalised Bank.
- v. Any Scheduled Commercial Bank approved by RBI having a net worth of not less than Rs. 500 crores as per the latest Annual Report of the Bank. In the case of a Foreign Bank (issued by a branch in India), the net worth in respect of the Indian operations shall only be taken into account.

B. The acceptance of the guarantees shall also be subject to the following conditions:-

- i. The capital adequacy of the Bank shall not be less than the norms prescribed by RBI (presently 9, with effect from 31<sup>st</sup> March, 2003,).
- ii. The bank guarantee issued by a Cooperative Bank shall not be accepted.

**16.3** Any bid not accompanied by an acceptable Earnest Money, shall be rejected by the Employer as non-responsive.

**16.4** The Earnest Money of unsuccessful bidders will be returned within 28 days of the end of the Bid validity period specified in Sub-Clause 15.1.

**16.5** The Earnest Money of the successful Bidder will be discharged when the Bidder has signed the Agreement and furnished the required Performance Security.

**16.6** The Bid Security / Earnest Money will be forfeited:

- a) if the Bidder withdraws the Bid after its submission during the period of Bid validity;
- b) in the case of a successful Bidder, if the Bidder fails within the specified time limit to
  - i. sign the Agreement; and/or
  - ii. furnish the required Performance Security.

**16.7** In case of forfeiture of bid security, the bidder shall also be debarred from participation in NHIDCI works for a period as decided by NHIDCL or minimum of 1 year whichever is higher.

## **17. Alternative Proposals by Bidders**

**17.1** Bidder shall submit offers that fully comply with the requirement of the Bidding Documents. Conditional offer or alternate offer will not be considered further in the process of evaluation and the bid will be declared non-responsive.

## **18. Format and Signing of Bid**

**18.1** The Bidder shall submit e-bid comprising of the documents as described in Clause 12 of the ITB.

**18.2** DELETED.

**18.3** DELETED.

**18.4** The documents to be submitted in the envelope form along with the document fee and Bid Security shall be typed or written in ink and shall be signed by a person duly authorized to sign on behalf of the bidder. All the pages of the documents as mentioned here shall be signed by the person/persons signing the bid. Documents as mentioned here shall contain no overwriting, alterations or additions, except those to comply with instructions, issued by the employer or as necessary to correct errors made by the bidder, in which case such corrections shall be made by scoring out the cancelled portion, writing the correction and signing and dating it along with the stamp by the person or persons signing the Bid

**Section 2**  
**Instructions to Bidders (ITB)**  
**D. Submission of Bids**

**19. Marking of Bids**

19.1 The documents to be submitted in Envelope only as per clause 12.2 of ITB.

**19.2 DELETED.**

**19.3 DELETED.**

**19.4 DELETED.**

**19.5 DELETED.**

**20. Deadline for Submission of Bids**

20.1 The Bidder shall ensure that the complete Bid is Submitted to on or before the Bid Due Date before the time specified in NIT/e-portal.

In the event of the specified date for the submission of documents in Envelope being declared a holiday for the Employer, the same will be received up to the specified time on the next working day.

20.2 **NHIDCL assumes no responsibility for inability of a bidder to submit bids through NHIDCL envelope on account of delay in submission at bidder's end. Bidder shall ensure that they submit the bid well before the "Due Date & Time of Bid-Submission". NHIDCL shall not be responsible if bidder is not able to submit the bid on account of failure in network/internet connection or any other technical reason.**

20.3 The Employer may extend the deadline for submission of bids by issuing an amendment in accordance with Clause 10, in which case all rights and obligations of the Employer and the bidders previously subject to the original deadline will then be subject to the new deadline.

**21. Late Submission of Document :**

21.1 Any document in envelope form if received by the Employer after the deadline prescribed in Clause 20 will be unopened to the Bidder and also the bid submitted by such bidder shall not be considered.

**22. Modification and Withdrawal of Bids**

22.1 Bidders may withdraw their bids as directed, before the Bid Due Date and time as prescribed in Clause 20.

**22.2** DELETED.

**22.3** No bid may be modified after the deadline for submission of bids.

**22.4** Withdrawal or modification of a Bid between the deadline for submission of bids and the expiration of the original period of bid validity specified in Clause 15.1 above or as extended pursuant to Clause 15.2 shall result in the forfeiture of the Bid security pursuant to Clause 16.

**22.5** Bidders may modify the prices of their bids before deadline of submission of bid.

**22.6** No Late and delayed bids after Bid Due date/time shall be permitted in. Time being displayed on our Portal shall be final and binding on bidder and bids have to be submitted by bidders considering this time only and not the time as per their location/country.

Section 2  
Instructions to Bidders (ITB)

**Bid Opening and Evaluation**

**23. Bid Opening**

Bid opening shall be carried out in two stages. Firstly, 'Technical Bid' of all the bids received (except those received late) shall be opened on the date and time mentioned in Notice Inviting Tender (NIT). 'Financial Bid' of those bidders whose technical bid has been determined to be substantially responsive shall be opened on a subsequent date through process of tendering, which will be notified to such bidders.

23.1 The Employer will open the "Technical Bid" of all the bids received (except those received late), in the presence of the bidders/bidders' representatives who choose to attend at the time, date and place specified in the **NIT**. In the event of the specified date for the submission of bids being declared a holiday for the Employer, the Bids will be opened at the appointed time and location on the next working day.

23.1.1 DELETED

23.1.2 DELETED

23.2 In all cases, the amount of Earnest Money, forms and validity shall be announced. Thereafter, the Employer at the opening as the Employer may consider appropriate, will announce the bidders' names and such other details.

23.3 The Employer will prepare minutes of the Bid opening, including the information disclosed to those present in accordance with Clause 23.1.

23.4 (i) The bids accompanied with valid bid security, bid document fee, will be taken up for evaluation with respect to the Qualification Information and other information furnished in Part I of the bid pursuant to Clause 12.1.

(ii) Deleted

(iii) Deleted

(iv) As soon as possible, the Evaluation Committee will finalize the list of responsive bidders whose financial bids are eligible for consideration. However, to assist in the examination, evaluation of technical bids, the Employer may at his discretion, asks any bidder for clarification of his bid however, no additional documents in support of clarification will be entertained.

23.5 The Employer shall inform the bidders, whose technical bids are found responsive, of the date, time and place of opening of the financial bids. The bidders so informed, or their representative, may attend the meeting of opening of financial bids.

23.6 At the time of the opening of the 'Financial Bid', the names of the bidders whose bids were found responsive in accordance with clause 23.5 will be announced. The financial bids of only these bidders will be opened. The responsive bidders' names, the Bid prices, the total amount of each bid, pursuant to clause 22 and such other details as the Employer may consider appropriate will be announced by the Employer at the time of bid opening. Any Bid price, which is not read out and recorded, will not be taken into account in Bid Evaluation.

23.7 The Employer shall prepare the minutes of the opening of the Financial Bids.

#### **24. Process to be Confidential**

24.1 Information relating to the examination, clarification, evaluation, and comparison of bids and recommendations for the award of a contract shall not be disclosed to bidders or any other person not officially concerned with such process until the award to the successful Bidder has been announced. Any attempt by a Bidder to influence the Employer's processing of bids or award decisions may result in the rejection of his Bid

#### **25. Clarification of Bids and Contacting the Employer**

25.1. To assist in the examination, evaluation, and comparison of Bids, the Employer may, at his discretion, ask any Bidder for clarification of his-Bid, including breakdowns of unit rates. The request for clarification and the response shall be in writing or by cable, but no change in the price or substance of the Bid shall be sought, offered, or permitted except as required to confirm the correction of arithmetic errors discovered by the Employer in the evaluation of the Bids in accordance with Clause 27.

25.2 Subject to sub-clause 25.1, no Bidder shall contact the Employer on any matter relating to his bid from the time of the bid opening to the time the contract is awarded. If the Bidder wishes to bring additional information to the notice of the Employer, it should do so in writing.

25.3 Any effort by the Bidder to influence the Employer in the Employer's bid evaluation, bid comparison or contract award decisions may result in the rejection of the Bidders' bid.

#### **26. Examination of Bids and Determination of Responsiveness**

26.1 During the detailed evaluation of "Technical Bids", the Employer will determine whether each Bid

(a) meets the eligibility criteria defined in Clauses 3 and 4;

(b) the required documents in envelop form submitted by the bidder as well as the documents Submitted by the bidder are in order; and

(c) is substantially responsive to the requirements of the Bidding Documents. During the detailed evaluation of the "Financial Bids", the responsiveness of the bids will be further determined with respect to the remaining bid conditions, i.e., priced bill of quantities, technical specifications and drawings etc.

26.2 DELETED.

26.3 DELETED.

27. DELETED.

**28. Evaluation and Comparison of Financial Bids**

28.1 The Employer will evaluate and compare only the bids determined to be substantially responsive in accordance with Clause 26.

DELETED

**28.3** If the Bid of the successful Bidder is seriously unbalanced in relation to the Engineer's/Employer's estimate of the cost of work to be performed under the contract, the Employer may require the Bidder to produce detailed price analyses for any or all items of the Bill of Quantities, to demonstrate the internal consistency of those prices with the construction methods and schedule proposed. After evaluation of the price analyses, the Employer may require that the amount of the performance security set forth in Clause 33 be increased and an additional performance security may be obtained at the expense of the successful Bidder to a level sufficient to protect the Employer against financial loss in the event of default of the successful Bidder under the Contract. The amount of the additional increased performance security as decided by the Employer shall be final, binding and conclusive on the bidder.

**28.4** A bid, which contains several items in the Bill of Quantities which are unrealistically priced low and which cannot be substantiated satisfactorily by the bidder, may be rejected as non-responsive.

**29. Price preference**

29.1 DELETED

Section 2  
Instructions to Bidders (ITB)

**F. Award of Contract**

**30. Award Criteria**

- 30.1** Subject to Clause 32, the Employer will award the Contract to the Bidder whose Bid has been determined:
- (i) to be substantially responsive to the bidding documents and who has offered the lowest evaluated Bid price.
  - (ii) Deleted.

**31. Employer's Right to Accept any Bid and to Reject any or all Bids**

- 31.1** Notwithstanding Clause 30, the Employer reserves the right to accept or reject any Bid, and to cancel the bidding process and reject all bids, at any time prior to the award of Contract, without thereby incurring any liability to the affected Bidder or bidders or any obligation to inform the affected Bidder or bidders of the grounds for the Employer's action.

**32. Notification of Award and Signing of Agreement.**

- 32.1.1** The bidder whose Bid has been accepted will be notified of the award by the Employer prior to expiration of the Bid validity period by cable, telex or facsimile confirmed by registered letter. This letter (hereinafter and in the Part I *General Conditions of Contract* called the "Letter of Acceptance") will state the sum that the Employer will pay to the Contractor in consideration of the execution, completion and maintenance of the Works, and of routine maintenance of roads by the Contractor as prescribed by the Contract (hereinafter and in the Contract called the "Contract Price").
- 32.2.** The notification of award will constitute the formation of the Contract, subject only to the furnishing of a performance security in accordance with the provisions of Clause 33.
- 32.3.** The Agreement will incorporate all agreements between the Employer and the successful Bidder. It will be signed by the Employer and the successful Bidder after the performance security is furnished.
- 32.4** Upon furnishing by the successful Bidder of the Performance Security, the Employer will promptly notify the other Bidders that their Bids have been unsuccessful.

**33. Performance Security**

- 33.1** **Within 10 (ten) days after receipt of the Letter of Acceptance, the successful Bidder shall deliver to the Employer a Performance Security of Five percent (5%) of the Contract Price, valid for the period of 28 days after the completion of work and sign the Contract.**

**33.2** The performance security shall be either in the form of a Bank Guarantee in the name of the Employer, from a Bank as specified in case of earnest money / bid security.

**33.3** Failure of the successful bidder to comply with the requirement of sub-clause 33.1 shall constitute sufficient ground for cancellation of the award and forfeiture of the bid security and debarment for a period as specified in clause 16.7.

**33.4** Additional Performance Security shall be calculated as under:

(i) If the bid price offered by the Contractor is lower than 10% but upto 20% of the Estimated Project Cost, then the Additional Performance Security shall be calculated @ 20% of the difference in the (a) Estimated Project Cost (as mentioned in RFP)-10% of the Estimated Project Cost and (b) the Bid Price offered by the selected Bidder.

(ii) If the bid price offered by the Contractor is lower than 20% of the Estimated Project Cost, then the Additional Performance Security shall be calculated @ 30% of the difference in the (a) Estimated Project Cost (as mentioned in RFP)-10% of the Estimated Project Cost and (b) the Bid Price offered by the selected Bidder

(iii) The Additional Performance Security shall be valid until 28 (twenty-eight) days after the issue of Completion Certificate under this Agreement.

(iv) The Additional Performance Security shall not be treated as part of the Performance Security and shall be released after issuing taking-over certificate as per Contract Agreement

**33.5** The performance security shall be either in the form of a Bank Guarantee in the name of the Employer, from a Bank as specified in case of earnest money / bid security. The Guarantor/Bank hereby confirms that BG shall be on the SFMS (Structural Finance Messaging System) platform and shall invariably send an advice of this Bank Guarantee to the designated bank of NHIDCL after obtaining details thereof from NHIDCL.

**33.6** Failure of the successful bidder to comply with the requirement of sub clause 33.1 shall constitute sufficient ground for cancellation of the award and forfeiture of the bid security and debarment for a period as specified in clause 16.7.

## **34. Advances**

**34.1** The Employer will not provide any Mobilization Advance for the Contract Package.

## **35. Corrupt or Fraudulent Practices**

**35.1** The bidder and their respective officers, employees, agents and advisers shall observe the highest standard of ethics during the bidding process. Notwithstanding anything to the contrary contained herein, the Employer may reject any bid without being liable in any manner whatsoever to the bidder if it determines that the bidder has, directly or indirectly or through an agent, engaged in corrupt practice, fraudulent practice, coercive practice, undesirable practice or restrictive practice in the bidding process.

35.2 Without prejudice to the rights of the Employer under Clause 35 hereinabove, if an bidder is found by the Employer to have directly or indirectly or through an agent, engaged or indulged in any corrupt practice, fraudulent practice, coercive practice, undesirable practice or restrictive practice during the bidding process, such bidder shall not be eligible to participate in any tender issued by the Employer during a period of 2 (two) years from the date such bidder is found by the Employer to have directly or indirectly or through an agent, engaged or indulged in any corrupt practice, fraudulent practice, coercive practice, undesirable practice or restrictive practice, as the case may be.

35.3 For the purposes of this Clause 35, the following terms shall have the meaning hereinafter respectively assigned to them:

- (a) "corrupt practice" means the offering, giving, receiving, or soliciting, directly or indirectly, of anything of value to influence the actions of any person connected with the bidding process (for avoidance of doubt, offering of employment to, or employing, or engaging in any manner whatsoever, directly or indirectly, any official of the Employer who is or has been associated in any manner, directly or indirectly, with the bidding process or has dealt with matters concerning the Contract or arising therefrom, before or after the execution thereof, at any time prior to the expiry of one year from the date such official resigns or retires from or otherwise ceases to be in the service of the Employer, shall be deemed to constitute influencing the actions of a person connected with the bidding process); engaging in any manner whatsoever, whether during the bidding process or after the award or after the execution of the Contract, as the case may be, any person in respect of any matter relating to the Works, who at any time has been or is a legal, financial or technical adviser of the Employer in relation to any matter concerning the Works;
- (b) "Fraudulent practice" means a misrepresentation or omission of facts or suppression of facts or disclosure of incomplete facts, in order to influence the bidding process;
- (c) "Coercive practice" means impairing or harming or threatening to impair or harm, directly or indirectly, any person or property to influence any person's participation or action in the bidding process;
- (d) "undesirable practice" means establishing contact with any person connected with or employed or engaged by the Employer with the objective of canvassing, lobbying or in any manner influencing or attempting to influence the bidding process; and
- (d) "Restrictive practice" means forming a cartel or arriving at any understanding or arrangement among bidder with the objective of restricting or manipulating a full and fair competition in the bidding process.

### Appendix to bid

(4.4. B) (b)(i) The key equipments to be deployed on contract work.

Name of the Equipment	Quantity	Duration (in months)
Crane of 20 Tonne Capacity	2	6 or upto 31.03.2021, whichever is earlier.
Patrol Vehicle	2	
Ambulance	2	
JCB	2	

**Note: The bidder must submit copy of the documentary evidence in support of his owning/leased/ rented of the above equipments.**

4.4 B (b) (ii)

The Number of Technical Personnel, Qualifications and Experience will be as follows :

Sl. No.	Personnel	Minimum Qualification and Experience	Particular Experience (minimum requirement)	No. of Persons
1.	Incident cum Road Property Manager cum Route Operation Manager	Graduate from a recognized University + 5 yrs. Exp.	3 years on highway property management and maintenance	2 (one for each Incident Management centre)

Note :The detailed and signed CV"s of the Key Technical Personnel, recently signed (not older than 3 months from the due date of submission of bid) by the key personnel himself, must be furnished **along with the bid as per** proforma given below. Non compliance of the above or non furnishing of the CV as above or conditional deployment of any of the above personnel or proposal to employ lesser number of personnel than above may make the bid non responsive and financial bid may not be opened.

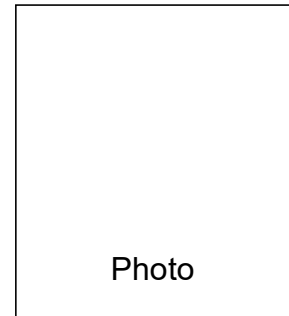

**Format of Curriculum Vitae (CV) For Proposed Key Staff**

1. Proposed Position: \_\_\_\_\_
2. Name of Staff: \_\_\_\_\_
3. Date of Birth : \_\_\_\_\_ **(Please furnish proof of age)**
4. Nationality: \_\_\_\_\_
5. Educational Qualification:  
*(Summarize college/university and other specialized education of staff member, giving names of schools, dates attended and degrees obtained). (Please furnish proof of qualification)*  
Contact Address with Phone and mobile numbers: \_\_\_\_\_
6. Membership of Professional Societies: \_\_\_\_\_
7. Publication: (List of details of major technical reports/papers published in recognized national and international journals)
8. **Employment Record:**  
(Starting with present position, list in reversed order, every employment held. List all positions held by staff member since graduation, giving dates, names of employing organization, title of positions held and location of assignments. For experience ***period of specific assignment must be clearly mentioned***, also give client references, where appropriate).
9. Summary of the CV

(Furnish a summary of the above CV. The information in the summary shall be precise and accurate. The information in the summary will have bearing on the evaluation of the CV).

A) Education:

- i) Field of Diploma/Graduation and year
- ii) Field of post graduation and year
- iii) Any other specific qualification

B) Experience

- i) Total experience in highways: \_\_\_\_\_ Yrs
- ii) Responsibilities held :
  - i) \_\_\_\_\_ Yrs.
  - ii) \_\_\_\_\_ Yrs.
  - iii) \_\_\_\_\_ Yrs.
  - iv) Relevant Experience: \_\_\_\_\_ Yrs.

C) Permanent Employment with the Firm (Yes/No): If

yes, how many years :  
If no, what is the employment :  
Arrangement with the firm ?

Certification:

- 1 *I am willing to work on the project and I will be available for entire duration of the project assignment and I will not engage myself in any other assignment during the currency of this assignment on the project*
- 2 I, the undersigned, certify that to the best of my knowledge and belief, this bio-data correctly describes myself my qualification and my experience.

Signature of the Candidate \_\_\_\_\_

Place\_ Date \_

Signature of the Authorized Representative of the firm \_\_\_\_\_

Place\_ Date\_

**Note:** Each page of the CV shall be signed in **ink** by both the staff member and the Authorized Representative of the firm.

---

**(SECTION-III)**

**QUALIFICATION INFORMATION**

**(TO BE FILLED BY BIDDER)**

**SECTION III**

**QUALIFICATION INFORMATION**

The information to be filled in by the Bidder in this section & document submitted in envelop form will be used for the purposes of post qualification as provided for in Clause 4 of the Instructions to Bidders. This information will not be incorporated in the Contract.

## Details of Bidder

1.
  - a) Name:
  - b) Country of incorporation:
  - c) Date of Constitution:
  - d) Legal Status of Bidder (Proprietorship, Partnership or Pvt. Ltd., Firm, Society etc.,) (Scanned copy of Original):
  - e) Place of Registration:
  - f) Principal Business:
  - g) Principal Place of business:
  - h) Corporate Identity Number/Registration No.
  
2. Brief Description of the Bidder including details of its main lines of business and proposed role and responsibilities in this project.
  
3. Details of individual(s) who will serve as the point of Contract/communication with the NHIDCL:
  - a) Name:
  - b) Designation:
  - c) Passport No./PAN/Aadhar No.:
  - d) Company:
  - e) Address:
  - f) Telephone No:
  - g) E-mail address:
  - h) Fax No.:
  
4. Particulars of the Authorized Signatory of the bidder:
  - a) Name:
  - b) Designation
  - c) Passport No./PAN/Aadhar No.:
  - d) Address:
  - e) Phone No.:
  - f) Fax No:
  - g) Class III Digital Signature Certificate ID no.

(Sign of Authorized Signatory of the bidder)

Name:

Designation:

Seal:

Date:

Business Address:

5 (a) Work performed as prime contractor, work performed in the past as a nominated/approved sub- contractor provided further that all other qualification criteria are satisfied (in the same name) of a similar nature (Incident Management works) during the last seven years as per ITB Clause 4.4A(b).

Project Name	Name of the Employer*	Description of work	Contract No.	Value of Contract (Rs. Crore)	Date of issue of work order	Stipulated period of completion	Actual date of completion*	Remarks explaining reasons for delay & work Completed

*\* Upload certificate(s) from the Employer (to be given by an officer at the rank of Executive Engineer or equivalent)*

**Note:** In case of nominated/approved sub-contractor – a certificate from the Executive Engineer or equivalent of the Prime Employer should be obtained from whom an approval for subcontractor has been obtained.

5 (b) Information on Bid Capacity (works for which bids have been submitted and accepted and works which are yet to be completed) as on the date 7 days before the last date for bid submission (as per CI 4.6 of the ITB).

(i) Existing commitments and on-going works (B)

Description of works	Place & State	Contract No.	Name & Address of Employer	Value of Contract (Rs Cr)	Stipulated Period of Completion	Value of works* remaining to be completed in the next N years(Rs Cr)	Escalation factor	Anticipated date of completion	Escalated value of remaining work during completion period of work for which bids are invited
1	2	3	4	5	6	7	8	9	10

\* Upload certificate (s) from the Engineer(s)-in-Charge of the rank of Executive Engineer or equivalent.

(ii) Details of works for which bid submitted and accepted (i.e. where contract signing is pending)

Description of works	Place & State	Name & Address of Employer	Date of issue of Letter of Acceptance (LOA) *	Value given in LOA	Stipulated period for completion	Value of work during completion period of work for which bids are invited
1	2	3	4	5	6	7

\* Upload copy of LOA

(iii) Bid Capacity (Bidder shall calculate, mention his bid capacity and enclose the supporting calculation)

A = Rs..... lakh (enclose the details)

N = .....years

B = Rs. .... lakh (enclose the details)

Assessed Available Bid capacity = (A\* N\* 2.5 - B)

6. Availability of Key Equipment essential for carrying out the Works [Ref.

Clause 4.4(B)(b) (i)]. The Bidder should list all the information requested below.

Item of Equipment	Requirement		Availability Proposals			Page No of the proof attached.
	No.	Capacity	Owned/Leased rented	Nos./Capacity	Age/Condition	

Note : The bidder must upload the documentary evidence in support of his owning/leased/ rented of the above equipment. In case the bidder proposes to hire or take the above equipment on lease, he should, along with the lease/rent agreement, attach the proof of ownership of these equipment with the company/ entity from whom the equipment are proposed to be hired on lease/ rent.

7. Qualification and Experience of Key Personnel required for administration and execution of the Contract [Ref. Clause 4.4 (B) (b) (ii)]. Upload biographical data for technical personnel (Refer also to Cl. 4.2 (e) of Instruction to Bidders).

(Refer also to Sub Clause 9.1 of the Conditions of Contract).

Position	Name	Qualification	Total Professional Experience (Years)	Particular Experience (Years)

Note : The detailed and signed CV of the Key Technical Personnel, signed by the key personnel himself, must be uploaded along with the bid as per proforma given in Appendix to ITB. Non compliance of the above or non furnishing of the CV as above or conditional deployment of any of the above personnel or proposal to employ lesser number of personnel than above may make the bid non responsive and financial bid may not be opened.

**8. Information on litigation history in which the Bidder is involved.**

Other Party (ies)	Employer	Cause of Dispute	Amount involved	Remarks showing Present Status

9. Bidders should upload the scanned copy of the following affidavits/ undertakings as per formats enclosed hereinafter & also send original copy of Affidavit : -

- (i) Affidavit (it should be on stamp paper attested by Notary Public)
- (ii) Undertaking regarding minimum investment of cash towards working capital.
- (iii) Undertaking that the Bids shall remain valid for the period specified in Clause 15.1 of the ITB.

**AFFIDAVIT**

1. I, the undersigned, do hereby certify that all the statements and documents made in the enclosed attachments are true and correct.
  
2. The undersigned also hereby certifies that neither our firm M/s\_\_ have abandoned any work on National Highways in India nor any contract awarded to us for such works have been rescinded, during last five years prior to the date of this bid.
  
3. The undersigned hereby authorise(s) and request(s) any bank, person, firm or corporation to furnish pertinent information deemed necessary and requested by NHIDCL to verify this statement or regarding my (our) competence and general reputation.
  
4. The undersigned understands and agrees that further qualifying information may be requested, and agrees to furnish any such information at the request of the NHIDCL and within the prescribed time.

\_\_\_\_\_

(Signed by an Authorised Representative of the Firm)

Name of the Representative

\_\_\_\_\_

Name of Firm

\_\_\_\_\_

\_\_\_\_\_

DATE

To be notarized by Notary

## UNDERTAKING

I, the undersigned do hereby undertake that our firm M/s \_\_\_\_\_ would invest a minimum cash up to 25% of the value of the work during implementation of the Contract towards the working capital.

\_\_\_\_\_

(Signed by an Authorised Representative of the Firm)

\_\_\_\_\_

Name of the Representative

\_\_\_\_\_

Name of Firm

\_\_\_\_\_

DATE

Note : It should not be later than one month before bid due date.

**UNDERTAKING**

I, the undersigned do hereby undertake that our firm M/s

\_\_\_\_\_ agree to abide by this bid for a period of \_days after the date fixed for receiving the same and it shall be binding on us and may be accepted at any time before the expiration of that period.

\_\_\_\_\_

(Signed by an Authorised Representative of the Firm)

Name of the Representative

\_\_\_\_\_

Name of Firm

\_\_\_\_\_

\_\_\_\_\_

DATE

Note : It should not be later than one month before bid due date.

(On the letter head of the bidder)

**Appendix 1.7**

[Ref. clause 4.4 B (b) (i)]

**Undertaking**

I, the undersigned do hereby undertake that our firm  
M/s.....agree to provide and will  
deploy required equipment as mentioned in the Appendix to ITB of the work  
.....

Further it is certified that the documents submitted as an evidence of availability  
of the key equipments for this work as stated in the Appendix to ITB, are genuine  
and correct. If anything contrary to the details as submitted is found at any stage  
NHIDCL would be at liberty to debar/blacklist my firm for an appropriate period  
as decided by NHIDCL.

(Signed by an Authorized Representative of the Firm) \_\_\_\_\_

Name of the Representative \_\_\_\_\_

\_\_\_\_\_  
Name of Firm

(Seal of the company) \_\_\_\_\_

Note : It should not be later than one month before  
bid due date.

## UNDERTAKING

I, the undersigned do hereby undertake that our firm M/s \_\_\_\_\_  
agree to abide by this bid for a period of 120 days after the date fixed for receiving the same and  
it shall be binding on us and may be accepted at any time before the expiration of that period.

\_\_\_\_\_  
(Signed by an Authorised Representative of the Firm)

\_\_\_\_\_  
Name of the Representative

\_\_\_\_\_  
Name of Firm

\_\_\_\_\_  
DATE

---

**(SECTION-IV)**  
**FORMS OF BANK GUARANTEES**  
**LOA & AGREEMENT**

## FORM OF BANK GUARANTEE FOR BID SECURITY

To

The Executive Director,  
National Highways & Infrastructure Development Corporation Ltd.  
Regional Office, Agartala  
3rd Floor, UD Bhawan  
Near Ravindra Bhawan,  
Sakuntala Road, Aragtala  
Email : [edp-agartala@nhidcl.com](mailto:edp-agartala@nhidcl.com)

WHEREAS \_\_\_\_\_ (Name of Tenderer) (hereinafter called the Tenderer) wishes to submit his tender for \_\_\_\_\_ herein after called "the Tender" KNOW ALL MEN by these present that we \_\_\_\_\_ (Name of Bank) of \_\_\_\_\_ (Name of country) having our registered office at ( \_\_\_\_\_ ) (hereinafter called the 'Bank') are bound unto the National Highways Authority of India (hereinafter called "the Employer") in the sum of the Rs. \_\_\_\_\_ (Rupees \_\_\_\_\_) \*for which payment can truly be made to the said Employer. The Bank bind themselves, their successors and assigns by these present with the common seal of the Bank this day \_\_\_\_\_ of \_\_\_\_\_ and undertake to pay the amount of \_\_\_\_\_ Rs. \_\_\_\_\_ to the employer upon receipt of his first written demand without the employer having to substantiate his demand.

"This guarantee shall also be operatable at our \_\_\_\_\_ branch at New Delhi, from whom, confirmation regarding the issue of this guarantee or extension/renewal thereof shall be made available on demand. In the contingency of this guarantee being invoked and payment thereunder claimed, the said branch shall accept such invocation letter and make payment of amounts so demanded under the said invocation".

The conditions of this obligation are:

(i) If the tenderer withdraws his tender during the period of Tender validity specified in the Form of Tender.

Or

(ii) If the Tenderer having been notified of the acceptance of his Tender by the Employer during the period of tender validity.

(a) fails or refuses to execute the Form of Agreement in accordance with the instructions to bidders, if required; or

(b) fails or refuses to furnish the Performance Security, in accordance with the Instruction to Bidders.

We undertake to pay to the Employer upto the above amount upon receipt of his first written demand, without the employer having to substantiate his demand, provided that in his demand the Employer will note that the amount claimed by him is due to him owing to the occurrence of any one of the above conditions, specifying the occurred condition or conditions.

This guarantee will remain in force upto and including the date 45 days beyond the validity of the bid as stated in the Instructions to Bidders or as it may be extended by the Employer, at any time prior to the closing date for submission of the Tenders Notice of which extension to the Bank is hereby waived. Any demand in respect of this guarantee should be made on the Bank on or before the date of expiry of this guarantee.

Notwithstanding anything contained herein before, our liability under this guarantee is restricted to Rs. \_\_\_\_\_ (Rs. \_\_\_\_\_ in words) and the guarantee shall remain valid till \_\_\_\_\_. Unless a claim or a demand in writing is served upon us on or before \_\_\_\_\_ all our liability under this guarantee shall cease.

The Guarantor/bank hereby confirms that it is on the SFMS (Structural Finance Messaging System) platform & shall invariably send an advice of this Bank Guarantee to the designated bank of NHIDCL as detailed below:

Sl. No.	Particulars	Details
1.	Name of Beneficiary	NHIDCL, Project Account
2.	Name of Bank	Syndicate Bank, Agartala
3.	Account No.	79901010002266
4.	IFSC Code	SYNB0007990
5.	Address of Bank Branch	Syndicate Bank, above RMS office, 1st Floor, Durgabari Road Agartala-799001

SIGNATURE OF AUTHORISED REPRESENTATIVE OF THE BANK \_\_\_\_\_

NAME AND DESIGNATION \_\_\_\_\_ EMPLOYEE CODE NUMBER \_\_\_\_\_

SEAL OF THE BANK \_\_\_\_\_

SIGNATURE OF THE WITNESS (IF THIS IS TO BE WITNESSED AS PER BANK'S POLICY)

\_\_\_\_\_

NAME OF THE WITNESS \_\_\_\_\_

ADDRESS OF THE WITNESS \_\_\_\_\_

## FORM OF BANK GUARANTEE FOR PERFORMANCE SECURITY

To

The Executive Director,  
National Highways & Infrastructure Development Corporation Ltd.  
Regional Office, Agartala  
3rd Floor, UD Bhawan  
Near Ravindra Bhawan,  
Sakuntala Road, Aragtala  
Email : [edp-agartala@nhidcl.com](mailto:edp-agartala@nhidcl.com)

WHEREAS..... (name and address of contractor) hereinafter called “the contractor” has undertaken, in pursuance of Letter of Acceptance No. .... Dated ..... to execute..... (name of Contract and brief description of Works) (hereinafter called “the contract”).

AND WHEREAS it has been stipulated by you in the said contract that the Contractor shall furnish you with a Bank Guarantee for the sum specified therein as security for compliance with his obligations in accordance with the Contract;

AND WHEREAS we have agreed to give the Contractor such a Bank Guarantee:

NOW THEREOF we hereby affirm that we are the guarantor and responsible to you on behalf of the Contractor, up to a total of Rs..... (amount of guarantee) (Rupees..... (in words), , and we undertake to pay you, upon your first written demand and without cavil or argument, any sum or sums within the limits of ..... (amount of guarantee) as aforesaid without your needing to prove or to show grounds or reasons for your demand for the sum specified therein.

“This guarantee shall also be operatable at our \_\_\_\_\_ branch at New Delhi, from whom, confirmation regarding the issue of this guarantee or extension/renewal thereof shall be made available on demand. In the contingency of this guarantee being invoked and payment thereunder claimed, the said branch shall accept such invocation letter and make payment of amounts so demanded under the said invocation”.

We hereby waive the necessity of your demanding the said debt from the Contractor before presenting us with the demand.

We further agree that no change or addition to or other modification of the terms of the contract or of the works to be performed there under or of any of the contract documents which may be made between you and the Contractor shall in any way release us from any liability under this guarantee, and we hereby waive notice of any such change, addition or modification.

This guarantee shall be valid until 28 days from the date of expiry of the Defects Liability Period.

Notwithstanding anything contained herein before, our liability under this guarantee is restricted to Rs. \_\_\_\_\_ (Rs. \_\_\_\_\_ in words) and the guarantee shall remain valid till

\_\_\_\_\_. Unless a claim or a demand in writing is served upon us on or before \_\_\_\_\_ all our liability under this guarantee shall cease.

The Guarantor/bank hereby confirms that it is on the SFMS (Structural Finance Messaging System) platform & shall invariably send an advice of this Bank Guarantee to the designated bank of NHIDCL as detailed below:

Sl. No.	Particulars	Details
1.	Name of Beneficiary	NHIDCL, Project Account
2.	Name of Bank	Syndicate Bank, Agartala
3.	Account No.	79901010002266
4.	IFSC Code	SYNB0007990
5.	Address of Bank Branch	Syndicate Bank, above RMS office, 1 <sup>st</sup> Floor, Durgabari Road Agartala-799001

Signature and seal of the Guarantor with Name, Designation, Employee Code Number & Telephone Number.....

Name of the Issuing Bank/Branch .....Name of the Controlling Branch/Bank.....

Address & Telephone Number.....Address & Telephone Number.....

Date.....

In the presence of (if this is to be witnessed as per bank's policy).....

1. ....  
(Name, Address & Occupation)

2. ....  
(Name, Address & Occupation)

An amount shall be inserted by the Guarantor, representing the percentage of the Contract Price specified in the Contract including additional security for unbalance bids, if any and denominated in Indian Rupees.

## **FORM OF LETTER OF APPLICATION**

To,  
The Executive Director,  
National Highways & Infrastructure Development Corporation Ltd.  
Regional Office, Agartala  
3rd Floor, UD Bhawan  
Near Ravindra Bhawan,  
Sakuntala Road, Aragtala  
Email : [edp-agartala@nhidcl.com](mailto:edp-agartala@nhidcl.com)

**DESCRIPTION OF WORKS:** “Providing of incident Management Services (Route Patrol, Crane, Ambulance & JCB) for National Highways in the State of Tripura”.

Dear Sir,

Having examined the Bid Document, Instruction to Bidders Qualification Information, Scope of works, etc. for the subject work. We, hereby submit our bid for the subject work.

It is certified that the information furnished in this document is true and correct. The proposal is unconditional and unqualified. We undersigned accept that NHIDCL reserves the right to reject any or all application without assigning any reason.

Thanking you,

Yours faithfully,

(Authorized Signatory)  
for and on behalf of M/s \_\_\_\_\_

**FORM OF LETTER OF ACCEPTANCE**

No. ....

Dated .....

To

**M/s**.....

**Sub.:** ..... **Name of Work** .....

Sir,

Based on your bid submitted on ..... in compliance of bidding document of NMPRCL for execution of the work of ..... , it is hereby notified that your bid for a contract price of **Rs..... (Rupees in words.....)** has been accepted for and on behalf of NHIDCL.

You are hereby requested to furnish Performance Security plus additional security in the form detailed in para. 33.2 of ITB for an amount equivalent to **Rs..... (Rupees in words.....)** within 10 days as per provisions of clause 33.1 of ITB of the bid document and sign the contract agreement failing which the actions as stipulated in clause-.33.3 of ITB shall be taken.

Thanking you,

Yours faithfully,

(.....)

## FORM OF AGREEMENT

### AGREEMENT

This agreement made the \_\_\_\_\_ day of \_\_\_\_\_ 2020 \_\_\_\_\_ between the National Highways & Infrastructure Development Corporation Ltd., New Delhi (hereinafter called "the Employer" of the one part and \_\_\_\_\_ (here in after called "the Contractor") of the other part.

AND WHEREAS the Employer invited bids from eligible bidders for the execution of certain works, viz.,.....

AND WHEREAS pursuant to the bid submitted by the Contractor, vide \_\_\_\_\_ (here in after referred to as the "BID" or "ÖFFER") for the execution of works, the Employer by his letter of acceptance dated \_\_\_\_\_ accepted the offer submitted by the Contractor for the execution and completion of such works and remedying of any defects thereon, on terms and conditions in accordance with the documents listed in para 2 below.

AND WHEREAS the Contractor by a deed of undertaking dated \_\_\_\_\_ has agreed to abide by all the terms of the bid, including but not limited to the amount quoted for the execution of Contract, as stated in the bid, and also to comply with such terms and conditions as may be required from time to time.

AND WHEREAS the contractor has agreed to undertake such works and has furnished a performance security pursuant to clause 33 of the instructions to bidders (Section-I).

NOW THIS AGREEMENT WITNESSETH as follows:

1. In this agreement words and expressions shall have the same meaning as are respectively assigned to them in the conditions of contract hereinafter referred to;
2. the following documents shall be deemed to form and be read and construed as part of this agreement viz.
  - (a) Agreement,
  - (b) Letter of Acceptance
  - (c) Contractor's Bid,
  - (d) Contract Data,
  - (e) Conditions of Contract
  - (f) Technical Specifications,
  - (g) Drawings, if any
  - (i) Scope of Work
  - (j) Bill of Quantities, and
  - (k) Any other document listed in the Contract Data.
3. The foregoing documents shall be construed as complementary and mutually explanatory one with another. Should any ambiguity or discrepancy be noted then the order of precedence of these documents shall be subject to the order as listed above and interpreted in the above order of priority.
4. In consideration of the payments to be made by the Employer to the Contractor as hereinafter mentioned, the Contractor hereby covenants with the Employer to execute and complete the works and remedy any defects therein in conformity in all respects with the provisions of the contract.

5. the employer hereby covenants to pay the contractor in consideration of the execution and completion of the works and remedying of defects therein, the contract price or such other sum as may become payable under the provisions of the contract at the times and in the manner prescribed by the contract.

IN WITNESS WHEREOF the parties here to have caused this agreement to be executed the day and year above written. Signed, sealed and delivered by the said Employer through his Authorized Representative and the said Contractor through his Power of Attorney holder.

**Binding Signature of Employer** \_\_\_\_\_

For and on behalf of Managing Director,

National Highways & Infrastructure Development Corporation Ltd.,

New Delhi – 110 001

**Binding Signature of Contractor** \_\_\_\_\_

For and on behalf of M/s. \_\_\_\_\_

In the presence of

1. Name :

Address:

2. Name :

Address:

In the Presence of

1. Name:

Address:

2. Name:

Address:

---

**(SECTION-V)**  
**CONDITIONS OF CONTRACT**  
**AND CONTRACT DATA**

## Table of Clauses

<p><b>A. General</b></p> <ol style="list-style-type: none"><li>1. Definitions</li><li>2. Interpretation</li><li>3. Language and Law</li><li>4. Engineer's Decisions</li><li>5. Delegation</li><li>6. Communications</li><li>7. Subcontracting</li><li>8. Other Contractors</li><li>9. Personnel</li><li>10. Employer's and Contractor's Risks</li><li>11. Employer's Risks</li><li>12. Contractor's Risks</li><li>13. Insurance</li><li>14. Site Investigation Reports</li><li>15. Queries about the Contract Data</li><li>16. Contractor to Construct the Works &amp; do maintenance</li><li>17. The Works to Be Completed by the Intended Completion Date</li><li>18. Approval by the Engineer</li><li>19. Safety</li><li>20. Discoveries</li><li>21. Possession of the Site</li><li>22. Access to the Site</li><li>23. Instructions</li><li>24. Deleted</li><li>25. Arbitration</li><li>26. Deleted</li></ol> <p><b>B. Time Control</b></p> <ol style="list-style-type: none"><li>27. Programme</li><li>28. Extension of the Intended Completion Date</li><li>29. Delays Ordered by the Engineer</li><li>30. Management Meetings</li></ol> <p><b>C. Quality Control</b></p> <ol style="list-style-type: none"><li>31. Identifying Defects</li><li>32. Tests</li><li>33. Correction of Defects</li><li>34. Uncorrected Defects</li></ol>	<p><b>D. Cost Control</b></p> <ol style="list-style-type: none"><li>35. Bill of Quantities</li><li>36. Variations</li><li>37. Payments for Variations</li><li>38. Cash Flow Forecasts</li><li>39. Payment Certificates</li><li>40. Payments</li><li>41. Compensation Events</li><li>42. Taxes and currencies for payment</li><li>43. Price adjustment – Deleted</li><li>44. Security Deposit/ Retention Money</li><li>45. Liquidated Damages</li><li>46. Advance Payment</li><li>47. Securities</li><li>48. Cost of Repairs</li></ol> <p><b>E. Finishing the Contract</b></p> <ol style="list-style-type: none"><li>49. Completion</li><li>50. Taking Over</li><li>51. Final Account</li><li>52. Operating and Maintenance Manual</li><li>53. Termination</li><li>54. Payment upon Termination</li><li>55. Property</li><li>56. Release from Performance</li></ol> <p><b>F. Other Conditions of Contract</b></p> <ol style="list-style-type: none"><li>57. Labour</li><li>58. Compliance with Labour Regulations</li><li>59. Drawings and Photographs of the Works</li><li>60. The Apprenticeship Act, 1961</li></ol>
--	---

## **Section V Conditions of Contract**

### **A. General**

#### **1. Definitions**

- 1.1** Terms which are defined in the Contract Data are not defined in the Conditions of Contract but keep their defined meanings. Capital initials are used to identify defined terms.

**Bill of Quantities** means the priced and completed Bill of Quantities forming part of the Bid.

**Compensation Events** are those defined in Clause 41 hereunder.

**The Completion Date** is the date of completion of the Works as certified by the Engineer, in accordance with Clause 49.1.

**The Contract** is the Contract between the Employer and the Contractor to execute, complete, and maintain the Works. It consists of the documents listed in Clause 2.3.

**The Contract Data** defines the documents and other information, which comprise the Contract.

**The Contractor** is a person or corporate body whose Bid to carry out the Works has been accepted by the Employer.

**The Contractor's Bid** is the completed upon the submission of the Bid and subsequent submission of documents to be submitted in the form as required under the ITB.

**The Contract Price** is the price stated in the Letter of Acceptance and thereafter as adjusted in accordance with the provisions of the Contract.

**Days** are calendar days; months are calendar months.

A **Defect** is any part of the Works not completed in accordance with the Contract.

**The Employer** is the party as defined in the Contract Data, who employs the Contractor to carry out the Works. The Employer may delegate any or all of its functions to a person or body nominated by him for specified functions.

**The Engineer** is the person named in the Contract Data (or any other competent person appointed by the Employer and notified to the Contractor, to act in replacement of the Engineer) who is responsible for supervising the execution of the Works and administering the Contract.

**Equipment** is the Contractor's machinery and vehicles brought temporarily to the Site to construct the Works.

**The Initial Contract Price** is the Contract Price listed in the Employer's Letter of Acceptance.

**The Intended Completion Date** is the date on which it is intended that the Contractor shall complete the Works. The Intended Completion Date is specified in the Contract Data. The Intended Completion Date may be revised only by the Engineer by issuing an extension of time after the approval from Employer.

**Materials** are all supplies, including consumables, used by the Contractor for incorporation in the Works.

**Plant** is any integral part of the Works that shall have a mechanical, electrical, electronic, chemical, or biological function.

The **Site** is the area defined as such in the Contract Data.

**Site Investigation Reports** are those that were included in the bidding documents and are factual interpretative reports about the surface and subsurface conditions at the Site.

**Specification** means the Specification of the Works included in the Contract and any modification or addition made or approved by the Engineer.

The **Start Date** is given in the Contract Data. It is the date when the Contractor shall commence execution of the Works. It does not necessarily coincide with any of the Site Possession Dates.

A **Sub-Contractor** is a person or corporate body who has a Contract with the Contractor to carry out a part of the work in the Contract, which includes work on the Site.

**Temporary Works** are works designed, constructed, installed, and removed by the Contractor that are needed for construction or installation of the Works.

A **Variation** is an instruction given by the Engineer after the approval from NHIDCL, which varies the Works.

The **Works** are what the Contract requires the Contractor to construct, install, maintain, and handover to the Employer, as defined in the Contract Data.

## **2. Interpretation**

- 2.1** In interpreting these Conditions of Contract, singular also means plural, male also means female or neuter, and the other way around. Headings have no significance. Words have their normal meaning under the language of the Contract unless specifically defined. The Engineer will provide instructions clarifying queries about these Conditions of Contract.
- 2.2** If sectional completion is specified in the Contract Data, references in the Conditions of Contract to the Works, the Completion Date, and the Intended Completion Date apply to any Section of the Works (other than references to the Completion Date and Intended Completion Date for the whole of the Works).
- 2.3** The documents forming the Contract shall be interpreted in the following order of priority.
  - (a) Agreement,

- (b) Letter of Acceptance
- (c) Contractor's Bid,
- (d) Contract Data,
- (e) Conditions of Contract
- (f) Technical Specifications,
- (g) Drawings, if any
- (h) Scope of Work
- (i) Bill of Quantities, and
- (kj) Any other document listed in the Contract Data.

### **3. Language and Law**

- 3.1** The language of the Contract and the law governing the Contract are stated in the Contract Data.

### **4. Engineer's Decisions**

- 4.1** Except where otherwise specifically stated, the Engineer will decide contractual matters between the Employer and the Contractor in the role representing the Employer.

### **5. Delegation**

- 5.1** The Engineer, duly informing the Employer, may delegate any of his duties and responsibilities to other people except to the Adjudicator, after notifying the Contractor, and may cancel any delegation after notifying the Contractor.

### **6. Communications**

- 6.1** Communications between parties that are referred to in the Conditions shall be effective only when in writing. A notice shall be effective only when it is delivered.

## **7. Subcontracting**

**7.1** The Contractor may subcontract any portion of work, up to a limit specified in Contract Data, with the prior approval of the Employer in writing. Subcontracting shall not alter the Contractor's obligations.

**7.2** The Contractor shall not be required to obtain any consent from the Employer for:

- a. the sub-contracting of any part of the Works for which the Sub-Contractor is named in the Contract;
- b. the provision of labour or labour component.
- c. the purchase of Materials which are in accordance with the standards specified in the Contract.

**7.3** Beyond what has been stated in clauses 7.1 and 7.2, if the Contractor proposes sub-contracting of any part of the work during execution of the Works, because of some unforeseen circumstances to enable him to complete the Works as per terms of the Contract, the Employer will consider the following before according approval:

- a) The Contractor shall not sub-contract the Works more than the limit specified in Contract Data..
- b) The Contractor shall not sub-contract any part of the Work without prior consent of the Employer. Any such consent shall not relieve the Contractor from any liability or obligation under the Contract and he shall be responsible for the acts, defaults and neglects of any of his sub-Contractor, his agents or workmen as fully as if they were the acts, defaults or neglects of the Contractor, his agents and workmen.

**7.4** The Engineer should satisfy himself before recommending to the Employer whether

- a) The circumstances warrant such sub-contracting; and
- b) The sub-Contractor so proposed for the Work possess the experience, qualifications and equipment necessary for the job proposed to be entrusted to him in proportion to the quantum of Works to be sub-contracted.

## **8. Other Contractors**

**8.1** The Contractor shall cooperate and share the Site with other Contractors, public authorities, utilities, and the Employer between the dates given in the Schedule of Other Contractors, as referred to in the Contract Data. The Contractor shall also provide facilities and services for them as described in the Schedule. The Employer may modify the Schedule of Other Contractors, and shall notify the Contractor of any such modification.

**8.2** The Contractor should take up the works in convenient reaches as decided by the Engineer to ensure there is least hindrance to the smooth flow of traffic including movement of vehicles and equipment of other Contractors till the completion of the Works.

## **9. Personnel**

**9.1** The Contractor shall employ the technical personnel named in the Contract Data or other technical persons approved by the Engineer. The Engineer will approve any proposed replacement of technical personnel only if their relevant qualifications and experience are substantially equal to or better than those of the personnel stated in the Contract Data. If

the personnel stated in the contract data are not deployed on site by the contractor, it will be treated as a breach of contract and action will be taken as per clause 53.

- 9.2** If the Engineer asks the Contractor to remove a person who is a member of the Contractor's staff or work force, stating the reasons, the Contractor shall ensure that the person leaves the Site within seven days and has no further connection with the Works in the Contract.

## **10. Employer's and Contractor's Risks**

- 10.1** The Employer carries the risks which this Contract states are Employer's risks, and the Contractor carries the risks which this Contract states are Contractor's risks.

## **11. Employer's Risks**

- 11.1** The Employer is responsible for the excepted risks which are (a) in so far as they directly affect the execution of the Works in the Employer's country, the risks of war, hostilities, invasion, act of foreign enemies, rebellion, revolution, insurrection or military or usurped power, civil war, riot commotion or disorder (unless restricted to the Contractor's employees), natural calamities and contamination from any nuclear fuel or nuclear waste or radioactive toxic explosive.

## **12. Contractor's Risks**

- 12.1** All risks of loss of or damage to physical property and of personal injury and death, which arise during and in consequence of the performance of the Contract other than the excepted risks, referred to in clause 11.1, are the responsibility of the Contractor.

## **13. Insurance**

- 13.1** The Contractor at his cost shall provide, in the joint names of the Employer and the Contractor, insurance cover from the Start Date to the end of defect liability period for events (a) to (d), in the amounts and deductibles stated in the Contract Data for the following events which are due to the Contractor's risks:

- a) loss of or damage to the Works, Plant and Materials;
- b) loss of or damage to Equipment;
- c) loss of or damage to property (except the Works, Plant, Materials, and Equipment) in connection with the Contract; and
- d) Personal injury or death.

- 13.2** Insurance policies and certificates for insurance shall be delivered by the Contractor to the Engineer for the Engineer's approval before the Start Date. All such insurance shall provide for compensation to be payable in Indian Rupees to rectify the loss or damage incurred.

- 13.3** If the Contractor does not provide any of the policies and certificates required, the Employer may effect the insurance which the Contractor should have provided and recover the premiums the Employer has paid from payments otherwise due to the Contractor or, if no payment is due, the payment of the premiums shall be debt due.

- 13.4** Alterations to the terms of insurance shall not be made without the approval of the Engineer.

**13.4** Both parties shall comply with any conditions of the insurance policies.

**14. Site Investigation Reports**

**14.1** The Contractor, in preparing the Bid, may rely on any Site Investigation Reports referred to in the Contract Data, supplemented by any other information available to him, before submitting the bid.

**15. Queries about the Contract Data**

**15.** The Executive Director, NHIDCL, RO, Agartala will clarify queries on the Contract Data.

**16.** The Contractor shall construct, install and maintain the Works in accordance with the documents forming part of the contract.

**17. The Works to Be Completed by the Intended Completion Date**

**17.1** The Contractor may commence execution of the Works on the Start Date and shall carry out the Works in accordance with the Programme submitted by the Contractor, as updated with the approval of the Engineer, and complete them by the Intended Completion Date.

**18. Approval by the Engineer**

**18.1** The Contractor shall submit Specifications and Drawings showing the proposed Temporary Works to the Engineer, who is to approve them if they comply with specifications and drawings.

**18.2** The Contractor shall be responsible for design of Temporary Works.

**18.3** The Engineer's approval shall not alter the Contractor's responsibility for design of the Temporary Works.

**18.4** The Contractor shall obtain approval of third parties to the design of the Temporary Works, where required.

**18.5** All Drawings prepared by the Contractor for the execution of the temporary or permanent Works, are subject to prior approval by the Engineer before their use.

**19. Safety**

**19.1** The Contractor shall be responsible for the safety of all activities on the Site.

**20. Discoveries**

**20.1** Anything of historical or other interest or of significant value unexpectedly discovered on the Site shall be the property of the Employer. The Contractor shall notify the Engineer of such discoveries and carry out the Engineer's instructions for dealing with them.

## **21. Possession of the Site**

**21.1** The Employer shall give complete possession of the Site to the Contractor on the date of signing of agreement.

## **22. Access to the Site**

**22.1** The Contractor shall allow access to the Site and to any place where work in connection with the Contract is being carried out, or is intended to be carried out to the engineer and any person/persons/agency authorized by:

- a. The Engineer
- b. The Employer

## **23. Instructions**

**23.1** The Contractor shall carry out all instructions of the Engineer, which comply with the applicable laws where the Site is located.

**23.2** The Contractor shall permit the Employer to inspect the Contractor's accounts and records relating to the performance of the Contractor and to have them audited by Auditors appointed by the Employer if so required by the Employer.

## **24. DELETED**

## **25. ARBITRATION**

The procedure for arbitration will be as follows:

- (a) In case of Dispute or difference arising between the Employer and a domestic contractor relating to any matter arising out of or connected with this agreement, such disputes or difference shall be settled in accordance with the Arbitration and Conciliation Act, 1996. The arbitral tribunal shall consist of 3 arbitrators one each to be appointed by the Employer and the Contractor. The third Arbitrator shall be chosen by the two Arbitrators so appointed by the Parties and shall act as Presiding arbitrator. In case of failure of the two arbitrators appointed by the parties to reach upon a consensus within a period of 30 days from the appointment of the arbitrator appointed subsequently, the Presiding Arbitrator shall be appointed by the Secretary General of Indian Road Congress.
- (b) If one of the parties fails to appoint its arbitrator in pursuance of sub-clause (a) and (b) above within 30 days after receipt of the notice of the appointment of its arbitrator by the other party, then the Secretary General of Indian Road Congress shall appoint the arbitrator. A certified copy of the order of the Secretary General of Indian Road Congress making such an appointment shall be furnished to each of the parties.
- (c) Arbitration proceedings shall be held at New Delhi, India, and the language of the arbitration proceedings and that of all documents and communications between the parties shall be English.

- (d) The decision of the majority of arbitrators shall be final and binding upon both parties.
- (e) The cost and expenses of Arbitration proceedings will be borne equally by both parties in accordance with the following fee structure (the signing of the contract shall be the acceptance of the fee structure given below by both the parties):

<b>S.No.</b>	<b>Particulars of fee and other charges</b>	<b>Schedule Amount payable per Arbitrator/ per case</b>
1.	Arbitrator fee	Rs.15,000/- per day subject to a maximum of Rs.4.0 lacs per case; or Rs.2.5 lacs (lump sum) subject to publishing the Award within 12 months. 12 months will be reckoned from the date of first meeting.
2.	Reading Charges	Rs.15,000/-
3.	Secretarial Assistance and Incidental Charges (telephone, fax, postage etc.)	Rs.20,000/-
4.	Charges for Publishing/ declaration of the Award	Maximum of Rs.20,000/-
5.	Other expenses (As per actual against bills subject to maximum of the prescribed ceiling given below)	
	Traveling Expenses	Economy class by air, first class AC by train, AC car by road
	Lodging and Boarding	(i) Up to Rs.15,000/- per day (metro cities) (ii) Up to Rs.7,000/- per day (other cities) (iii) Rs.3,000/- per day (own arrangement)
6.	Local Travel	Rs.1,500/- per day
7.	Extra charges for days other than hearing / meeting days (maximum for 2 days)	Rs.3,500/- per day
Note:-	1. Lodging, boarding and traveling expenses shall be allowed only for those members who are residing 100 kms. away from place of meeting	
	2. Delhi, Mumbai, Chennai, Kolkata, Bangalore and Hyderabad shall be considered as Metro Cities.	

However, the expenses incurred by each party in connection with the preparation, presentation, etc. of its proceedings shall be borne by each party itself.

- (f) Performance under the contract shall continue during the arbitration proceedings and payments due to the contractor by the employer shall not be withheld, unless they are the subject matter of the arbitration proceedings.

## 26. DELETED

## **B. Time Control**

### **27. Programme**

- 27.1** The Engineer shall issue the indent of work in stages specifying the time limit for the same as and when required. The Contractor shall submit to the Engineer for approval a programme within the time stipulated in the Contract Data showing the general methods, arrangements, order, and timing for all the activities in the Works, along with monthly cash flow forecasts.
- 27.2** An update of the Programme shall be a programme showing the actual progress achieved on each activity and the effect of the progress achieved on the timing of the remaining Works, including any changes to the sequence of the activities.
- 27.3** The Contractor shall submit to the Engineer for approval an updated Programme at intervals. If the Contractor does not submit an updated Programme within this period, the Engineer may withhold the amount stated in the Contract Data from the next payment certificate and continue to withhold this amount until the next payment after the date on which the overdue Programme has been submitted.
- 27.4** The Engineer's approval of the Programme shall not alter the Contractor's obligations. The Contractor may revise the Programme and submit it to the Engineer again at any time. A revised Programme shall show the effect of Variations and Compensation Events.

### **28. Extension of the Intended Completion Date**

- 28.1** The Engineer shall extend the Intended Completion Date only after the approval of NHIDCL if a Compensation Event occurs or a Variation is issued which makes it impossible for Completion to be achieved by the Intended Completion Date without the Contractor taking steps to accelerate the remaining Works, which would cause the Contractor to incur additional cost.
- 28.2** The Engineer shall decide whether and by how much time to extend the Intended Completion Date within 21 days of the Contractor asking the Engineer for a decision upon the effect of a Compensation Event or Variation and submitting full supporting information. If the Contractor has failed to cooperate in dealing with a delay, the delay by this failure shall not be considered in assessing the new Indented Completion Date.

### **29. Delays Ordered by the Engineer**

- 29.1** Deleted.

### **30. Management Meetings**

- 30.1** The Engineer may require the Contractor to attend a management meeting. The business of a management meeting shall be to review the plans for the Works.
- 30.2** The Engineer shall record the business of management meetings and provide copies of the record to those attending the meeting. The responsibility of the parties for actions to be taken shall be decided by the Engineer either at the management meeting or after the management meeting and stated in writing to all those who attended the meeting.

## **C. Quality Control**

### **31. Identifying Defects**

**31.1** The Engineer shall check the Contractor's work and notify the Contractor of any Defects that are found. Such checking shall not affect the Contractor's responsibilities. The Engineer may instruct the Contractor to search for a Defect and to uncover and test any work that the Engineer considers may have a Defect.

### **32. Tests**

**32.1 Deleted**

### **33. Correction of Defects noticed during the Defect Liability Period.**

**33.1 Deleted**

### **34. Uncorrected Defects**

**34.1 Deleted**

## **D. Cost Control**

### **35. Bill of Quantities**

**35.1** The Bill of Quantities shall contain items for the construction, installation, testing, and commissioning and maintaining works to be done by the Contractor.

**35.2** The Bill of Quantities is used to calculate the Contract Price. The Contractor is paid for the quantity of the work done at the rates in the Bill of Quantities for each item for the work executed.

**35.3 Changes in the Quantities:** The proposed quantity in the RFP/ estimate may be increase or decrease based on the requirement as per the direction of Site Engineer and the quote rate shall be applicable for any changes. As per work order, the bidder shall deploy the quantity of vehicle etc. on the site.

## **36. Variations**

**36.1 All variations shall be included in updated programmes produced by the Contractor.**

## **37. Payments for Variations**

**37.1** If rates for Variation items are specified in the Bill of Quantities, the Contractor shall carry out such work at the same rate.

**37.2** If the rates for Variation are not specified in the Bill of Quantities, the Engineer shall derive the rate from similar items in the Bill of Quantities and if it cannot be derived from similar item in Bill of Quantities then the rate will be derived as per Clause 37.3.

**37.3** The Contractor shall, within 14 days of the issue of order of Variation work, inform the Engineer the rate which he proposes to claim, supported by analysis of the rates. The Engineer shall assess the quotation and determine the rate based on prevailing market rates within one month of the submission of the claim by the Contractor and approval from NHIDCL will be taken. As far as possible, the rate analysis shall be based on the standard data book and the current schedule of rates of the district public works division.

## **38. Cash Flow Forecasts**

**38.1** When the Programme is updated, the Contractor shall provide the Engineer with an updated cash flow forecast.

## **39. Payment Certificates**

**39.1** The Contractor shall submit to the Engineer monthly statements of the value of the work executed less the cumulative amount certified previously supported with detailed measurement of the items of work executed.

**39.2** The Engineer shall check the Contractor's monthly statement within 14 days and certify the amount to be paid to the Contractor after taking into account any credit or debit for the month in question.

**39.3** The value of work executed shall be determined, based on measurements by the Engineer.

**39.4** The value of work executed shall comprise the value of the quantities of the items in the Bill of Quantities completed.

**39.5** Deleted.

**39.6** The Engineer / Employer may exclude any item certified in a previous certificate or reduce the proportion of any item previously certified in any certificate in the light of later information.

**39.7** The final bill shall be submitted by the contractor within one month of the actual date of completion of the work; otherwise the Engineers certificate of the measurement and of the total amount payable for work accordingly shall be final and payment made accordingly within a period of sixty days as far as possible.

#### **40. Payments**

**40.1** Payments shall be adjusted for deductions for advance payments, security deposit, other recoveries in terms of the Contract and taxes at source, as applicable under the law. The Employer shall pay the Contractor the amounts Engineer had certified within 10 days of the date of each certificate.

**40.2** The Authorized Representative of the Employer shall make the payment certified by the Engineer.

**40.3** Items of the Works for which no rate or price has been entered in the Bill of Quantities, will not be paid for by the Employer and shall be deemed to be covered by other rates and prices in the Contract.

#### **41. DELETED**

#### **42. Taxes & Currencies for payments**

**42.1** The rates quoted by the Contractor shall be deemed to be inclusive of the sales and other levies, duties, royalties, cess, toll, taxes of Central and State Governments, local bodies and authorities that the Contractor will have to pay for the performance of this Contract. The Employer will perform such duties in regard to the deduction of such taxes at source as per applicable law. The GST shall be reimbursed (if applicable) subject to production of proof of such payment by the contractor (proof should contain name of work).

**42.2** All payments will be made in Indian Rupees.

#### **43. Price Adjustment- Deleted**

#### **44. Security Deposit / Retention Money**

**44.1** The Employer shall retain security deposit of five percent of the amount from each payment due to the Contractor until Completion of the whole of the Works.

**44.2** The security deposit/retention money and the performance security will be released to the Contractor when the Defect Liability period is over, and the Engineer has certified that the Defects, if any, notified by the Engineer to the Contractor before the end of this period have been corrected.

**44.3** If the contractor so desires then the Security Deposit/retention money can be released on submission of unconditional Bank Guarantee at the following two stages:-

- (a) At a point after the progress of work in financial term (gross value of work done) has reached 50% of the contract amount
- (b) After the retention money has been deducted to the full value (5% of the Contract Amount).

## **45. Liquidated Damages**

- 45.1** The Contractor shall pay liquidated damages to the Employer at the rate or part thereof stated in the Contract Data for each day that the Completion Date is later than the Intended Completion Date. The total amount of liquidated damages shall not exceed the amount defined in the Contract Data. The Employer may deduct liquidated damages from payments due to the Contractor. Payment of liquidated damages shall not affect the Contractor's other liabilities.
- 45.2** If the Intended Completion Date is extended after liquidated damages have been paid, the Engineer shall correct any overpayment of liquidated damages by the Contractor by adjusting in the next payment certificate. The contractor shall not be paid interest on the over payment of liquidated damages.

## **46. Advance Payment**

- 46.1** DELETED.

## **47. Securities**

- 47.1** Subject to further condition in contract data, the Performance Security equal to ten percent of the contract price and additional security for unbalanced bids shall be provided to the Employer no later than the date specified in the Letter of Acceptance and shall be issued in the form given in the Contract Data and by a prescribed bank. The Performance Security shall be valid until a date 28 days after the expiry of work and the additional performance security for unbalanced bids shall be valid until a date 28 days from the date of issue of the certificate of completion. The validity shall account for additional 3 months time to account for BG verification, signing of contract and start date

## **48. Cost of Repairs**

- 48.1** Loss or damage to the Works or Materials to be incorporated in the Works between the Start Date and the end of the Defects Liability Period shall be remedied/ rectified by the Contractor at their cost if the loss or damage arises from the Contractor's acts or omissions.

## **E. Finishing the Contract**

### **49. Completion**

- 49.1** The Contractor shall request the Engineer to issue a certificate of Completion of the Works, and the Engineer will do so upon deciding that the Works is completed.

### **50. Taking Over**

- 50.1** The Employer shall take over the Site and the Works within seven days of the Engineer's issuing a certificate of Completion.

### **51. Final Account**

- 51.1** The Contractor shall supply to the Engineer with a detailed account of the total amount that the Contractor considers payable under the Contract before the end of the Defects Liability

Period. The Engineer shall issue a Defects Liability Certificate and certify any final payment that is due to the Contractor within 56 days of receiving the Contractor's account if it is correct and complete. If it is not, the Engineer shall issue within 56 days a schedule that states the scope of the corrections or additions that are necessary. If the Final Account is still unsatisfactory after it has been resubmitted, the Engineer shall decide on the amount payable to the Contractor and issue a payment certificate within 56 days of receiving the Contractor's revised account.

## **52. Operating and Maintenance Manual**

### **52.1 DELETED**

## **53. Termination/ Foreclosure**

**53.1** The Employer may terminate the Contract if the Contractor causes a fundamental breach of the Contract.

**53.2** Fundamental breaches of Contract include, but shall not be limited to, the following:

- a) the Contractor stops work for 28 days when no stoppage of work is shown on the current Programme and the stoppage has not been authorized by the Engineer;
- b) the Contractor is declared as bankrupt or goes into liquidation other than for approved reconstitution or amalgamation;
- c) the Engineer/Employer gives Notice that failure to correct a particular Defect is a fundamental breach of Contract and the Contractor fails to correct it within a reasonable period of time determined by the Engineer;
- d) the Contractor does not maintain a Security, which is required;
- e) the Contractor has delayed the completion of the Works by the number of days for which the maximum amount of liquidated damages can be paid, as defined in clause 45;
- f) the Contractor fails to provide insurance cover as required under clause 13;
- g) if the Contractor, in the judgement of the Employer, has engaged in the corrupt or fraudulent practice in competing for or in executing the Contract. For the purpose of this clause, "corrupt practise" means offering, giving, receiving, or soliciting of any thing of value to influence the action of a public official in the procurement process or in Contract execution. "Fraudulent Practice" means a misrepresentation of facts in order to influence a procurement process or the execution of a contract to the detriment of the Employer and includes collusive practice among Bidders (prior to or after bid submission) designed to establish bid process at artificial non-competitive levels and to deprive the Employer of the benefits of free and open competition.
- h) if the Contractor has not completed at least thirty percent of the value of Work required to be completed after half of the completion period has elapsed;
- i) if the Contractor fails to set up a field laboratory with the prescribed equipment, within the period specified; and
- j) any other fundamental breach as specified in the Contract Data.

**53.3** Without prejudice to any other right or remedies which the Employer may have under this contract, upon occurrence of a Contractor's fundamental breach of contract, the Employer shall be entitled to terminate this contract by issuing a Termination Notice to the Contractor ; provided that before issuing the Termination Notice, the Employer shall by a Notice inform the Contractor of its intention to issue such Termination Notice and grant 15 days to the Contractor to

make a representation, and may after the expiry of such 15 days, whether or not it is in receipt of such representation, issue the Termination Notice.

53.4 Notwithstanding the above, the Employer may terminate the Contract for convenience.

53.5 If the Contract is terminated, the Contractor shall stop work immediately, make the Site safe and secure, and leave the Site as soon as reasonably possible but in no case later than 7 days.

**53.6 Foreclosure-** NHIDCL may foreclose the contract before the expiry of the scheduled contract period on account of taking up the stretch for future development of highway or OMT of the highway or due to any reason by giving prior Notice.

## **54. Payment upon Termination**

**54.1** If the Contract is terminated because of a fundamental breach of Contract by the Contractor, the Engineer shall issue a certificate for the value of the work done and Materials ordered less advance payments received up to the date of the issue of the certificate and less the percentage to apply to the value of the work not completed, as indicated in the Contract Data. Additional Liquidated Damages shall not apply. If the total amount due to the Employer exceeds any payment due to the Contractor, the difference shall be a debt payable to the Employer.

**54.2** Save and except Cl 35.3.3, if the Contract is terminated at the Employer's convenience, the Engineer shall issue a certificate for the value of the work done, the reasonable cost of removal of Equipment, repatriation of the Contractor's personnel employed solely on the Works, and the Contractor's costs of protecting and securing the Works and less advance payments outstanding on the date of the certificate, less other recoveries due in terms of the Contract, and less taxes due to be deducted at source as per applicable law.

In case of termination on account of award of 6 laning or OMT work stated in Cl 35.3.3, the Engineer shall issue a certificate for the value of work done till termination, less advance payments outstanding, less other recoveries due in terms of contract and less taxes due to be deducted at source as per applicable law.

## **55. Property**

**55.1** All Materials on the Site, Plant, Equipment, Temporary Works, and Works shall be deemed to be the property of the Employer for use for completing balance work if the Contract is terminated because of the Contractor's default.

## **56. Release from Performance**

**56.1** If the Contract is frustrated by the outbreak of war or by any other event entirely outside the control of the Employer or the Contractor, the Engineer shall certify that the Contract has been frustrated. The Contractor shall make the Site safe and stop work as quickly as possible after receiving this certificate and shall be paid for all work carried out before receiving it and for any work carried out afterwards to which a commitment was made.

## **F. Other Conditions of Contract**

### **57. Labour**

**57.1** The Contractor shall, make arrangements of his own cost and expenses for the engagement of all staff and labour, local or others; for their payment, housing, feeding and transport; and for compliance with various labour laws/ regulations.

**57.2** The Contractor shall, as asked by the Engineer, deliver to the Engineer a return in detail, in such form and at such intervals as the Engineer may prescribe, showing the staff and the numbers of the several classes of labour from time to time employed by the Contractor on the Site and such other information as the Engineer may require.

### **58. COMPLIANCE WITH LABOUR REGULATIONS**

**58.1** During the currency of the Contract, the Contractor and his sub Contractors shall abide at all times by all existing labour enactments and rules made thereunder, regulations, notifications and bye laws of the State or Central Government or local authority and any other labour law (including rules), regulations, bye laws that may be notified already or that may be notified under any labour law in future either by the State or the Central Government or the local authority. Salient features of some of the major labour laws that are applicable to construction industry are given below. The Contractor shall keep the Employer indemnified in case any action is taken against the Employer by the competent authority on account of contravention of any of the provisions of any Act or rules made thereunder, regulations or notifications including amendments. If the Employer is caused to pay or reimburse, such amounts as may be necessary to cause or observe, or for non-observance of the provisions stipulated in the notifications/bye laws/Acts/Rules/regulations including amendments, if any, on the part of the Contractor, the Engineer/Employer shall have the right to deduct any money due to the Contractor including from his performance security/ retention money. The Employer/Engineer shall also have right to recover from the Contractor any sum required or estimated to be required for making good the loss or damage suffered by the Employer. The employees of the Contractor and the Sub-Contractor in no case shall be treated as the employees of the Employer at any point of time.

### **58.2 SALIENT FEATURES OF SOME MAJOR LABOUR LAWS APPLICABLE TO ESTABLISHMENTS ENGAGED IN BUILDING AND OTHER CONSTRUCTION WORK.**

- a) **Workmen Compensation Act 1923:** - The Act provides for compensation in case of injury by accident arising out of and during the course of employment.
- b) **Payment of Gratuity Act 1972:** - Gratuity is payable to an employee under the Act on satisfaction of certain conditions on separation if an employee has completed the prescribed minimum years (say, five years) of service or more or on death the rate of prescribed minimum days' (say, 15 days) wages for every completed year of service. The Act is applicable to all establishments employing the prescribed minimum number (say, 10) or more employees.
- c) **Employees P.F. and Miscellaneous Provision Act 1952:** The Act Provides for monthly contributions by the Employer plus workers at the rate prescribed (say, 10% or 8.33%). The benefits payable under the Act are:
  - i. Pension or family pension on retirement or death as the case may be.

- ii. Deposit linked insurance on the death in harness of the worker.
  - iii. Payment of P.F. accumulation on retirement/death etc.
- d) **Maternity Benefit Act 1951:** - The Act provides for leave and some other benefits to women employees in case of confinement or miscarriage etc.
- e) **Contract Labour (Regulation & Abolition) Act 1970:** - The Act provides for certain welfare measures to be provided by the Contractor to contract labour and in case the Contractor fails to provide, the same are required to be provided, by the Principal Employer by Law. The principal Employer is required to take Certificate of Registration and the Contractor is required to take license from the designated Officer. The Act is applicable to the establishments or Contractor of Principal Employer if they employ prescribed minimum (say 20) or more contract labour.
- f) **Minimum Wages Act 1948:** - The Employer is to pay not less than the Minimum Wages fixed by appropriate Government as per provisions of the Act if the employment is a scheduled employment. Constructions of buildings, roads, runways are scheduled employment.
- g) **Payment of Wages Act 1936:** - It lays down as to by what date the wages are to be paid, when it will be paid and what deductions can be made from the wages of the workers.
- h) **Equal Remuneration Act 1979:** - The Act provides for payment of equal wages for work of equal nature to male and female workers and for not making discrimination against female employees in the matters of transfers, training and promotions etc.
- i) **Payment of Bonus Act 1965:** - The Act is applicable to all establishments employing prescribed minimum (say, 20) or more workmen. The Act provides for payments of annual bonus within the prescribed range of percentage of wages to employees drawing up to the prescribed amount of wages, calculated in the prescribed manner. The Act does not apply to certain establishments. The newly set-up establishments are exempted for five years in certain circumstances. States may have different number of employment size.
- j) **Industrial Disputes Act 1947:** - The Act lays down the machinery and procedure for resolution of industrial disputes, in what situations a strike or lock-out becomes illegal and what are the requirements for laying off or retrenching the employees or closing down the establishment.
- k) **Industrial Employment (Standing Orders) Act 1946:** - It is applicable to all establishments employing prescribed minimum (say, 100, or 50). The Act provides for laying down rules governing the conditions of employment by the Employer on matters provided in the Act and get these certified by the designated Authority.
- l) **Trade Unions Act 1926:** - The Act lays down the procedure for registration of trade unions of workmen and Employers. The Trade Unions registered under the Act have been given certain immunities from civil and criminal liabilities.

- m) **Child Labour (Prohibition & Regulation) Act 1986:** - The Act prohibits employment of children below 14 years of age in certain occupations and processes and provides for regulations of employment of children in all other occupations and processes. Employment of child labour is prohibited in building and construction industry.
  
- n) **Inter-State Migrant Workmen's (Regulation of Employment & Conditions of Service) Act 1979:** - The Act is applicable to an establishment which employs prescribed minimum (say, five) or more inter-state migrant workmen through an intermediary (who has recruited workmen in one state for employment in the establishment situated in another state). The Inter-State migrant workmen, in an establishment to which this Act becomes applicable, are required to be provided certain facilities such as Housing, Medical-Aid, Travelling expenses from home up to the establishment and back etc.
  
- o) **The Building and Other Construction workers (Regulation of Employment and Conditions of Service) Act 1996 and the Cess Act of 1996:** - All the establishments who carry on any building or other construction work and employs the prescribed minimum (say, 10) or more workers are covered under this Act. All such establishments are required to pay cess at the rate not exceeding 2% of the cost of construction as may be modified by the Government. The Employer of the establishment is required to provide safety measures at the building or construction work and other welfare measures, such as canteens, first-aid facilities, ambulance, housing accommodations for workers near the work place etc. The Employer to whom the Act applies has to obtain a registration certificate from the Registering Officer appointed by the Government.
  
- p) **Factories Act 1948:** - The Act lays down the procedure for approval of plans before setting up a factory, health and safety provisions, welfare provisions, working hours, annual earned leave and rendering information regarding accidents or dangerous occurrences to designated authorities. It is applicable to premises employing the prescribed minimum (say, 10) persons or more with aid of power or another prescribed minimum (say, 20) or more persons without the aid of power engaged in manufacturing process.

## **59. Drawings and Photographs of the Works**

- 59.1** The contractor shall do photography/videography of the site firstly before the start of the work and lastly after the completion of the work. No separate payment will be made to the contractor for this.
  
- 59.2** The Contractor shall not disclose details of Drawings furnished to him and works on which he is engaged without the prior approval of the Engineer in writing. No photograph of the works or any part thereof or plant employed thereon, except those permitted under clause 59.1, shall be taken or permitted to be taken by the Contractor or by any of his employees or any employees of his sub-Contractors without the prior approval of the Engineer in writing. No photographs/ Videography shall be published or otherwise circulated without the approval of the Engineer in writing.

**60. The Apprenticeship Act 1961**

**60.1** The Contractor shall duly comply with the provisions of the Apprenticeship Act 1961 (III of 1961), the rules made thereunder and the orders that may be issued from time to time under the said Act and the said Rules and on his failure or neglect to do so he shall be subject to all liabilities and penalties provided by the said Act and said Rules.

## CONTRACT DATA

Clause Reference

**Items marked “N/A” do not apply in this Contract.**

1. The Employer is [Cl.1.1]  
Managing Director, NHIDCL  
Address: 3<sup>rd</sup> Floor, PTI Building, Parliament Street, New Delhi  
Name of Authorized  
  
Representative : Executive Director, RO NHIDCL Agartala
2. The Engineer is: will be intimated later. [Cl.1.1]
3. The Intended Completion Date for the whole of the Works is 6 months or upto 31.03.2021, whichever is earlier, from Start Date. [Cl.1.1, 17&28]
4. The Site is all National Highways in the State of Tripura for which rescue Ambulance JCB, toeing Crane & Route Patrol is required. [Cl.1.1]
5. The Start Date shall be within 7 days after the date of issue of the Notice to proceed with the work [Cl.1.1]
6. (a) The name and identification number of the Contract  
“Providing of incident Management Services (Route Patrol, Crane, Ambulance & JCB) for National Highways in the State of Tripura.”  
[Cl.1.1]  
(b) **The Work consist of “providing of** incident management services viz. Route Patrol, Crane, JCB, Ambulance. [Cl.1.1]
- 3.1 (a) The law which applies to the Contract is the law of Union of India. [Cl.3.1]  
  
(b) The language of the Contract documents is English [Cl.3.1]

7.1 No sub contractors is allowed [Cl.7.1]

8.1 **Schedule of Other Contractor – NIL** [Cl 8.1]

9.1 The Technical Personnel are: [Cl.9.1]

Sl. No.	Personnel	Minimum Qualification and Experience	Particular Experience (minimum requirement)	No. of Persons
1.	Incident cum Road Property Manager cum Route Operation Manager	Graduate from a recognized University + 5 yrs. Exp.	3 years on highway property management and maintenance	2 (one for each IM Centre)

13.1. Amount for insurance are: [Cl.13.1]

- a) Rupees equivalent to Contract price.
  - b) Rupees equivalent to 5% of Contract price.
  - c) Rupees equivalent to 5% of contract price
  - d) Rupees 10 lakhs for multiple incidents.
- And deductible as per premium rate.

14.1 Site Investigation Report – NIL [Cl 14.1]

27.1. (A) The period for submission of the programme for approval of Engineer [Cl.27.1] shall be **3 days** from the issue of Letter of Commencement.

- (B). (a) Identified indented work
- (1) Weekly Indent – 2 days before start of week;
  - (2) Emergent Indents – Within 24 hours

**27.3** Amount to be withheld for delays in submission of updated programme : 1% of value of work corresponding to the updated programme. (Cl. 27.3)

<b>45.1</b> (a) Amount of liquidated damages for work delay in completion of works	For identified Indented 0.1 percent of the Indented value, rounded off to the nearest thousand, per day with the minimum of Rs. 10000/- per day
(b) Maximum limit of liquidated damages for the Initial delay in completion of work. rounded	10 per cent of Contract Price  off to the nearest thousand

[Cl.45.1]

**47.1.** The standard form of Performance Security acceptable to the Employer Shall be an unconditional Bank Guarantee of the type as specified in the Bidding Documents.

[Cl. 47.1]

**53.2 (j)** Other fundamental breach is that the contractor has failed to complete 75% of value of indented work in any 3 indents issued by the Engineer.

[Cl 53.2 (j)]

**54.1.** The percentage to apply to the value of work not completed representing the Employer's additional cost for completing the work shall be 20%.

[Cl.54.1]

---

**(SECTION-VI)**  
**SCOPE OF WORK**

## SCOPE OF WORK

### SCOPE OF WORK

#### 6.1 General-

- **Road property management** - Identification of encroachments and ribbon development, enforcement of regulations, Liaisoning with the relevant authorities for above including procurement of land records with ownership as per mutation from the concerned Revenue Authorities and help in mutation, if required etc.,
- **Incident management** - road patrols and surveillance, first aid, rescue ambulance, basic automobile assistance, tow away cranes, removal of obstruction materials onto the road by JCB, wireless/mobile facility and road safety works.
- **Inspections**- Full and complete inspection of the highway section including other highways properties such as shall be undertaken at appropriate intervals.

#### 6.2

DELETED

#### 6.3 Road property management

The Contractor shall ensure the maximum availability and efficient utilisation of the assets for the NHIDCL. This shall also include the protection of the right of way from encroachments and other unauthorised activities. For this purpose, the Contractor with the help of the Authority Representative and Revenue Authority shall maintain Land Record Register for entire NH ROW and shall also draw up a comprehensive asset register detailing the condition of the entire existing road and building assets. This asset register shall be maintained and continually updated after any additions to the infrastructure and after each of the required inspections.

Any damage or loss to asset of highway like signages, delineators, boards etc. by way of theft or due to negligence of the Contractor, shall be fully recoverable from the Contractor.

##### 6.3.1 Unauthorised Encroachments

The strict enforcement of the requirements of the NHIDCL shall be a significant obligation under the Contract. The NHIDCL shall define the Right of Way and their requirements with respect to un-authorized accesses, encroachments and the like.

The Contractor shall be required to detect report, use it's best endeavors and remove all unauthorized encroachments within the right of way as soon as possible. The Contractor shall be required to record all such encroachments and seek any assistance from Police, local authorities and the NHIDCL as it deems fit, in order to ensure that all such encroachments are removed.

At the start of the Contract, the Contractor shall be required to determine all encroachments and unauthorized accesses to the highway, existing at time being

granted access to site. The Contractor shall list out the encroachments with a description, location and extent of each encroachment, draw up a method statement and programme for the removal of the unauthorized accesses or encroachments for approval by the NHIDCL. All existing encroachments shall be removed, and unauthorized accesses closed within 1 months of the Contractor being granted access to site.

#### **6.4 Incident Management**

The Contractor shall set up and maintain an Incident Management System (IMS) and supply regular incident statistics to NHIDCL.

Incident Management entails a set of coordinated activities initiated by the Contractor when an incident (an extraordinary event resulting in the reduction of road capacity or creates a hazard for users) occurs, in order to minimize the effects of the incident and restore normal capacity and safety levels to all affected road facilities as efficiently as possible.

The Contractor has to identify relevant agencies (e.g. rescue, fire, hazardous materials, traffic, police, ambulance, hospitals, alternative routes, cleanups) and their representatives and to liaise with these representatives on behalf of the employer.

The incident management centre on the project highway (minimum 500 sqm.) shall be continuously staffed on a 24 hours basis. The Contractor shall maintain records of the details of all incidents (e.g. collision, hazardous material, breakdown, etc). After occurrence of any major incident, resulting in multiple loss of life, significant periods of road closure or major route rehabilitation work, an incident debriefing report shall be produced and forwarded to NHIDCL within 24 hours of occurrence. The Incident Management Centre shall monitor the location of route of incident management vehicles / Rescue operation vehicles through VTS on continuous basis.

Contractor will keep a record of the removed accidental/damaged vehicles by taking a dated photograph of the same and will submit the report on weekly basis to the Employer/Engineer.

Contractor will remove dead animals/birds from the carriageway and bury them at a suitable location as directed by the engineer/employer within two hours of the incident and accident vehicles/Debris within 4 hours. If contractor fails to remove the dead animals/birds from the carriageway within two hours of the incident, he will be levied a penalty of Rs. **10,000/-** per such incident.

### 6.4.1 Route Patrols

The Contractor is required to provide 24 hrs per day route patrols to assist the road users of the highway, to provide information, feedback and perform functions in relation to incident management. To achieve this, the Patrol vehicles fitted with VTS should be fully equipped as well as the patrol persons should be adequately trained in traffic management, road safety and primary first aid. Apart from driver, a patrol person should be graduate and fluent in local language. The purpose of these patrols is to:

- Provide the users of the highway with basic mechanical help for vehicles that breakdown on the road and also protect other users from such vehicles.
- Immediately identify traffic hazards of whatever nature, such as unauthorized parking, public transport vehicles, obstructing traffic during passenger loading and unloading, debris, stray animals and the like. The operator shall take the necessary measures to remove such obstructions.
- Provide emergency management at accident scenes until such time as the appropriate authorities arrive.
- Assist with the removal of damaged or mechanically impaired vehicles from the highway.
- Provide road user information and to further the image of National Highway Section.
- Maintain daily records of assistance provided to road users.
- Observe, record and report suspect aspects of the highway, hazards and incident damage caused by vehicles, floods, storms or other random events, such that the highway maintenance records and database are continuously improved.

### I Patrol Vehicles / Rescue Vehicles

Patrol Vehicle / Rescue Vehicles deployed by the contractor shall conform to the specification / Norms prescribed by the NHAI as per Policy Circular No. NHAI /Policy Guidelines/ Strengthening the Incident Management Services/2018 Policy No. 12.19, dated 20<sup>th</sup> March 2018. (Copy Enclosed).

Number of Patrol Vehicle : 2 No.

1 Patrol vehicle	to be deployed in Shanti Bazaar on NH-08 Udaipur to Sabroom section	To make minimum 3 trips from Udaipur to Sabroom in a day and to cover about 6000 Kms in a calendar month of 30 days.
1 Patrol vehicle	to be deployed in Teliamura on Khowai-Teliamura- Amarpur section <b>And/or</b> Champaknagar-Teliamura-Ambassa Section	To make minimum 3 trips from Khowai-Teliamura- Amarpur or 4 trips of Champaknagar-Teliamura-Ambassa Section in a day and to cover about 6000 Kms in a calendar month of 30 days.

## II Ambulance

Ambulance deployed by the contractor shall confirm to the specification / Norms prescribed by the NHAI as per Policy Circular No. NHAI/Policy Guidelines/Strengthening the Incident Management Services/2018 Policy No. 12.19, dated 20<sup>th</sup> March" 2018.

Number of Ambulance : 2 No.

1 Ambulance	to be deployed in Shantibazaar on NH-08 for Udaipur to Sabroom section	May make 3 or 4 trips in a day and report any incident to the nearest RO/PMU/SO, NHIDCL.
1 Ambulance	to be deployed in Manu on NH-08 for Kumarghat to Ambassa section	May make 3 or 4 trips in a day and report any incident to the nearest RO/PMU/SO, NHIDCL.

## III JCB

JCB deployed by the contractor for section of NH as per requirement of GM PMU Teliamura or DGM PMU Kumarghat. The mahcinery will be utilized only for emergency works after instruction from the Site Engineer of NHIDCL.

- a) Driver, with knowledge of vehicle repair and fluent in local language
- b) A helper

Number of JCB : 2 No. are required for the State of Tripura ( to be deployed as per instruction of NHIDCL)

## IV Tow Away Vehicle (crane)

The vehicle fitted with VTS shall be in good condition and registration number not older than 2 years. The vehicle shall be painted with approved colour pattern with NHIDCL name & LOGO and emblem painted sides, back and front. The Contractor must employ following manpower to work in shifts:

- c) Driver, with knowledge of vehicle repair and fluent in local language
- d) A helper

Number of Tow Away Vehicles : 2 No. (20 T Capacity) and it shall run minimum 5 km. daily (even for dry run) to be eligible for monthly payment.

1 Tow Away Vehicle (crane)	to be deployed in Shanti Bazaar on NH-08 Udaipur to Sabroom section	May make 3 or 4 trips in a day and report any incident to the nearest RO/PMU/SO, NHIDCL.
1 Tow Away Vehicle (crane)	to be deployed in Teliamura on Khowai-Teliamura- Amarpur section <b>And/or</b> Champaknagar-Teliamura-Ambassa Section	May make 3 or 4 trips in a day and report any incident to the nearest RO/PMU/SO, NHIDCL.

**Note :**

- i) In case of absence/deficiencies in respect of vehicles / manpower / equipment as mentioned under Clause 6.4 found during inspection by Engineer/Authority Representative a penalty of Rs. 5000/- per item per incidence shall be levied.
- ii) Incident Management Vehicles may be discontinued during the period of contract by the Employer. The agency will not have any claim due to demobilization of these vehicles at any stage.

**6.5 DELETED**

**6.6 Inspection**

Full and complete inspection of the highway section shall be undertaken at appropriate intervals as mentioned in this section and report the condition to the nearest RO/PMU/SO, NHIDCL.

**6.6.1 Daily followed by weekly and monthly inspection**

Items to be inspected daily on regular basis followed by weekly and monthly inspection shall include:

- Tow Away Trucks, Cranes etc.
- Frequency of Highway Patrol
- Accidents/Incidence/Road Block by land slide/ tree etc.
- Condition of Highway/ property of highway
- Encroachment,
- Black Spot,
- Junctions,
- Traffic control
- Ensuring clearly of signs and reducing traffic congestion
- Road side plantation

**6.8 PERFORMANCE STANDARDS**

**6.8.1 PERFORMANCE STANDARDS FOR MAINTENANCE:**

The performance standards define the level at which the proposed facility is to be maintained and operated.

Road Maintenance: (As per MOST Specifications)

A) Route operations

SL. NO	SERVICEABILITY INDICATOR	REQUIRED MAINTENANCE LEVEL	FREQUENCY OF INSPECTIONS BY CONTRACTOR TO ENSURE REQUIRED LEVEL OF SERVICE
1.	Tow away trucks, cranes	To reach the incident spot within 30 minute of incident occurrence	Daily on regular basis (24X7)
2.	Rescue Ambulance	To reach the incident spot within 30 minutes of incident occurrence.	Daily on regular basis (24X7)
3.	Frequency of highway patrol	3 or 4 trips in a day (a trip shall be of 4 hours on entire stretch (logging system))	Daily on regular basis (24X7)
4.	JCB	Utilized only for emergency work as per the requirement of site Engineers	Daily on regular basis (24X7)

6.8.2

DELETED

6.8.3 Performance Standards for Operations

- Set up of Control Room/ Incident Management Centre in **Shanti Bazar & Teliamura** with Staff for - 24 hrs/day
- Response time to a single incident - ½ an hour after receiving notification
- Multiple incidents - as soon as possible
- Report any incident or accident.
- Coordinate with local/ district administration and police authorities for evacuation of casualties, vehicles etc.
- Report to RO/ PMU any unauthorized occupation on the NH land entrusted to NHIDCL.
- The facility shall be kept clear of all obstructions to traffic. Broken down vehicles, accident remnants, fallen trees, or any other obstructions should be cleared at once, after completing any legal formalities. The availability of Tow-trucks, cranes, and other equipment required for this purpose shall be ensured.
- Accident relief measures, including an ambulance, shall be available round the clock. The response time should be 30 minutes. Traffic regulation and management to

minimise the disturbance due to accident to other traffic shall be taken by providing temporary traffic signs, cones, reflective tape etc.

- The JCB will be utilized only for emergency works to clear of all obstruction material onto the Highway/ road. The shall be available round the clock. The response time should be 30 minutes.
- The intersections at either end or in-between shall be managed such that delays to through traffic are minimised.
- Regular patrolling shall be done to ensure smooth traffic movement on the facility. The frequency of the patrol shall be at least once in 4 hours for the entire length of facility.
- In respect of route operation like patrol vehicle, ambulance and towing of vehicle, any case of non compliance as per Cl 6.8 of "Performance Standard", a penalty of Rs. 10,000/ for each non compliance incident will be levied.
- The log books for Route Patrol Vehicle, Ambulance and Crane shall be maintained as per "Logging System". i.e. exact time reached at particular incident and time at which the spot of incidence left out. Both vehicles should not waste time unnecessarily. From the entries of log book, if it is found that time is exhausted unnecessarily / arbitrarily, reduction in the rate of concerned BOQ item shall be made. Engineer's decision in this regard shall be final.
- Signed muster rolls of staff pertaining to route patrols and Ambulances shall be maintained. Any absenteeism of route patrol staff shall attract a penalty as per Clause 6.4. The decision of Engineer shall be final in this context.
- The Route Patrol Vehicle, Ambulance, JCB and Crane shall be equipped (for 24 x 7 period and total duration of contract) with Vehicle Trafficking System, equipment / medicines as mentioned in Cl.no.6.4 of "Incident Management". Any shortage of equipment / medicines shall attract penalty as per Clause 6.4. The decision of Engineer shall be binding on the contractor.
- The contractor shall submit following documents along with each monthly statement of work done.
  - a) The photographs (hard copies) of each incidence of damaged towed vehicle with use of crane for entire month.
  - b) The undertaking of route patrol In-charge and driver of each damaged towed vehicle stating that "no charges" i.e. the services of crane made freely available to damaged vehicle.

**The claim for BOQ item, "use of crane" shall not be entitled in absence of above mentioned data. Reduction in rate on pro-rata basis shall be proposed in absence of above data.**

- c) The contractor shall submit the following documents along with each monthly statements of work done.
  - i) The reports as per IRC 53 - 1973 and formats approved by Engineer of accidents occurred during the month.

- ii) The Photographs in hard and soft copies of all accidents and in soft copies for all other incidents.
- iii) The reports of incidents other than accidents shall be submitted in the format approved by Engineer.
- iv) **The contractor shall submit hard copies of VTS of all vehicles generated reports such as transit, / stoppage / Idle, average speed etc. for entire month along with each monthly bill.**

The photographs (hard copies) supplied shall be submitted by the contractor after rescue of incident and also along with invoice of incident works.

- The contractor shall submit the daily report of accidents / incidents occurred on each of next day. Failure of which shall attract penalty of Rs.500/ incidence.
- Each route patrol vehicle, ambulance, JCB and crane vehicle shall be installed with precise Vehicle Tracking System (VTS) of reputed ISO 9001 company. The VTS shall be based on Global Positioning System (GPS) and GSM / GPRS technology. The system shall also include micro, live, real time tracking web based software by use of which GIS maps shall be accessed and transit / stoppage / idle / over speed reports of vehicles shall be generated.
- **The payment to incident management vehicle will be made based on the report of vehicle tracking system and photographs of incident rescue. The payment may be proportionately deducted in case route operations has not been carried out as per Clause 6.8.1 (B) of Scope of Work.**
- For operation of this system one computer of brand approved by the Engineer alongwith internet facility shall be installed at "Control Room, by the contractor.
- The contractor shall install one broad band internet connection. He shall also make necessary arrangements for uninterrupted electricity supply to Control Room.
- The contractor shall bear all expenditure involved in purchasing VTS, software's, one computer and internet connection, maintenance and operation charges (for total period of contract) inclusive of all taxes as applicable.
- The contractor shall be responsible for 24 x 7 working of VTS. The necessary liaison with Producer Company is sole responsibility of contractor.
- The Control Room shall be manned by a Manager 24x7 to have proper monitoring on the route operation vehicles. The Control Room shall have record of the VTS of all the vehicles, photographs of the route operations of the previous day, as mentioned above, muster roll of the staff, previous day's report of incidence, accidents details duly filled in as per format as specified above and other reports related to route operations as defined by Engineer-in-charge.

## 6.9 DELETED

**6.10 DELETED**

**6.11**  
DELETED

**6.12 DELETED**

**6.13 Monitoring**

6.13.1 The Contractor shall submit the daily report (by email) indicating the day's activities and the work executed at site. The Contractor shall also inform any changes observed at site such as road condition, structure damages/changes, damages to road-signs, crash barriers, railing, encroachments and any other unusual changes at site before 11.00 AM everyday for the preceding 24 hours.

6.13.2 The daily report should be submitted to GM/DGM PMU and Engineer on daily basis as per proforma approved by Engineer in consultation with ED, RO, NHIDCL.

6.13.3 The detail summary of these daily inspections and work carried out shall form part of monthly bill in the form of email extracts otherwise payment may not be admissible.

**(SECTION-VII)**

**TECHNICAL SPECIFICATIONS**

## **TECHNICAL SPECIFICATIONS**

### **7.1 PREAMBLE:**

The Technical Specifications contained herein shall be read in conjunction with the other Bidding Documents as specified.

### **7.2 GENERAL REQUIREMENTS**

The Technical Specifications in accordance with which the entire work described hereinafter shall be executed and completed by the Contractor shall comprise of the following:

#### **7.2.1 PART – I – GENERAL TECHNICAL SPECIFICATIONS**

The General Technical Specifications shall be the “SPECIFICATIONS FOR ROAD AND BRIDGE WORKS” (FIFTH REVISION, 2013) issued by

the Ministry of Road Transport & Highways, Government of India and published by the Indian Roads Congress, hereinafter referred to as MORT&H Specifications.

#### **PART – II – SUPPLEMENTARY TECHNICAL SPECIFICATIONS**

When an Amended/Modified/Added Clause supersedes a Clause or part thereof in the said Specifications, then any reference to the superseded clause shall be deemed to refer to the Amended/Modified/Added Clause or part thereof.

In so far Amended/Modified/Added Clause may come in conflict or be inconsistent with any of the provisions of the MOST Specifications under reference, the

Amended/Modified/Added clause and the additional specifications shall always prevail.

**7.2.2** In the absence of any definite provisions on any particular issue in the aforesaid Specifications, reference may be made to the latest codes and specifications of IRC and BIS in that order, Where even these are silent, the construction and completion of the works shall conform to sound engineering practice as approved by the Engineer and, in case of any dispute arising out of the interpretation of the above, the decision of the Engineer shall be final and binding on the Contractor.

**7.2.3** The Authority/Client shall get the 3<sup>rd</sup> party quality audit of Bituminous work from any nearest reputed government technical institute for its gradation, bitumen content and thickness for every km. and construction agency shall bear the cost of these tests.



## **BILL OF QUANTITIES**

The Appendix forms part of Bid. Bidders are required to fill up all the blanks in the form of Bid and Appendix thereto)

### FINANCIAL BID FORM

To

The Executive Director,  
National Highways & Infrastructure Development Corporation Ltd.  
Regional Office,  
3rd Floor, UD Bhawan, Near Ravindra Bhawan  
Sakuntala Road, Agartala, Tripura-799001  
Email : [edp-agartala@nhidcl.com](mailto:edp-agartala@nhidcl.com),

#### DESCRIPTION OF WORKS:

Dear Sir,

Having examined the site of works and Bid Documents, comprising Instructions to Bidders, Scope of works, Conditions of Contract, Technical Specifications, Bill of Quantities and schedules for the execution of the above named works, we, the undersigned offer to execute and complete such works and remedy any defects therein in conformity with the said bid documents for the sum of Rs. \_\_\_\_\_ (Rupees \_\_\_\_\_) or such other sum as may be ascertained in accordance with the said Bid documents.

2. We undertake, if our Bid is accepted, to commence the work within Fifteen (15) days of receipt of the order to commence, and to complete and deliver the sections and whole of the works comprised in the Contract within the period stated in the bid hereto.
3. If our Bid is accepted, we will furnish Performance Security (ies) in the form of a Bank Guarantee to be jointly and severally bound on us, in accordance with the Conditions of Contract.
4. We agree to abide by this Bid for the period of One Hundred & Twenty (120) days from the last date fixed for Bid Submission and it shall remain binding upon us and may be accepted at any time before the expiry of that period.
5. We confirm our agreement to treat the Bid documents and other records connected with the works as secret and confidential documents and shall not communicate information contained therein to any person other than the person authorised by the Employer or use such information in any manner prejudicial to the safety and integrity of the works.
6. Unless and until an agreement is prepared and executed, this Bid, together with your written acceptance thereof, shall constitute a binding Contract between us, but without

prejudice to your right to withdraw such acceptance without assigning any reasons thereof.

We understand that you are not bound to accept the lowest or any bid you may receive.

Dated this \_\_\_\_\_ day of \_\_\_\_\_ 2020

Signature \_\_\_\_\_ in the capacity of \_\_\_\_\_ duly authorised

To sign Bid for and on behalf of \_\_\_\_\_  
(In block capital letters)

Address : \_\_\_\_\_  
\_\_\_\_\_

## Bill of Quantities

### 9.00 Preamble

- 9.01 The Bill of quantities shall be read in conjunction with the Instructions to Bidders, Conditions of Contract, Scope of Work and Specifications.
- 9.02 The quantities given in the Bill of quantities are estimated quantities. The basis of payment will be actual quantities of work indented and carried out and valued at the rates and prices tendered in the priced Bills of quantities, where applicable and otherwise at such rates and prices as the Engineer may fix with in the terms of Contract.
- 9.03 The rates and prices tendered in the priced Bill of Quantities shall include all equipment, plant, tools, spares, labour, supervision, overheads, consumables, materials, erection, maintenance, testing of input material delivered, profit, taxes and duties together with all general risks, liabilities and obligations set out and implied in the Contract and other incidentals to comply with the requirements of technical specifications and scope of work.
- 9.04 The rates and prices shall be quoted entirely in Indian Currency.
- 9.05 A rate or price shall be entered against each item in the Bill of Quantities whether the quantities are stated or not. The cost of the items against which the contractor has failed to enter rate or price shall be deemed to be covered by other rates and prices entered for the related items of work.
- 9.06 The whole cost of complying with the provisions of the contract shall be included in the items provided in the priced Bill of Quantities and where no rates are provided the cost shall be deemed to be distributed among the rates and prices entered for the related items of work.
- 9.07 The contractor shall keep the entire carriageway neat and clean throughout the contract period. The contractor shall maintain guard rails, railings, crash barriers, road furniture etc. in good condition by cleaning them frequently as advised / required by using suitable detergents/chemicals.
- The staff of the contractor shall wear safety jackets, shoes, helmets etc. while on duty and any violation will attract a fine of Rs. 5,000/- for each incident.
  - Failure to erect safety signage or trying to carry out the works without proper precautions/safety measures as required will attract a fine of Rs. 5,000/- for each incident.
- 9.08 General directions and descriptions of work and materials are not necessarily repeated or summarized in the Bill of Quantities. Reference to the relevant sections of the bidding document shall be made before entering rates or prices against each item in the Bill of Quantities.
- 9.09 Applicable GST will be paid as per actuals based on the Challans paid.

<b>Name of Work: Providing of Incident Management Services (Route Patrol, Crane, JCB &amp; Ambulance) for National Highways in the State of Tripura.</b>					
<b>INCIDENT MANAGEMENT</b>					
<b>Period: 6 months or upto 31.03.2021, whichever is earlier.</b>					
<b>Name of the Bidder:</b>					
<b>Estimated Cost excluding GST at (in Rs.)</b>				<b>73.51 Lakhs</b>	
<b>Financial Quote by the Bidder excluding GST (in Rs.)</b>					
<b>Price Schedule</b>					
Item No. (A)	Description of Items (B)	Unit (C)	Quantity (D)	Rate per months (excl. GST) (E)	Amount in Rs (excl. GST) (Cx Dx ExF)
1	Removing all types of broken down/vehicles which have met with accidents from the carriageway and toeing the same to proper locations i.e. nearest Police stations or some suitable location by using 20 tonne or of more capacity pick and carry crane, as per clause 6.4 of Scope of Work and as per Clause 6.8 'Performance Standard' of scope of work (including VTS /GPS Devices) and as per the new NHAI policy 12.19 dated 20 March 2018. (inclusive of all expenses such as manpower, office, stationary. Misc. etc)	2	6		<b>0.00</b>
2	Providing, running and maintaining route patrol vehicle as per clause 6.4 of Scope of Work and as per Clause 6.8 'Performance Standard' of scope of work (including VTS /GPS Devices) and as per the new NHAI policy 12.19 dated 20 March 2018. It also includes removal of dead animals lying on highways and burying them at proper safe location out of ROW. It will be incidental to this work. Payment will be made as defined in Clause 6.8 of Scope of Work. (inclusive of all expenses such as manpower, office, stationary. Misc. etc)	2	6		<b>0.00</b>
3	Provision of rescue Ambulance including paramedical staff, medicine, medical equipment which shall be available 24 X 7 on the road and to reach the incident spot within 30 minutes of incident occurrence and transport the patient to the nearby Hospital, as per clause 6.4 of Scope of Work and as per Clause 6.8 'Performance Standard' of scope of work (including VTS/ GPS Devices) and as per the new NHAI policy 12.19 dated 20 March 2018. (inclusive of all expenses such as manpower, office, stationary. Misc. etc)	2	6		<b>0.00</b>
4	Removing of any type of obstructions material onto the Road by JCB as soon as possible and dumped the material at nearby unused land, as per clause 6.4 of Scope of Work and as per Clause 6.8 'Performance Standard' of scope of work (including VTS/ GPS Devices). (inclusive of all expenses such as manpower, office, stationary. Misc. etc)	2	6		<b>0.00</b>
<b>TOTAL AMOUNT</b>					<b>0.00</b>

**As per NHA Policy Guidelines No.12.19 dated 20.03.2018, The Strengthening the Incident Management Services are as per attached Annexure-1**



# भारतीय राष्ट्रीय राजमार्ग प्राधिकरण

(सड़क परिवहन और राजमार्ग मंत्रालय)

## National Highways Authority of India

(Ministry of Road Transport and Highways)

जी-5 एवं 6, सेक्टर-10, द्वारका, नई दिल्ली-110075

G-5 & 6, Sector-10, Dwarka, New Delhi-110075

दूरभाष / Phone : 91-11-25074100/25074200

फैक्स / Fax : 91-11-25093507 / 25093514

**NHA/Policy Guidelines/ Strengthening the Incident Management services/2018**  
**Policy No.12.19, Dated the 20<sup>th</sup> March 2018**  
(Decision taken in 337<sup>th</sup> meeting of the Executive Committee under Agenda No.337.08  
& Chairman approval on 20.03.2018)

**Sub: Strengthening the Incident Management services being provided across existing concessions and on not covered stretches.**

NHA is constructing/ upgrading National Highways across the country on EPC/HAM/BOT mode from 2/ 4 lanes to 4/6 lanes and developing various expressways to facilitate for smooth and safe travel of road users. For efficient functioning of 4/6 lane National Highways, Operation & Maintenance activities are to be taken up simultaneously for safety of road users for which, Incident Management vehicles such as Ambulances, and Patrol vehicles duly fitted with GPS/ VTS system are to be deployed.

2. Currently, Incident Management services (ambulances and patrol vehicles) are provided primarily on completed highway stretches which are under BOT or OMT concessions, totalling to approximately 10,000 km.

3. It has been observed that there is a large variation in the quality of service and standards of ambulances and patrol vehicles currently deployed across various concessionaires / contractors, primarily because the concessions / contracts have been awarded at different points in time. Further, each highway concessionaire operates a local control room with an independent helpline number.

4. The proposal was discussed in the EC-337<sup>th</sup> meeting held on 05.03.2018 and the following decisions were taken :-

(a) The system in the existing concessions may be strengthened by ensuring uniformity of the standards for ambulances and patrol vehicles and

(b) Engaging such facilities at every 50 km in stretches where works is in progress. All these facilities shall be integrated with the helpline No. 1033. Hence, all incident related calls shall be directed to this helpline number, and shall be subsequently re-directed to the local control room of the respective concessionaire for incident management.

5. **Accordingly the following executive directions are issued:-**

(a) Uniform specifications along with new colour scheme of Ambulance and Patrol Vehicle duly approved by the competent authority are enclosed as **Annexure-I** for strict implementation.

(b) The existing Ambulances services and Patrol vehicles under BOT and OMT and other existing contracts needs to be upgraded and strengthened up to the above standards and specifications within next 3 months time. The strengthening of system will be done by respective concessioner/contractor with the guidance of ROs under change of scope. Last date of completion of upgradation/strengthening work is 30.06.2018.

4

(2)

(c) The similar facilities are to be provided @ 50 km on the other stretches of National Highways which are completed and are under maintenance of the construction agency by providing them a change of scope for which ROs are authorised.

(d) On the stretches of National Highways which are under construction/Under Implementation/widening and where, no such facility exist in the concession/contract agreement, similar facility will be provided by providing the Change of Scope to the construction agency for which ROs are authorised.

(e) For all other stretches, which are under Operation & Maintenance by O&M agencies and no such facility exist in their contract agreement. The similar facilities to be provided @ 50 km by the O&M Agency by providing them a change of scope for which RO are authorised.

(f) The new facility to be provided strictly as per the specifications and colour schemes given in **Annexure-I** by the ROs under OPEX or Service Model/Rent basis contract usually made for 2 years.

6. These facilities must be deployed and made operational on all the stretches as directed above by 30<sup>th</sup> June, 2018 without fail.

7. This is issued with the approval of the Competent Authority (Ref. EC Agenda 337.08)

Y  
20/03

(V.K. Sharma)

Chief General Manager (Coord.)

Encl: (Annexure-I) As above

To

1. All Officers at NHAI HQ/ROs/PIUs/CMUs/Site Offices
2. To PS of Chairman and all Members for information
3. For hosting on NHAI Website
4. Hindi Officer for translation in Hindi

## '2 patient capacity' Rescue Ambulance Specifications

Every '2 patient capacity' rescue ambulance should adhere to the minimum specifications as described below:

### Vehicle Characteristics

#### General Construction

- The road rescue ambulance shall comply with homologation requirements given in standards notified under CMVR 1989 and the AIS-125 Code. Wherever, there is difference in the homologation requirements given in other standards notified under CMVR 1989 and AIS-125 code, the requirements of AIS-125 code will be applicable.
- The rescue ambulance vehicle shall be a Swaraj Mazda/ Tempo traveler or equivalent which should be a new vehicle and should not have covered more than 2000 km at the time of procurement (from date of first registration)

#### Performance Requirements

- The road rescue ambulance loaded to the permissible gross vehicle weight shall be able to accelerate from 0 km/h to 70 km/h within 40s, when tested in accordance with IS: 11851-1986.

#### Electrical Requirements

- **General**
  - Electrical installations shall comply with those Clauses of IEC 60364-7-708 which are applicable to rescue ambulances.
- **Battery and alternator**
  - Batteries shall be positioned to allow maintenance without removing the battery from its securing device. The construction of the battery and all connections to it shall be such as to prevent any possibility of an inadvertent short circuit. Additional batteries may be required to power the medical devices carried on board and the intended use of the rescue ambulance. In such cases, the manufacturer shall ensure optimal charging of the additional batteries without any impact on the primary vehicle battery. The additional circuit shall not draw current more that specified by the manufacturer.
  - Indicative Capacity / Power (These values are given as a broad guideline only. The manufacturers may alter them based on vehicle characteristics and operational requirements) should be as per the below mentioned table



Indicative capacity/ power requirements		
Additional Battery(ies) (if deployed)	Nominal Voltage 12V	80Ah
	Nominal Voltage 24V	63Ah (2x12V)
Alternator Power		700W

- When the engine is idling, electrical stability should be maintained between electrical load and alternator output. In order to achieve this it may be necessary to fit an electrical load prioritization device to the vehicle.
- Manufacturer shall give declaration regarding the certified capacity of the electric system of the vehicle model in the following format:

Sr.No.	Rescue Ambulance Type	Additional Electric Load of Medical Equipment's permissible (Watts)
1	C/ Basic Life Support	XXX

- This shall be prominently displayed in the patient compartment at an appropriate location. Further each electrical socket provided in the patient compartment should be permanently labelled as regards its voltage and amperage.
- **Electrical installation**
  - Recessed externally mounted power connector to enable external power to be provided for operations such as the following:
    - a) Charging battery (ies).
    - b) Operating medical devices, when installed.
    - c) Operating a stand-alone patient compartment heater, when installed.
    - d) Operating an engine pre-heater, when installed.
  - The connector for 220/240 V, shall be a male connector and not interfere with the electrical and mechanical safety.
  - It shall be not possible to start the engine whilst it is connected to an external 220/240 V power supply unless an automatic mechanical disconnection is fitted. If no automatic mechanical disconnection is fitted, the connector shall be on the driver's side. The 220/240 V circuit shall be protected either by an "earth leakage device" with a maximum setting of 30 mA or by a separate transformer. If the protection is given only by an "earth leakage device" there shall be a label near the plug that reads as follows: "CAUTION! CONNECT ONLY TO AN AUTHORISED SOCKET."



- The patient's compartment shall be fitted with a minimum 4 number of connections. For these connections a permanent power supply shall exist.
- Any additional electrical systems fitted to the base vehicle shall be separate from the base vehicle electrical system and the body or chassis shall not be used as an earth return for additional circuits. All circuits in the additional system(s) shall have separate overload protection. Overload protection may consist of either fuses or so called Electronic Management Control systems. All circuits shall be well defined and cables clearly marked at the connection points and at a maximum of 1m intervals along its length.
- The system shall have enough circuits and be so constructed that when/if a circuit fails all illumination and medical technical equipment can be switched to an alternative power source.
- The wiring and, where applicable conduits, shall withstand vibrations. No wiring shall be located in or pass through conduit intended for medical gas installation. The wiring shall not be loaded higher than that stated by the wire manufacture.
- Where there are different voltage systems, the connections shall be non- interchangeable.

### **Vehicle Body**

- **Fire safety**
  - All interior materials shall comply with the flammability requirements specified in IS: 15061, as notified under CMV (A) R, 1989 though the standard does not cover rescue ambulance in the scope.
- **Fitment of fire extinguisher**
  - The rescue ambulance shall be equipped with Two fire extinguishers of 2 Kg each.
- **Minimum loading capacity**
  - The minimum loading capacity of at least 2 stretcher facilities in the patient compartment. Serious casualties/ patients must not be transported on patient compartment seat without use of stretcher & proper restraining support provided to the patient.
- **Partition wall**
  - Full partition wall or a partition wall with a door or a window shall separate the driver's compartment from the patient's compartment. Where a door is fitted, it shall be secured against opening if the road rescue ambulance is in motion.



- One or two windows with a minimum separation of 100 mm shall be provided in the partition wall made of material complying with the requirements of CMVR. The windows shall allow direct visual contact with the driver. The opening area of the window shall have a maximum area of 0,12 m<sup>2</sup>. It shall be secured against self-opening and shall have an adjustable blind or other means of preventing the driver being disturbed by the light of the patient's compartment.
- **Openings (Doors, Windows, Emergency Exits)**
  - General
    - a) The driver seat shall comply with the requirements of AIS-023:2005 or IS:15546-2005 as applicable and notified under CMVR. There shall be a minimum of two openings - one at the rear (door/tailgate) and one at the side (door/window) of the patient's compartment. All openings shall have seals to protect against the ingress of water and dust.
    - b) All openings shall comply with the minimum dimensions set out in the following table

		Dimensions in mm
Side Opening (Optional)	Height	1300
	Width	660
Rear Opening	Height	1300
	Width	1050

- **Doors**
  - a) Each external door of the patient's compartment shall be fitted with a security system which enables the following:
    - lock and unlock from inside without use of a key
    - lock and unlock from outside with use of a key
    - Unlock from the outside using a key when the door is locked from the inside.
  - b) **Note:** This security system may be integrated with an optional central locking system. The patient's compartment doors shall be capable of being positively restrained in the open position.



An audible or visual signal shall warn the driver when any door is not completely closed when the vehicle is in motion. The key can be a mechanical or non-mechanical device.

– Windows

- a) In the patient's compartment, there shall be a minimum of two external windows. There shall be one on each side or one on the side and other at the rear. The windows shall be positioned or screened to ensure patient's privacy when required. Windows shall be fitted with safety glasses complying with the requirements of IS:2553 specified under Rule 100 of CMV(A)R, 1989.

– Stretcher loading

- a) Loading area requirements shall be in accordance with the following table.

Loading Angle (Stretcher)	Maximum	160 a
Loading Height (Stretcher)	When the patient is manually loaded or unloaded on the stretcher, the centre of the stretcher handles shall be no more than 975 mm above ground level. The maximum height of either the floor or the loading holding assembly above ground level shall not exceed 900 mm at net vehicle mass plus loose equipment.	
The loading angle should be kept as low as possible		

- b) Where a ramp or lift is installed between ground level and vehicle floor level it shall be covered with a anti-slip surface and capable of taking a constant load of 350 kg. In the event of a power failure the loading device shall be capable of being operated manually.
- 

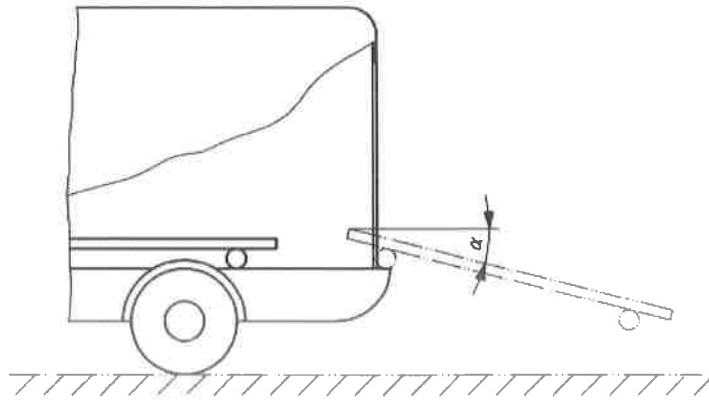

**Figure 1: Loading angle for the stretcher**

### Patient's Compartment

- **General**

- The patient compartment should have minimum internal dimensions of at least 2500 mm (length) x 1800 mm (width) x 1800 mm (height).
- The patient's compartment shall be designed and constructed to accommodate the medical devices listed in the equipment table. The width of the patient compartment after installation of cabinets, etc. shall provide  $40 \pm 15$  cm clear aisle walkway between the main stretcher / undercarriage and the base of squad bench / attendant seats, with the main stretcher located in the street side (non-centered) position.
- The length of the Patient Compartment shall provide at least 64 cm and not more than 76 cm of unobstructed space at the head of the primary patient, when measured from the face of the backrest of the Doctor's/Paramedic's Seat to the forward edge of the stretcher.
- The ceiling, the interior side walls and the doors of the patient's compartment shall be lined with a material that is non-permeable and resistant to disinfectant. The edges of surfaces shall be designed and/or sealed in such a way that no fluid can infiltrate. If the floor arrangement does not allow fluids to flow away, one or more drain with plugs shall be provided. Exposed edges that could come into contact with the occupant's hands, legs, head etc., during normal use shall have a radius of curvature of not less than 2.5 mm except in the case of projections of less than 3.2 mm, measured from the panel. In this case, the minimum radius of curvature shall not apply provided the height of the projection is not more than half its width and its edges are blunted. All installations in the patient compartment above 700 mm from floor level shall not have sharp exposed edges and shall terminate in rounded edges. Sharp edges shall meet the requirements of IS 15223 for M1 and AIS-047 for M2



as amended from time to time. Medical equipment and their holding devices (for example stretchers, platforms, suction units etc.) are excluded. Drawers should be secured against self-opening and where lockers are fitted with doors that open upwards they should be fitted with a positive hold open mechanism.

- The rescue ambulance should be equipped with a lockable drugs compartment with security lock. Floor coverings shall be chosen that will provide adequate grip for the attendant including when wet and should be durable and easy to clean.
- The rescue ambulance should also be fitted with a hand-holding device positioned above the stretcher. The hand-holding device shall be positioned along the longitudinal axis. If the patient's compartment is to be equipped with a non-foldable chair, space shall be provided with a width of at least 600 mm measured at elbow height and a ceiling height above the seat squab of at least 920 mm. Vehicle maintenance equipment (e.g. Spare wheel and Tools) shall be placed such that accessing them does not cause inconvenience to the patient

- **Patient and attendant seating**

- The minimum number of patient and attendant seats should be as per the following table:

<b>Minimum number</b>		<b>2</b>
Position (s)	on one side of the stretcher	1
	on one side of the stretcher upper 2/3 end	1
Position(s) at head of stretcher		-

- **Patient and attendant seat dimensions**

- Patient and attendant seat dimensions shall be minimum of 381 mm X 381 mm per seat. Seats fitted in the patient compartment shall be installed in either forward / sideward / rear-facing positions and shall be fitted with Two Point (Lap Belt) or Three Point Retractable Safety Belts (preferred for forward / rearward facing seats) in conformance with IS:15140-2003. Head restraints shall be fitted as applicable and in accordance with AIS-023:2005 or IS: 15546-2005. Backrests shall be constructed to a minimum dimension of 300 mm × 100 mm.

- **Patient compartment environmental equipment**



- The patient compartment shall be heated, ventilated, and air conditioned as required in accordance with the criteria specified hereto.
- **Air conditioning criteria**
  - The cooling system should be such that, given an outside and inside temperature of 32 °C, the cooling down to at most 27 °C in the patient's compartment should not take longer than 15 min. After 30 min a temperature of at most 25 °C should be reached.
  - The inside temperature should be measured in the centre of the patient compartment and at the mid-point from the cooling outlets (if several outlets are available). The installation of the system shall not encourage exhaust gases entering the patient's compartment.
- **Heating**
  - If the heating system is provided, the system shall be such that given an outside and inside temperature of -10 °C, the heating up to at least +15 °C shall not take longer than 45 min. The inside temperature shall be measured in the centre of the patient compartment and at the midpoint from the heater outlets (if several outlets are available). The installation of the system shall not encourage exhaust gases entering the patient's compartment.
- **Interior lighting**
  - Natural colour balance lighting shall be provided as set out in the table below.
  - **Note:** The colour temperature of the light will change the appearance of skin and organs. Therefore it is important that the interior lighting is suitable for patient care during transport. Although it may not be necessary in rescue ambulance use to define "daylight" or "natural colour balance" in a more exact way other than the colour temperature. The colour temperature of the interior lights should be minimum 4000 Degrees Kelvin.

<b>Patient's compartment illumination - Minimum intensity Lux</b>	
Patient Area (Stretcher)	150
Surrounding Area	50

- Light levels shall be measured along the central longitudinal axis of the stretcher at the head, mid-point and foot position with the stretcher in its normal position for transportation in the rescue ambulance.
- **Interior noise level**
  - The interior noise level in the patient compartment shall comply with requirements of AIS-020. During the test, the Siren of the rescue ambulance shall be kept in the Off position.



- **Ingress of dust and rain water**
  - All doors, windows and hatches shall not allow ingress of dust and rain water when in the fully closed position, when tested in accordance to IS : 11739 - 1986 as amended from time to time, for recording dust ingress in automotive vehicles, and when tested in accordance to IS: 11865 - 2006 as amended from time to time, for water proofing test for automobiles.
- **Mounting systems**
  - Permanent seats and their anchorages in the patients' compartment, designed for use by patients and attendants when the rescue ambulance is in motion, shall comply with the requirements of IS 15546:2005 (for M1 category vehicles) and AIS-023 :2005 (for other than M1 category vehicles).
  - All items e.g. medical devices, equipment and objects normally carried on the road rescue ambulance shall be restrained, installed or stowed to prevent them becoming a projectile when subjected to accelerations/decelerations of 10 g in the forward and rearward directions.
  - When subjected to these accelerations/decelerations, the distance travelled by an equipment or an item shall not endanger the safety of persons on the road rescue ambulance.
  - After being subjected to these accelerations/decelerations:
    - a) no items shall have sharp edges or endanger the safety of persons in the road rescue ambulance;
    - b) the maximum distance the stretcher and any item attached to either the holding assembly or stretcher may travel shall be no more than 150 mm. The displacement of the patient during the test may exceed 150 mm;
    - c) it shall be possible to release all persons in the road rescue ambulance without the use of equipment not carried on the road rescue ambulance.
  - All tested lockers, rails and non-dedicated storage locations or storage devices shall be labelled to show the total maximum permissible weight allowed.

**Testing of Maintain Systems and Fixations of the equipment in the Patient's Compartment**



- Verification of conformity to fixation and maintain systems shall be made when the stretcher(s) / medical device(s) and holding assembly is placed in the mean position of all possible positions available.
- The sample submitted for test, shall be identical to or have the same characteristics and behaviour during test as would the production item or vehicle. Note: Care should be taken that no internal / external additional reinforcement through the rig will modify the behaviour during test.
- The stretchers and chairs shall be loaded with a dummy (as specified in IS 15140 :2003) which is then secured with the restraint system.
- The head end of the stretcher shall be fixed in a position of 15° measured from the horizontal. The lying area of the stretcher tray assembly (holding assembly) shall be in a horizontal position.
- The stretcher shall be fixed on the stretcher's holding assembly. The sedan chair when provided shall also be fixed in its holder.
- The dynamic tests can be carried out with the appropriate stretcher(s) or medical device(s) installed or stowed in the holding system(s) or with weights having the mass distribution and dimensions corresponding to the mass and dimensions of the stretcher(s) and device(s) intended to be installed on or stowed in the holding system.
- In case of dynamic testing, the dynamic test shall be carried out using a patient's compartment assembly or a relevant part of the construction approved by the notified body and the following test method:
  - The test assembly shall be accelerated/decelerated in the longitudinal and transverse and vertical directions accordance with the figure below.
  - The impact speed shall be between 30 km/h and 32 km/h.
  - Test weights for use in lockers should be sand bags with masses in kg increments, with a tolerance of +10% - 0%.



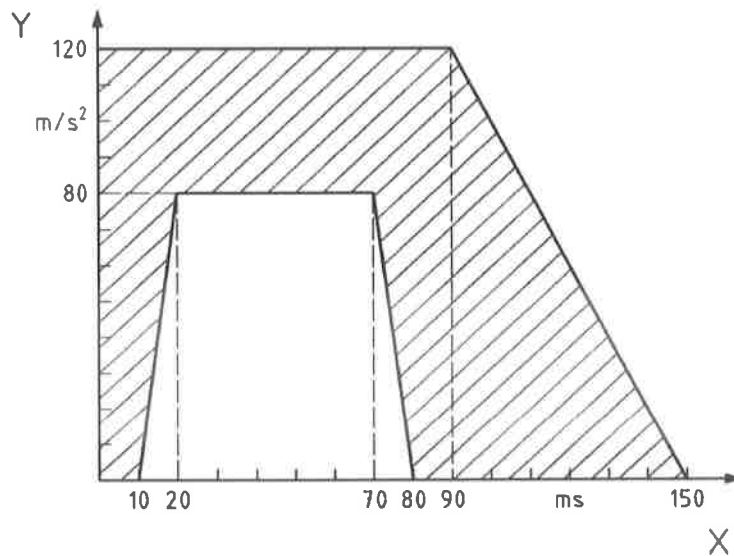

Figure 2: Acceleration impulse

### Medical Devices & On-board equipment

- **Medical Devices Storage**

- All equipment required for a set procedure shall be stored in a specified location. Essential equipment required for use outside the vehicle shall be easily accessible via normally used doors. All equipment shall be securely and safely stowed to prevent damage or injury whilst the vehicle is in motion.

- **Requirements for Medical Devices**

- General

- The device shall be designed for use in mobile situations and in field applications. If a medical device is designated as "portable", which is mandatory for use inside a rescue ambulance (except main stretcher, pickup stretcher, vacuum mattress & long spinal board). it shall be in accordance with IEC 60601-1 and shall

- a) be possible to be carried by one person

- b) have its own built in power supply (where relevant)

- c) be capable of use outside the vehicle

- d) be placed preferably along the street side wall of the patient compartment or along the ceiling ensuring the minimum possible distance to be connected to the patient without hindering the movement of personnel around the main stretcher

- Temperature

- Unless otherwise marked on the device, the device shall function as described in the following two points, when

brought back to room temperature (20°C) after storage in temperatures ranging from -30°C to 70°C.

- Unless otherwise marked on the device, the device shall function throughout the temperature range from 0°C to 40°C.
- Unless otherwise marked on the device, the device shall function for at least 20 min when placed in an environment at -5°C after storage at room temperature (20°C).
- Humidity and ingress of liquids
  - Devices shall comply with ISO 60601-1 and with particular device standards of the series ISO 60601-2 where applicable.
- Mechanical strength
  - General: Where there are not more stringent requirements for mechanical strength in particular devices standards exists, then the following mechanical strength requirements shall apply to medical devices for use in road rescue ambulances.
  - Vibration and bump: After vibration tests and bump test in accordance Vibration & Bump test, the maintain system and device shall function within the tolerances specified by the manufacturer.
  - Free fall: If the medical device is fixed, as defined in ISO 60601-1 it is exempted from the free fall test. Devices which are taken out of holders and/or carried by hand shall be submitted to the free fall test according to the Free Fall test (mentioned subsequently) and shall then function within the tolerances specified by the manufacturer. **Note:** A medical device may consist of fixed and loose components, the free fall test applies to the loose components only.
- Fixation of devices
  - The device shall be restrained by means of a fixation system.
  - The fixation system(s), maintain system(s) or storage system(s) shall hold the device to withstand accelerations or decelerations of 10 g longitudinal (forward, backward), 10 g transverse (left, right) and 10 g vertical.
  - Terminal units and electrical socket outlets shall not be used as part of the fixation system.
  - If rails systems are used, they shall comply with ISO 19054. **Note:** Rail systems consist of e.g. rail supports, rails, rail clamps, equipment mount holders, equipment mounts, equipment pin holders and equipment pins.



- Electrical safety
  - All devices shall be selected and mounted so that no harmful influence to the electrical supplies results.
- User interface
  - Buttons, switches, indicators and controls shall be easily accessible and visible. SI units (except for blood pressure and airway pressure) and standardized graphical symbols where applicable shall be used.
- Gas installation
  - All the components should be certified as per ISO/TC 121/SC6 and ISO-15001:2003 as "Compatibility of Medical Equipment with Oxygen"
  - Source of supply
    - a) The source of supply shall consist of one or more of the following, as per the requirement of the source supplies in the different types of road rescue ambulances.
      - i. Gas in cylinders, e.g. Oxygen
      - ii. Any other compressed medical gas as required for treatment and therapy of patients.
      - iii. Vacuum system
    - b) **Note:** All the components of the source of supply should be certified as per ISO:7396.
    - c) All compressed gas cylinders except for sizes up to 2.2 L Water Capacity, must be stored and used in an upright position with the valve end up. Only special compressed gas cylinders designed and certified for use in a horizontal position can be placed in that position.
    - d) The valve of the compressed gas cylinder when is at a height of more than 1500 mm. from the ground level, the cylinder compartment should be provided with an retractable / foldable / flushed / enclosed foot step to permit the user to stand comfortably to access the cylinder valve at the time of changing the cylinders
    - e) The cylinder compartment should have facility to place the regulators safely at the time of replacing empty cylinders and fitting filled ones.
    - f) Rescue ambulances should never be operated with lesser number of cylinders as specified in equipment table.



– System design

- a) The rescue ambulance whenever fitted with a stationary oxygen system, shall have all the essential components and accessories required for two sets of piped oxygen system which shall include as a minimum:
- i. One no. Pressure Regulator for each of the supply sources (stationary as well as portable)
  - ii. Low pressure, electrically conductive, hose approved for medical oxygen.
  - iii. Oxygen piping concealed and not exposed to the elements, securely supported to prevent damage, and be readily accessible for inspection and replacement.
  - iv. Oxygen piped to a self-sealing duplex oxygen outlet station for the primary patient with a minimum flow rate of 100 LPM at the outlet.

In addition to the above, the ambulance shall have hospital type piped medical oxygen system (manifold) capable of storing and supplying medical grade oxygen. The system should comprise of an oxygen cylinder manifold as specified, a cylinder changing wrench, chained and clipped with/within the oxygen cylinder compartment; a pressure regulator; oxygen piping approved for medical oxygen; a duplex oxygen outlet station with quick-disconnect interface for the primary patient and a second duplex oxygen outlet station with quick-disconnect interface for the secondary patient. A medical grade oxygen pressure regulator with inlet filter & static outlet pressure of 4.12 bars / 60 psi shall be provided at the cylinder manifold. It shall include a pressure gauge, an inlet filter, a safety relief valve; a locking mechanism to prevent settings from being inadvertently changed; shall maintain accurate readings and calibrations during ambulance operation and not be affected by the temperature conditions. The manifold should have oxygen cylinders of B or D size only (minimum one D & one B type cylinder / equivalent). An adapter to refill the cylinders from a bulk cylinder should be provided.

- b) The patient cabin shall have a digital display panel for oxygen supply status. The display panel should be certified for use with Medical Oxygen and should have three individual values displayed to constantly indicate the pressure level of both the cylinders as well as the distribution pressure level. The digital displays should show the actual pressure measured by three individual digital pressure sensors as per the pressure level under monitoring (one each for both the cylinders and one for the line pressure).
- 

- c) The changing from one cylinder to the other should not affect the distribution pressure in any way and this change over should occur as fully automatic operation.
  - d) The rescue ambulance shall be supplied with an emergency oxygen outlet for each of the stationary oxygen system available on any of the walls of the patient compartment easily accessible to the patient head end and connected directly at the output of the pressure regulator of the stationary oxygen system ensuring that any fault in the oxygen distribution system would ensure uninterrupted oxygen supply to the patient. The terminal outlets shall be of the same design and operational criteria as the self sealing duplex outlets of the distribution system.
  - e) Outlets shall be adequately marked and identified and not interfere with the suction outlet, whenever provided.
  - f) Stationary oxygen system shall be accessible from outside of the vehicle and shall be physically isolated from the patient as well as the driver compartment
- Gas piping
    - a) Gas piping shall not pass through cupboards and compartments, all ducts for gas installations or gas piping shall be vented.
    - b) The use of remote high pressure lines and gauges are not allowed.
  - Stationary oxygen supply
    - a) The stationary oxygen supply shall comprise a source in accordance with equipment table (under normal temperature and pressure) pressure regulators and terminal units or pressure regulators with flow metering devices. Rescue ambulances should never be operated with lesser number of cylinders as that designated.
  - Portable oxygen supply
    - a) The portable oxygen supply shall comprise a source in accordance with the equipment table (under normal temperature and pressure) and a pressure regulator with flow metering device.
  - Pressure regulators and flow metering devices
    - a) The pressure regulators shall be directly connected to the source of supply and shall comply with the following as applicable:
    - b) ISO 10524-1:2006, Pressure regulators for use with medical gases - Part 1: Pressure regulators and pressure regulators with flow-metering devices.
    - c) ISO 10524-3:2005, Pressure regulators for use with medical gases - Part 3: Pressure regulators integrated with cylinder valves.
    - d) Flow metering devices for connection to terminal units and for



connection to flow-rate control units shall be of dial type without any floats and shall conform to ISO 15002.

– Terminal units

- a) Terminal units shall comply with the requirements of ISO-7396.
- b) The components of terminal unit should be cleaned as defined in "Compatibility of Medical Equipment with Oxygen" as per ISO/TC 121/SC6 and ISO-15001:2003.
- c) The terminal outlet should have an hexagonal geometrical profile to permit only geometrically matching adapters.
- d) The process of inserting the probe into the terminal unit of the distribution system as well as pressure regulators shall be:
  - i. an axial force not exceeding 100N and / or
  - ii. a torque not exceeding 1 N-m
- e) The process of releasing the probe from the terminal outlet should be by
  - i. applying an axial force having torque not more than 1 N-m and not less than 0.1 N-m.
  - ii. applying a push or pull force of not more than 110 N and not less than 20 N.
- f) When all locking provisions have been released, disconnection of the probe from the terminal unit shall require a force of not more than 100 N.
- g) Danger to personnel can occur as a result of the rapid expulsion of probes from terminal units. The design should prevent this from occurring.
- h) The terminal outlets should be colour coded as per ISO-32:1977 colour coding.

– Pneumatic power supply

- a) If the road rescue ambulance is equipped with terminal units, the range of operating pressure shall be
  - i. for compressed medical gases  $3.5 \pm 0.5$  Bar
  - ii. for vacuum  $\leq 0.4$  Bar absolute pressure and the maximum allowable pressure change between the source of supply and the terminal units shall be
  - iii. for compressed medical gases 10 % at a flow of 40 l/min;
  - iv. for vacuum 20 % at a flow of 25 l/min.



- Additional outlet connectors
  - a) For road rescue ambulances complying with Pneumatic power supply, one additional outlet connector (i.e. a terminal unit or a gas specific connection point) complying with the primary outlet shall be fitted in addition to the outlet connectors necessary for the devices intended to be normally used.
- Test Pressure
  - a) The gas piping shall withstand a pressure of 8 Bar i.e. twice the maximum operating pressure of 4 Bar.
  - b) Note: This pressure is also the maximum pressure supplied by pressure regulators in single fault condition.
- Pin-Index Cylinder Valves
  - a) Pin-index outlet connections of cylinder valves shall comply with IS 3224.
- Flexible Hoses
  - a) Flexible hoses for connecting medical devices to outlet connectors (i.e. terminal units or a gas-specific connection points) shall comply with ISO 5359-2008. If flexible hoses are used between the pressure regulators and the terminal units, the requirements of ISO 11197 apply.
- Alarms
  - a) The alarm level would be as per IEC 60601-1-8-2006.
- Marking and Instructions
  - a) Marking and instructions for use shall comply with Annexure 1 of AIS 125. Operating and maintenance instructions, service records and any other appropriate regulations shall accompany the product.
  - b) Standardized symbols should be used or it should be written in English or any other local language of the area where the equipment is to be used. Usage of any other local languages are not mandatory but is only advised.
- Maintenance
  - a) The manufacturer shall supply instructions for carrying out preventive maintenance.
- **Mechanical Strength - Test Methods for Medical Devices for use in Road Rescue Ambulances**
  - Vibration and bump test - The medical devices shall be submitted to the following tests:
    - Vibration (sinusoidal) according to IEC 60068-2-6, Test Fc



- Frequency range: 10 Hz to 150 Hz
  - Amplitude/acceleration:  $\pm 0,15$  mm/2 g
  - Sweep rate: 1 octave/minute
  - Number of sweep cycles: 4 in each axis
  - Random vibration broad-band - reproducibility medium according to IEC 60068-2-64, Test Fh
  - Acceleration Spectral Density 10 Hz to 20 Hz:  $0,05$  g<sup>2</sup>/Hz
  - Acceleration Spectral Density 20 Hz to 150 Hz:  $0,05$  g<sup>2</sup>/Hz, -3 dB/Octave
  - Total RMS acceleration 1,6 grms
  - Duration/axis/mounting: 30 min
  - Bump according to IEC 60068-2-27, Test Ea
  - Peak acceleration: 15 g
  - Acceleration Spectral Density
  - Pulse duration: 6 ms
  - Number of bumps: 1000
  - Direction: vertical, with the medical device in its normal operating position(s)
- Free fall - The medical device shall, while functioning, be submitted to the following test:
- Free fall according to IEC 60068-2-31, Test Ec
  - Height of fall: 0,75 m
  - Number of falls: One on each of the six sides / surfaces of the device

- **List of Equipment**

- Supplementary devices may be introduced depending on local requirements. Where applicable the equipment shall be available across the full age range of patients.
- The minimum mass including a mass reserve required for the listed sanitary, medical and technical devices should be 225 kg.
- The equipment shall comply with the standards mentioned against them if any. Tests conducted by notified international bodies as per the relevant standards shall be acceptable if verifiable certified copies of the test reports and certificates are available.



- All rescue ambulances must be fitted/ carry the following list of equipment with them at all times.

S No.	Equipment	Quantity
1	Main automatic loading stretcher (length 1900 mm - 1970mm, width 530 mm to 570 mm with loading capacity of 150 kg) conforming to EN 1865 standard	2
2	Scoop stretcher (lightweight aluminum stretcher, length 1600 mm - 2000 mm, width - minimum 42 cms, loading capacity - minimum 150 kgs) conforming to EN 1865 standard	2
3	Vacuum mattress (length 1900 mm - 1970 mm, width 530 mm to 570 mm with loading capacity of minimum 150 kg) conforming to EN 1865 standard	2
4	Long spinal board (with head immobilizer & securing straps and plastic material at high strength, should be waterproof & conforming to EN 1865 standard	2
5	Set of fractures/ splints made of mouldable metal or alloy (aluminum) - sizes for both children & adults and for hand & wrist, half arm, full arm, foot and ankle, half leg, full leg (all splints should be washable and reusable)	2 each
6	Cervical collar for both kids & adults (should have pre-molded chin support, locking dials and rear ventilation panel and an enlarged trachea opening, should have high density polyethylene and foam padding, should be X-ray lucent and easy to clean and dis-infect)	4 each
7	KED extrication device	1
8	Stationary oxygen - Minimum 2 Nos. of 10 L water capacity cylinders at maximum 150 kgf/ cm <sup>2</sup> filling pressure manufactured as per IS:7285 & certified by chief controller of explosives, Nagpur along with 3/8 bull nose valve as per IS:3224	2
9	Portable oxygen - Minimum 1 Nos. of 10 L water capacity cylinders at maximum 150 kgf/ cm <sup>2</sup> filling pressure manufactured as per IS:7285 & certified by chief controller of explosives, Nagpur along with 3/8 bull nose valve as per IS:3224	2
10	Manual resuscitator with oxygen inlet and mask	2

S No.	Equipment	Quantity
11	Airways (nasopharyngeal airways of size 6.5 mm, 7.5 mm, 7 mm, 8.5 mm & 8 mm & oropharyngeal of size 0, 1, 2, 3 & 4)	2 each
12	Electric portable suction aspirator with air flow of at least 30 L/ min and vacuum level of at least 600 mm Hg (ISO 10079-1-1999)	2
13	Manual portable suction aspirator conforming to IS 4533: 1995	3
14	Suction Catheter (12 & 16)	2 each
15	Laryngeal mask airway (for both kids & adults)	2 each
16	Infusion solutions, Litre	4
17	Equipment for injections and infusions set (IV Sets)	2
18	Infusion mounting	2
19	Tourniquet (multiple sizes) conforming to IS 7971:1987	2
20	Automatic External Defibrillator with ability to deliver shock up to 200 joules through biphasic technology; should also consist of an audio alarm	1
21	Nebulizer conforming to IS 9462: 1980	2
22	Manual B.P. Monitor (cuff size: 10 cm - 66 cm)	2
23	Portable Automatic B.P., heart rate & saturation monitor	2
24	Oximeter of ISO 9919 standards	2
25	Stethoscope conforming to IS 3391: 1965	2
26	Thermometer (min: 28 degrees to 42 degrees Celsius)	2
27	Device for blood sugar determination	2
28	Diagnostic Light	2
29	Blanket	2
30	Non woven stretcher sheet	2
31	Kidney bowl	2
32	Vomiting Bag	2
33	Non-glass urine bottle	2
34	Waste bag	2
35	Bed Pan	2
36	Sharps container	2
37	Sterile surgical gloves, pairs	5

S No.	Equipment	Quantity
38	Non-sterile gloves for single use	100
39	Basic protective clothing including high visibility reflective jacket	3
40	Safety/ debris gloves	3
41	Safety shoes	3
42	Safety helmet	3
43	Personal protection equipment against infection including disinfectants	3
44	Fire extinguishers (minimum 2 kgs) complying with IS: 13849 or IS: 2171)	2
45	Hammer	1
46	Shovel	1
47	Hydraulic Cutter/ Spreader	1
48	Warning Triangle Lights	4
49	Spotlight	1
50	Public addressal system	1
51	Two way radio transceiver or better technology for mobile communication with highway surveillance team, tow away crane & control room	1
52	Internal phone within patient compartment for communication with driver	1
53	Automated vehicle tracking system with GPS technology for continuous tracking of vehicle location	1

- List of medicines & dressing material to be carried in rescue ambulance at all times:

S No.	Medicines & Dressing Material	Quantity
1	Band-Aids	20
2	BETADINE SOLUTION 500ml (bottle)	1
3	Cotton roll 500gm	1
4	Crape bandage 15cm x 4mtr	2
5	Crape bandage 7cm x 4 mtr	2
6	DRESSING PAD 10CM X 10CM (pre-sterilized)	10
7	DRESSING PAD 10CM X 20CM(pre-sterilized)	10



S No.	Medicines & Dressing Material	Quantity
8	Elasto plast (dyna plaster) 10cm	2
9	Gauge cloth 80cm x 18 mtr	1
10	Gauge rolls 4 “	1
11	Gauge rolls 6 “	1
12	Plain bandage of various sizes	3
13	HYDROGEN PEROXIDE 400ML (bottle)	1
14	Micropore tape 2”,4”	2
15	SURGICAL SPIRIT BOTTLE 500ML (bottle)	1
16	Glucose 100gm	2
17	I V FLUID DEXTROSE 25% (bottle)	5
18	I V FLUID NORMAL SALINE (bottle)	10
19	I V FLUID RINGER (RL) (bottle)	10
20	I V FLUID 5% GNS (bottle)	5
21	Inj adrenaline 1ml	5
22	Asthalin-neubilizing solution	5
23	Inj atropine 1ml	20
24	Inj avil 2ml	5
25	Budesonide-neubilizing solution	5
26	Inj distilled water 5ml	5
27	Inj dizazepam 2ml	5
28	Inj hydrocortisone 100 mg	5
29	Inj lasix 2ml	5
30	Inj paracetamol 2ml	5
31	Inj rantidine 2ml	5
32	Inj tramadol 2ml	5
33	Inj tranexaminic acid	4
34	Inj neostigmine	4
35	Inj haemaccel	2
36	Inj mannitol	5
37	Inj sodabcarb 7.5%	5
38	Inj metaclopramide	5
39	Inj phenytoin	5
40	Inj hyosymine bromide or dicyclomine hydrochloride	5
41	Inj methargin	5

S No.	Medicines & Dressing Material	Quantity
42	Ors 4.20gm	10
43	SYP ANTACID ANAESTHETIC GEL (bottle)	1
44	SYP PARACITAMOL 60ML (bottle)	1
45	TAB ACTIVATED CHARCOAL (strip)	1
46	TAB CLOPIDOGREL (strip)	1
47	TAB DISPRIN/ASPRIN (strip)	1
48	TAB PARACETAMOL (strip)	1
49	TAB ISOSORBRITE DINITRATE 5MG SUBLINGUAL (strip)	1
50	XYLOCAINE (WOCAINE GEL) 2% 30GM JELLY (tube)	1

### Rescue Ambulance Manpower

- **1 trained EMT staff with the following qualifications/ experience**
  - Basic qualification of EMT - Diploma in E.M.T
  - B.Sc. (PCB) with certification in BLS/ ALS/ ACLS/ ITLS (or) B.Sc Nursing/ GNM/ ANM (or) B.Pharma/ D. Pharma or any other equivalent paramedical course from recognized university/institution of IMC/INC
  - Minimum 2 years of relevant experience in first-aid and life saving emergency skills including spinal immobilization, bleeding control, oxygen therapy, defibrillation and medicine administration.
  - At least one training (minimum one month) in tertiary care institution or at a recognized institute with experience in handling life-saving equipment.
  - Basic training in extrication
- **1 Driver**
  - Valid license to drive an rescue ambulance
  - Ability to read/ write & maintain log books
  - Basic training in delivering first aid & victim extrication

### Rescue Ambulance Branding & Recognition

- **Recognition and visibility of rescue ambulances**

The Rescue Ambulance Conspicuity Code is split into six Sections.

- i. Colour
- ii. Conspicuity Improving Items (C2I)
- iii. Emblems
- iv. Warning Lights



- v. Sirens
- vi. Recognition of personnel

The Section “colour” describes the vehicles basic colour. The Section “Conspicuity Improving Items” or “C2I” includes all Symbols, Marking and Striping defined as such by this standard. The Section “Emblems” refers to every item that doesn’t fall under the definition of C2I which can be private company signs or corporate identities. The Section “Warning Lights” describes colour, position, alignment, luminosity, photometric brightness, flash patterns and electrical current consumption of all used warning lights. The Section “Sirens” determines the volumes, frequencies and electrical current consumption of all used sirens and speakers.

- **Colour**

- The basic colour of the complete exterior should be brilliant blue as per Annexure-I attached, front, rear and side bumpers included. The colour should be weather resistant and withstand daily cleaning and washing.

- **Conspicuity improving items**

This definition includes all marking and symbols as shown in the figure 3 and 4 below. All C2I-markings should be in brilliant red, RAL- Code 3024 and in retro reflective quality. Conspicuity improving items: “AMBULANCE” markings, the Star of Life and the emergency number symbol. All “AMBULANCE” markings must follow a 7:1 ratio, length to height.

- **Front:** No less than 50% of the front side of the vehicle should be brilliant Blue in contrast to no less of 10% brilliant red. The word “AMBULANCE” on brilliant blue background, minimum of 65% of the hood width, shall be in mirror image (reverse reading) for mirror identification by drivers ahead.
- **Side:** The side of the vehicle should be equipped with a two lined red on the white ground colour as shown in figure 4. The vehicle side should be brilliant blue followed by an “AMBULANCE” marking on the same height. “Star of Life” symbol, with a size of 40cm x 40cm, and the emergency number logo, with a size of 40cm x 75cm. The vertical centre from both of them should match the vertical centre of the side windows of the driver cabin. The words “Basic Life Support” shall be marked respectively just above the word ambulance in size no less than 50% of the size of the word “AMBULANCE”

- **Emblems**

- NHA emblem should be placed in allowed instead of “XXX” in a non-reflecting manner and the size can’t be bigger than 60% of the “AMBULANCE” markings. Ambulance Calling Number 1033 must be

displayed prominently on the side and back of the Road rescue ambulance.

- **Warning lights**

- All warning lights have to be mounted rectangular to the horizontal ground. They must provide 100% of their intensity in a vertical angle of  $\pm 4$  degrees and 50% in a vertical angle of  $\pm 8$  degrees. The minimum intensity is for blue and red lights at 100cd at daylight and 200cd in the night. The horizontal minimum angle should be at least 45 degrees. All lights must flash between 2Hz and 4Hz and should be mounted as on the graphic below

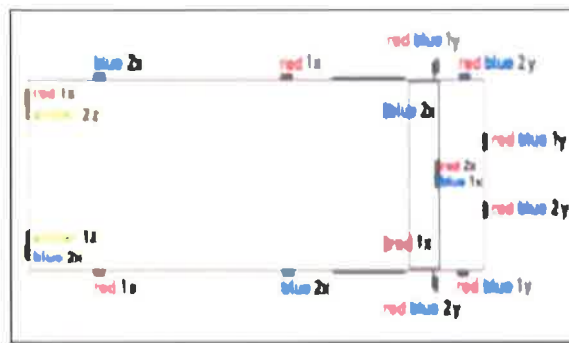

#### Flash Pattern

1. Indicates light flashing the same time
2. Indicates light flashing
3. 180 degree out of phase with 1
4. 'x' indicates 'ON' lights in primary and secondary mode
5. 'y' indicates 'ON' light only in primary mode
6. 5 'z' indicates 'ON' light only in secondary mode

- Lights marked with “red blue” must show red and blue in one piece one at a time. In daytime they must flash red in nighttime they must flash blue. Two lights have to be mounted in the lower middle windshield only flashing to the outside of the car. All lights should be flashing as shown in the graphic above. To switch from Primary into Secondary Mode there has to be one switch that allows only one mode.

- **Sirens**

- All siren loudspeakers have to be mounted on the front of the vehicle. Hidden installation is allowed. The main sound direction must be in driving direction. Permitted are wail and yelp signals that cycle between 10-18 respectively 150-250 per minute at an sound pressure level of 110dB(A) to 120dB(A). The sirens should be tested in accordance with IS 1884 (though not covered in the standard). The frequency range must be at least one octave and should be between 500Hz and 2.000Hz. An additional electronic air horn can be used. Further there should be a public address system that can be worked

at all times ergonomically from the driver's seat. The siren switch can only be used if the warning lights are on.

- **Recognition of personnel**
  - Safety garments for rescue ambulance personnel should conform to at least ISO 14116:2008.



Figure 3: Rescue Ambulance - Front View

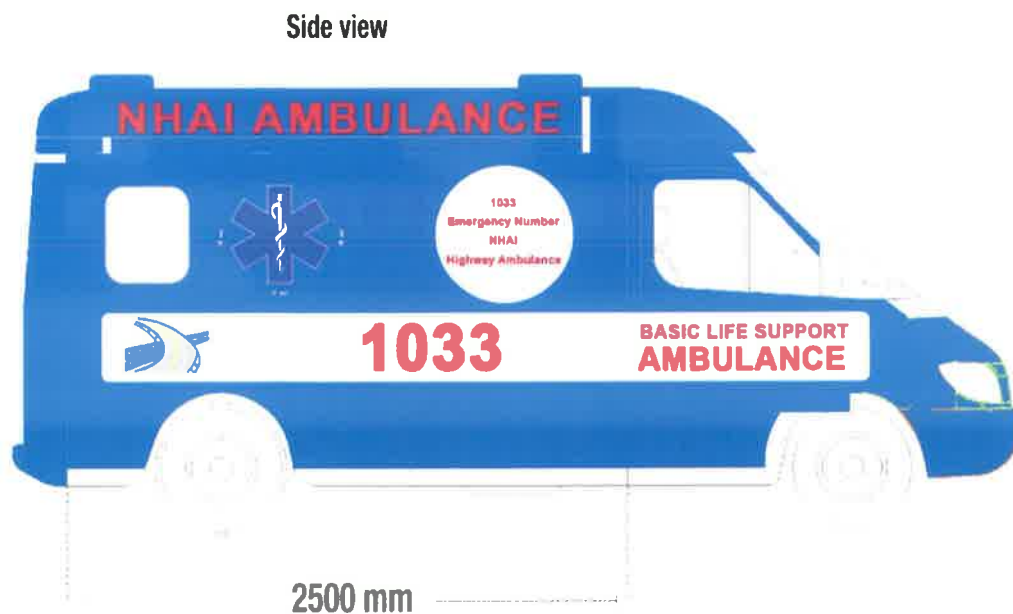

Figure 4: Rescue Ambulance Side View

Brilliant Blue Colour Code : C: 87%, M: 74%, Y: 0%, K: 0%

## Patrol Vehicle Specifications

Every Patrol Vehicle (PV) should adhere to the minimum specifications as described below:

### General Vehicle

Type	Description
<p><b>1. Vehicle type</b></p>	<ul style="list-style-type: none"> <li>• PV should be a large size Sport Utility Vehicle(SUV) or Multi Utility Vehicle(MUV) with a seating capacity of minimum 4 people</li> <li>• PV should have trunk with open ceiling at the rear end of the vehicle with minimum trunk dimensions of 1400mm x 1400mm x 900mm where 1400mm is the length of trunk measured from inside, 1400mm is the breadth of trunk measured from inside and 900 mm is the height measured from the surface of trunk to the top ceiling of the seating area of the vehicle</li> <li>• The PV should be a new vehicle and should not have covered more than 2000 km at the time of procurement (from date of first registration)</li> <li>• PV should be able to accelerate from 0km/ h to 80 km/ h within 20s with a top speed of 80 km/h when tested in accordance with IS: 11851-1986</li> </ul>
<p><b>2. Two-External equipments</b></p>	<ul style="list-style-type: none"> <li>• PV should have high intensity red and blue blinkers along with light bar mounted on top of a vehicle</li> <li>• PV should have 1 Portable Variable Message Sign(VMS) for large display of warning. The portable VMS Should have a single line display with the minimum height of 200 mm for each character. The overall length of signboard should be atleast 1500mm and display color should be red. VMS should be clearly readable from 50 m distance.</li> <li>• PV should have provision for fog lights</li> <li>• PV should have beacon lighting - white color flashing light mounted at the top of the vehicle</li> </ul>
<p><b>3. Branding and recognition</b></p>	<p><i>The PV conspicuity code is split into three Sections</i></p> <ul style="list-style-type: none"> <li>○ Color</li> <li>○ Conspicuity Improving Items</li> <li>○ Recognition of personnel</li> </ul> <p>The Section "Color" describes the vehicle basic color. The Section "Conspicuity Improving Items" includes all Symbols,</p>



Type	Description
	<p>Marking and Striping defined as such by this standard. The Section "Recognition of personnel" describes the dress code and safety garments of Patrol Vehicle personnel.</p> <ul style="list-style-type: none"> <li>• <b>Color</b> <ul style="list-style-type: none"> <li>- The basic color of the complete exterior of PV should be brilliant blue, front, rear and side bumpers included. The color should be weather resistant and withstand daily cleaning and washing.</li> </ul> </li> <li>○ <b>Conspicuity Improving Items</b> <ul style="list-style-type: none"> <li>○ This definition includes all marking and symbols as shown in the sketch below. The vehicle should be painted with brilliant blue on the entire body.</li> <li>○ PV should have "NHAH Highway Surveillance Unit" written on all four sides of the vehicle in brilliant red color of retro reflective quality as shown in figure 5.</li> <li>○ PV should have a text at the centre of all four sides of the vehicle with "Emergency Number" written on top and "1033" written right below "Emergency Number" in brilliant red color of retro reflective quality. The "Emergency Number" marking should be atleast 10 cm high and the ratio of height of "1033" and "Emergency Number" should be 2:1</li> </ul> </li> <li>○ <b>Recognition of personnel</b> <ul style="list-style-type: none"> <li>○ All PV Personnel should wear brilliant blue color uniform including brilliant blue color jackets required in winters</li> <li>○ Safety garments for PV personnel should conform to at least ISO 14116:2008.</li> </ul> </li> </ul>

The branding and recognition pattern of PV described above should resemble with the one shown in the sketches below:





Figure 5 : PV - Side View

### Equipments

Following are the list of equipments and specification of each to be kept in working condition in every PV

Type	Description
1. Tracking equipments	<ul style="list-style-type: none"> <li>• Automatic vehicle tracking system with GPS technology for tracking vehicle's current location; Information to be viewable on GIS software</li> </ul>
2. Communication Equipments	<ul style="list-style-type: none"> <li>• 1 Two- way radio device with antennae or better technology for mobile communication, for communication with Regional Command Center and with on-road units. Should have a sufficient range to communicate in the entire region(or state) &amp; sufficient battery life (12 hours+)</li> <li>• 1 Public address system consisting of microphone, amplifier and loudspeaker to address the traffic in case of accident, should have minimum 100 W amplifier with loud sound</li> <li>• 1 Cellular phone for communication</li> </ul>
3. General Surveillance Equipments	<ul style="list-style-type: none"> <li>• 1 Digital Camera with minimum 5 megapixel camera quality</li> <li>• 2 white color high intensity torch lights with two set of spare batteries</li> <li>• 3 Orange color reflective safety jacket along with gum boots and helmet (1 for every attendant)</li> </ul>

Type	Description
	<ul style="list-style-type: none"> <li>• 3 Rain suit (1 for every attendant of Surveillance Unit)</li> <li>• 2 units of liquid containers with minimum 5 L capacity for carrying petrol/diesel along with a funnel</li> <li>• 1 water container</li> <li>• 1 rope of minimum 20 m length</li> <li>• 10 orange/red color reflective flags of atleast 300 mm height</li> <li>• 1 whistle</li> <li>• 2 hand signals</li> </ul>
<p><b>4. Vehicle Repairing Equipments</b></p>	<ul style="list-style-type: none"> <li>• 3 pairs of leather gloves</li> <li>• 2 ton hydraulic jack capable of lifting car, bus and light trucks, should be able to attain a maximum height of atleast 300 mm</li> <li>• 1 Heavy duty steel towing chain of minimum 1.5 m length</li> <li>• 1 Animal hook</li> <li>• 1 Tire gauge with minimum 0-50 psi range and tire sealant</li> <li>• 1 Portable tire inflator pump capable of filling tires upto a pressure of 50 psi; should be able to inflate tires of cars, buses and light trucks</li> <li>• 1 pair of Starter leads with multimeter: For making connections with external power source</li> <li>• 1 Tow bar for towing purposes</li> <li>• 1 Mechanical toolkit with equipment like hammer, fencing pliers, mallet, ratchet wrench set, screwdriver set, battery brush, etc.</li> </ul>
<p><b>5. Extrication &amp; First Aid Equipments</b></p>	<ul style="list-style-type: none"> <li>• 1 Portable electric windshield cutter operated by battery or external power source, should be able to cut all type of windshields causing minimum glass dust</li> <li>• 1 Hydraulic/electric portable hand cutter and spreader combined tool, should be able to cut off vehicle parts, metal structure, steel plate. Should have maximum cutting force &gt; 250 KN, spreading force <math>\geq</math> 25KN with opening distance of Blades &gt; 150 mm</li> <li>• 4 wooden wedges, 4 rectangular wooden blocks of minimum dimensions 150 * 120 * 60 mm for stabilizing light and heavy vehicles</li> </ul>



Type	Description
	<ul style="list-style-type: none"> <li>• Two struts capable of stabilizing a vehicle of minimum 1500 kg weight</li> <li>• 1 Long spinal board (with head immobilizer &amp; securing straps and plastic material at high strength, should be waterproof &amp; conforming to EN 1865 standard)</li> <li>• 1 Cervical collar for both kids &amp; adults (should have pre-molded chin support, locking dials and rear ventilation panel and an enlarged trachea opening, should have high density polyethylene and foam padding, should be X-ray lucent and easy to clean and dis-infect)</li> <li>• 1 KED extrication device for both kids and adults should be made of polymer/wooden bars in a nylon jacket</li> <li>• 1 Pick-up stretcher conforming to EN 1865 standard (minimum usable length of 1650 mm and extendable to a minimum of 2010 mm, minimum width of 400 mm, mass not more than 11 kilograms &amp; should have minimum loading capacity of 150 kilograms)</li> <li>• 1 First aid kit</li> <li>• 2 woolen blankets</li> <li>• 1 Map locating nearest hospital, police station, fire station</li> </ul>
<p><b>6. Scene Management Equipments</b></p>	<ul style="list-style-type: none"> <li>• Minimum 10 Reflective cones of 750 mm each, should be orange in color with retro-reflectorised white band and a heavy rubber base with minimum possibility of being displaced by wind/vehicular traffic</li> <li>• 4 kg dry Powder Fire Extinguisher</li> <li>• 3 pairs of Rubber gloves</li> <li>• 1 Hard bristle broom</li> <li>• 1 Shovel</li> <li>• Sign boards with messages <ul style="list-style-type: none"> <li>○ 3 - "Accident ahead"</li> <li>○ 3 - "Lane merging"- 3 units</li> <li>○ 3 - "Direction arrows" - 3 units</li> <li>○ 2 - "Speed Limit" (80, 60, 40)</li> <li>○ 2 - "Keep left/right"</li> <li>○ 2 - "Lane closure"</li> <li>○ 2 - "Men at work"</li> <li>○ All signs should be of retro reflective sheeting of High intensity grade or Prismatic grade</li> </ul> </li> </ul>

Type	Description
	<ul style="list-style-type: none"> <li>• 9 units of Sign stand (for triangular and circular sign) for height between 1.5 m to 2 m</li> <li>• 2 Reflective type barricade, tape</li> <li>• 3 pairs of safety glasses and masks for protection of safety officers from glass debris/ airborne dust.</li> <li>• 10 kg sealed bucket with lime or cement inside</li> </ul>

### Manpower and Trainings

Type	Description
1. Highway surveillance in-charge	<ul style="list-style-type: none"> <li>• <i>1 Highway surveillance in-charge should be appointed per shift per vehicle</i></li> <li>• Employee appointed should have minimum 2 years of relevant experience in route patrolling and traffic management.</li> <li>• Employee appointed should be able to read/write and maintain log books.</li> <li>• Employee appointed should undergo trainings including fields such as <ul style="list-style-type: none"> <li>○ Vehicle use and maintenance</li> <li>○ Safety policies</li> <li>○ Radio and communication procedures</li> <li>○ Public relations/ customer service</li> <li>○ Defensive driving</li> <li>○ Public relations/customer service</li> <li>○ Maintenance of traffic</li> <li>○ Vehicle recovery procedures</li> <li>○ Victim extrication procedures</li> <li>○ Extinguishing vehicles fires</li> <li>○ Basic first aid training</li> <li>○ Work side protection</li> <li>○ Minor vehicle repairs</li> </ul> </li> </ul>
2. EMT	<ul style="list-style-type: none"> <li>• <i>1 EMT should be appointed per shift per vehicle</i></li> <li>• Basic qualification of EMT - Diploma in E.M.T.</li> <li>• B.Sc. (PCB) with certification in BLS/ ALS/ ACLS/ ITLS (or) B.Sc Nursing/ GNM/ ANM (or) B.Pharma/ D. Pharma or any other equivalent paramedical course from recognized university/institution of IMC/INC</li> <li>• Employee appointed should have minimum 2 years of relevant experience in first-aid and life saving emergency skills including spinal immobilization, bleeding control,</li> </ul>

Type	Description
	<p>oxygen therapy, defibrillation and medicine administration.</p> <ul style="list-style-type: none"> <li>• Employee appointed should undergo atleast one training (with duration of minimum one month) in tertiary care institution or at a recognized institute with experience in handling life-saving equipment.</li> <li>• Basic training of employee should include fields such as <ul style="list-style-type: none"> <li>• Vehicle and equipment use and maintenance</li> <li>• Victim extrication from a crashed/damaged vehicle</li> <li>• Safety policies</li> <li>• Radio and communication procedures</li> <li>• Public relations/customer service</li> </ul> </li> </ul>
<p><b>3. Driver/helper</b></p>	<ul style="list-style-type: none"> <li>• 1 driver/ helper should be appointed per shift per vehicle</li> <li>• Employee appointed should have a valid license to drive a SUV vehicle.</li> <li>• Employee appointed should be able to read/ write &amp; maintain log books.</li> <li>• Basic training of employee should include fields such as <ul style="list-style-type: none"> <li>○ Vehicle driving along multiple shifts</li> <li>○ Minor repairing of vehicle</li> <li>○ Vehicle and equipment use and maintenance</li> <li>○ Radio and communication</li> <li>○ Work site protection</li> </ul> </li> </ul>

