

# **National Highways & Infrastructure Development Corporation Limited**



## **REQUEST FOR PROPOSAL (RFP)**

### **FOR**

**CONSULTANCY SERVICES AS AUTHORITY'S ENGINEER FOR SUPERVISION OF**

**(I) Construction & Upgradation to 2 lane with paved shoulder from Design Km. 67.805 (at the end of Km 83rd tunnel near Dhrabshala) to Km 80.675 (Dulhasti) of 12.87 Km length on Khellani – Kishtwar –Chattroo section of NH-244 in the Union Territory of Jammu & Kashmir on EPC mode (Pkg –III). &**

**(II) Construction of Kishtwar bypass with 2 lane with paved shoulder from Design Km. 80.675 (Dulhasti) to Km 95.550 (bandarkoot ) of 14.88 Km length on Khellani – Kishtwar –Chattroo section and a link road to Kishtwar town of 1.871 km on NH-244 in the Union Territory of Jammu & Kashmir on EPC mode (Pkg –IV). &**

**(III) Construction /Up gradation 2 lane with paved shoulder from Design Km 95.55 (Bandarkoot ) to Km. 111.06 (Chattroo) of 15.52 Km length on Khellani – Kishtwar –Chattroo section on NH-244 in the Union Territory of Jammu & Kashmir on EPC mode (Pkg –V).**

**(National Competitive Bidding)**

**(Through INFRACON and CPP Portal)**

**[Online mode]**

**NATIONAL HIGHWAYS & INFRASTRUCTURE DEVELOPMENT CORPORATION LTD  
(MINISTRY OF ROAD TRANSPORT & HIGHWAYS, GOVT. OF INDIA)  
3RD FLOOR, PTI BUILDING, 4-PARLIAMENT STREET, NEW DELHI – 110001**

**June, 2021**

## CONTENT

Sr. No.	Particulars	Page Nos.
1	<b>SECTION 1:</b> Information to Consultants	3-8
2	<b>SECTION 2:</b> Letter of Invitation	9-19
	<b>Datasheet</b>	20-24
	<b>Appendix-EC</b>	25-38
3	<b>SECTION 3:</b> Format for Submission of Firms Credentials.	39-42
4	<b>SECTION 4:</b> Format for Submission of Technical Proposal.	43
	<b>Appendix B-1-</b> Technical proposal submission form.	44
	<b>Appendix B-2-</b> Site Appreciation	45
	<b>Appendix B-3-</b> Approach paper on methodology for performing the assignment	46
	<b>Appendix B-4-</b> Facility for field investigation and testing	47
	<b>Appendix B-5-</b> Composition of the Team and Task(s) of each Team member	48
	<b>Appendix B-6-</b> Curriculum vitae of proposed Professional staff.	49-50
	<b>Appendix B-7-</b> Time schedule for deployment of Professional staff	51
	<b>Appendix B-8-</b> Activity (works) schedule.	52
	<b>Appendix B-9-</b> Affidavit – Correctness of Experience claimed by the Firms	53
	<b>Appendix B-10-</b> Integrity Pact	54-59
5	<b>SECTION 5:</b> Format for submission of Financial proposal.	61
	<b>Appendix C-1</b> Financial proposal submission form	62-63
	<b>Appendix C-2</b> Summary of costs	64
	<b>Appendix C-3</b> Breakdown of costs	65-68
6	<b>SECTION 6:</b> Terms of Reference.	69-85
	<b>Enclosure-A</b>	86-87
	<b>Enclosure-B</b>	88-93
	<b>Annexure I-</b> Daily Inspection Report in construction period	94
	<b>Annexure II-</b> Daily Inspection Report in O&M period	95
	<b>Annexure III-</b> Weekly Inspection Report in O&M period	96-99
	<b>Annexure IV-</b> Month of survey for equipment based road condition assessment	100-101
	<b>Annexure V-</b> Monthly Progress Report in Construction Phase	102-156
	<b>Annexure VII:</b> Output Format From Network Survey Vehicle And FWD Testing	157-185
7	<b>SECTION 7:</b> Draft Form of Contract.	186-227

## REQUEST FOR PROPOSAL (RFP)

### SECTION 1: INFORMATION TO CONSULTANTS

**Subject: [CONSULTANCY SERVICES AS AUTHORITY’S ENGINEER FOR SUPERVISION OF**

- (I) Construction & Upgradation to 2 lane with paved shoulder from Design Km. 67.805 (at the end of Km 83rd tunnel near Dhrabshala) to Km 80.675 (Dulhasti) of 12.87 Km length on Khellani – Kishtwar –Chattroo section of NH-244 in the Union Territory of Jammu & Kashmir on EPC mode (Pkg –III). &**  
**(II) Construction of Kishtwar bypass with 2 lane with paved shoulder from Design Km. 80.675 (Dulhasti) to Km 95.550 (bandarkoot ) of 14.88 Km length on Khellani – Kishtwar –Chattroo section and a link road to Kishtwar town of 1.871 km on NH-244 in the Union Territory of Jammu & Kashmir on EPC mode (Pkg –IV). &**  
**(III) Construction /Up gradation 2 lane with paved shoulder from Design Km 95.55 (Bandarkoot ) to Km. 111.06 (Chattroo) of 15.52 Km length on Khellani – Kishtwar –Chattroo section on NH-244 in the Union Territory of Jammu & Kashmir on EPC mode (Pkg –V).]**

1. The National Highways & Infrastructure Development Corporation Limited (the ‘NHIDCL’) invites proposals from eligible Consultants for engaging an Authority’s Engineer (AE) on the basis of National Competitive Bidding for the following contract package in the UT of Jammu & Kashmir.

TABLE 1: DETAILS OF PROJECT

S. N.	Consultancy Package	NH No.	State/ UT	Project Stretch	Project Length (Km)/ Project Cost(Cr.)	Assignment period (months)
1	[CONSULTANCY SERVICES AS AUTHORITY’S ENGINEER FOR SUPERVISION OF (I) Construction & Upgradation to 2 lane with paved shoulder from Design Km. 67.805 (at the end of Km 83rd tunnel near Dhrabshala) to Km 80.675 (Dulhasti) of 12.87 Km length on Khellani – Kishtwar –Chattroo section of NH-244 in the Union Territory of Jammu & Kashmir on EPC mode (Pkg –III). & (II) Construction of Kishtwar bypass with 2 lane with paved shoulder from Design Km. 80.675 (Dulhasti) to Km 95.550 (bandarkoot ) of 14.88 Km length on Khellani – Kishtwar –Chattroo section and a link road to Kishtwar town of 1.871 km on NH-244 in the Union Territory of Jammu & Kashmir on EPC mode (Pkg –IV). & (III) Construction /Up gradation 2 lane with paved shoulder from Design Km 95.55 (Bandarkoot ) to Km. 111.06 (Chattroo) of 15.52 Km length on Khellani – Kishtwar –Chattroo section on NH-244 in the Union Territory of Jammu & Kashmir on EPC mode (Pkg –V).]	[.....NH-244.....]	[...Jammu & kashmir.....]	[Chenani-Shudhmahadev-Goha-Khellani-Khanabal	45.14km/ Rs.821.15 Cr excl. GST	[24] months during Construction Period and [60] months during Maintenance Period

2. **The RFP has also been uploaded on “INFRACON” (www.infracon.nic.in).** As such before submitting the proposal the Consultant shall mandatorily register and enlist themselves (the firm and all key personnel), on the MoRTH portal “INFRACON” and furnish registration details along with its RFP. A copy of Infracon Operation Procedure is also enclosed for bidder’s reference.
3. **All the bidders registered on Infracon shall form a Team on Infracon and which would be assigned unique Infracon Team ID. Bidders while submitting the proposal shall quote the Infracon Team ID.**

4. Bid must be submitted online at e-tender portal of NHIDCL, <https://eprocure.gov.in> on or before **[28/07/2021]** at [11:00] hrs. The complete BID document can be viewed / downloaded from [www.eprocure.gov.in](http://www.eprocure.gov.in) and can be viewed on official portal of NHIDCL <http://www.nhidcl.com>.
5. Selection of AE shall be as per selection procedures given in the Contract Agreement for Engineering Procurement and Construction. The selected AE shall be intimated to the Contractor.
6. The proposal shall be submitted in English Language and all correspondence would be in the same language.
7. National Highways & Infrastructure Development Corporation Limited (NHIDCL) intends to appoint a Consultant to act as Authority's Engineer for implementation of the EPC project. As per the Terms and Conditions of the EPC Agreement (s), the Authority's Engineer shall perform all the duties as per TOR given in this RFP along with any amendment thereof. The selection of Authority's Engineer shall follow the laid down procedures given in the Contract Agreement signed between NHIDCL and Contractor. The Civil work is to be executed in the following 02 packages:

Sl. No.	Package Name, No. & NH No.	Length (in Km)	Awarded Civil Cost excl. GST (Rs. in Cr)	Completion Time
1	Construction & Upgradation to 2 lane with paved shoulder from Design Km. 67.805 (at the end of Km 83rd tunnel near Dhrabshala) to Km 80.675 (Dulhasti) of 12.87 Km length on Khellani – Kishtwar –Chattroo section of NH-244 in the Union Territory of Jammu & Kashmir on EPC mode (P –III).	12.87	134.35	18 Months
2	Construction of Kishtwar bypass with 2 lane with paved shoulder from Design Km. 80.675 (Dulhasti) to Km 95.550 (bandarkoot ) of 14.88 Km length on Khellani – Kishtwar – Chattroo section and a link road to Kishtwar town of 1.871 km on NH-244 in the Union Territory of Jammu & Kashmir on EPC mode (P–IV).	16.75	441.19	24 Months
3.	Construction /Up gradation 2 lane with paved shoulder from Design Km 95.55 (Bandarkoot ) to Km. 111.06 (Chattroo) of 15.52 Km length on Khellani – Kishtwar –Chattroo section on NH-244 in the Union Territory of Jammu & Kashmir on EPC mode (Pkg –V).	15.52	245.61	18 Months
Total		45.14	821.15	

8. The interested consultancy firms may download the RFP document from the official website of the NHIDCL w.e.f. **[29/06/2021] to [28/07/2021] up-to [11:00]** hrs. The Bidders shall deposit the cost of RFP document of Rs. 5,900/- (Non Refundable) including GST online (RTGS/NEFT/Other online mode) to the NHIDCL's Bank account as specified in Datasheet. A copy of payment receipt (RTGS/NEFT/Other online mode) must be submitted. The RFP will be invited through e-tendering portal. Refer Procedure under e-tendering for submission of RFP through e-tendering.
9. Unqualified bidders would be informed regarding their non-qualification, without any explanation.

10. The proposal should be submitted by consultancy firms in two parts. The two parts of the proposal are **Part1: Technical Proposal** and **Part2: Financial Proposal**. For a given EPC Project, Stage -1 of the Evaluation shall consider the evaluation of the Technical Proposal (i.e. Part 1). The firms scoring the qualifying marks (minimum 75%) as mentioned in RFP shall only be considered for further evaluation. Under stage 2, the financial proposal of such firms as selected above shall be opened and evaluated. Proposals will finally be ranked according to their combined technical and financial scores as specified in clause 5 of section 2.
11. The total time period for the assignment as Authority's Engineer will be for Construction Period of [24] Months + Maintenance Period of [60] Months with reduced man power.
12. Consultants may apply either as a sole firm or forming Joint Venture with other consultants. In case of Joint Venture, the maximum number of Joint Venture partners is limited to 2 (i.e. one lead + 1 JV partners). Formulation of more than one JV/association with different partners for the same work is not allowed and all such proposal involving the firms shall be treated as non-responsive. If the Consultant submits bids as sole applicant and also in JV/Association with another consultant, both bids shall be summarily rejected. No Consultant shall submit more than one bid.
13. (A) The Applicant whether a sole applicant or lead member with joint venture may include one number of Associate to provide technology in assignment (refer Para 10 (iii) of data sheet). The Associate firm can provide equipment based road inspection services for any of the 4 equipment viz., (i) Network Survey Vehicle including all modules required as per technical specifications, (ii) Falling Weight Deflectometer, (iii) Mobile Bridge Inspection Unit and (iv) Retro Reflectometer. However, the Associate(s) cannot be common for 2 or more bidders. If any Associate is common with 2 or more bidders, all those bids shall be declared non-responsive. Hence, the bidder may ensure on his own that the associate proposed by him is not proposed by any other bidder participating in the same assignment and the bidder is solely responsible in this regard.  
  
(B) In addition, the applicant whether a sole applicant or lead member with joint venture may also include an Associate for providing key personnel. In such case, the applicant should submit an MOU with associate regarding role and responsibility of Associate Company. However, the maximum no. of key personnel from Associate firm during RFP proposal and implementation of contract should be limited to two (2).
14. The Applicant, by submitting its Application pursuant to this RFP, shall be deemed to have acknowledged that without prejudice to the NHIDCL any other right or remedy hereunder or in law or otherwise, the Applicant shall be debarred from participating in the future projects of the NHIDCL in the following situations:
  - (a) If an Applicant withdraws its Proposal during the period of its validity as specified in this RFP and as extended by the Applicant from time to time.
  - (b) In the case of a Selected Applicant, if the Applicant fails to sign the Agreement.
15. Consulting firms meeting the following criteria are only eligible for applying for this assignment. Firms not meeting these criteria need not apply.

NOTE The construction period to be indicated in the RFP by concerned Technical Division inviting the RFP.

**A). Eligibility criteria for sole applicant firm**

S. No.	Experience of the firm in last 7 Years		Annual Turnover***
	Preparation of DPR (NH/SH/Equivalent)	Project Supervision/IC (NH/SH/Equivalent)	
1 (a).	The firm should have minimum experience of preparation of detailed Project Report/ Feasibility Study cum Preliminary Design Report of 2/4/6**- laning/Bridge project of aggregate length equal to 2 times or more of similar category for which RFP is invited i.e. [90.28] km	The firm should have minimum experience of Project Supervision/ Independent Engineer/ Consultant of 2/4/6**- laning/Bridge project of aggregate length equal to 3 times or more of similar category** for which RFP is invited i.e. [135.42] km	Annual turnover (updated average of last 3 years) of the firm from consultancy business should be equal to or more than 2% of Estimated Project Cost i.e. [17.09] cr.
1 (b)		Firm should also have experience of Project Supervision/ Independent Engineer/ Authority's Engineer of at least one project of similar category of two/four/six** laning/bridge work of length equal to 40% of project length i.e. [18.06] km	

\*\* Similar project means 2/4/6 lane as applicable for the project for which RFP is invited. For 2-lane projects experience of 4/6 lane also to be considered with a multiplication factor of 1.5. Experience of 4/6 lane shall be considered interchangeably for 4/6 laning projects. For 4/6 laning projects, experience of 2 lane will be considered with a multiplication factor of 0.4, but only for those 2 lane projects whose cost of consultancy services was more than Rs.3.0 crores.

**B) Eligibility Criteria for partners in case of JV (not more than 1 JV partners shall be allowed) shall be as under:**

The lead partner must fulfill at least 50% of requirements at 1(a) of table in Para (A) above and other JV partner should fulfill at least 30% of eligibility criteria as indicated at 1(a) of table in Para (A) above. Also The lead partner and JV partner should jointly also meet the eligibility criteria as mentioned at 1(a) of table in Para (A) above. Lead partner should also meet the criteria 1 (b) of table in Para (A) above.

**Note:** The weightage given for experience of a firm would depend on the role of the firm in the respective assignments. The firm's experience would get full credit if it was the sole firm in the respective assignment. If the applicant firm has completed projects as JV with some other firms, weightage shall be given as per the JV

share\*\*\*. However if the applicant firm has executed the project as associate with some other firms, 25% weightage shall be given to the applicant firm for the projects completed under such association

\*\*\* For weightage of experience in any past Consultancy assignment, experience certificate from the client shall be submitted. **In absence of clear demarcation of JV share in client certificate, the weightage will be treated as 60 % for lead partner and 40% for minor partner.** Annual turnover duly certified by Chartered Accountant shall be accepted. In case of non-availability of such documents no weightage of turnover/experience will be considered.

16. In case the financial figures and values of services provided are in foreign currency current market exchange rate (State Bank of India BC Selling rate as on last date of submission of the bid) will be applied for the purpose of conversion of amount in foreign currency into Indian Rupees.
17. The Bidder including individual or any of its Joint Venture Member should, in the last 2 years, have neither failed to perform for the consultancy services pertaining to Expressways, National Highways, ISC (Inter State Connectivity) & EI (Economic Importance) works, as evidenced by imposition of a penalty by an arbitral or judicial authority or a judicial pronouncement or arbitration award against the Bidder including individual or any of its Joint Venture Member, as the case may be, nor has been expelled or terminated by Ministry of Road Transport & Highways or its implementing agencies for breach by such Bidder including individual or any of its Joint Venture Member. Consultants (sole firm or lead firm and any of the JV partners) who do not fulfill the aforesaid condition as on last date of submission of proposal, need not apply as their RFP proposal will not be entertained.
18. NHIDCL will not be responsible for any delay, loss or non-receipt of RFP document sent by post/courier. Further, NHIDCL shall not be responsible for any delay in receiving the proposal and reserves the right to accept/reject any or all applications without assigning any reason thereof.
19. The two parts of the Proposal (Technical proposal and Financial proposal) must be submitted on-line only with all pages numbered serially, along with an index of submission as per procedure under e-tendering. Physical submission of the proposal shall not be accepted. In the event, any of the instructions mentioned herein have not been adhered to, the NHIDCL may reject the Proposal.
20. NHIDCL will be at liberty to keep the credentials submitted by the Consultants at bidding stage, in public domain and the same may be uploaded by NHIDCL on NHIDCL's web-site. Consultants should have no objection if NHIDCL uploads the information pertaining to their credentials as well as of their key personnel.
21. The individual key personnel proposed in the bid by the consultants or any replacement thereof should undertake that they shall have no objection in uploading/hoisting of their credentials by NHIDCL in public domain.
22. RFP submission must be received not later than [11/00] Hrs on [28/07/2021] in the manner specified in the RFP document at the address given below

**Address of NHIDCL:**

**ATTENTION**

**SHRI [B.Shivprasad]**

**DESIGNATION**

**[General Manager(Tech)]**

**ADDRESS**

**2<sup>nd</sup> FLOOR, PTI BUILDING, 4-PARLIAMENT**

STREET, NEW DELHI.

CONTACT

011-23461674

EMAIL ID

[Shivprasad.152p@gov.in  
]

**C) Criteria for Ineligibility to bid:**

24. Stands debarred by the Authority as a natural consequence of termination of any Consultancy Contract of Authority.
24. Has been placed in the Negative list of the firms by the Authority for any reason including failure to deliver consultancy in time bound manner, abandoning the project without permission of the Authority, non mobilization of key personnel, poor performance, penalties, missing commitments, non-adherence to quality specifications, inefficient supervision of works, unethical practices, failure to abide by Integrity Pact or failure to follow any lawful directions given by the Authority.
25. The bidder including individual or any of its JV members or its related parties, who are already having three or more on-going Authority's Engineer Consultancy contract(s) in NHIDCL, as on date of financial bid opening, shall not be eligible to bid for this project.

**Explanation :**

- (i) An LOA issued for any project shall be counted as an on-going project.
- (ii) Projects with consultancy fee of Rs. 1.5 Crores or less shall not be counted for this purpose.
- (iii) In case of a company, the Related Parties means Related Parties as defined in the Companies Act' 2013, and in case of a bidder other than a company, the Related Parties means bodies in which the bidder or its partners are partner, trustee or directors in other bodies whether incorporated or not.

To substantiate this, the bidder shall provide an undertaking giving list of all such Related Parties and projects being executed by the Related Parties in NHIDCL.

A certificate in this regard from Statutory Auditor (with UDIN) shall also be provided by the bidder.

## SECTION 2: LETTER OF INVITATION TO CONSULTANTS

### 1. INTRODUCTION

- 1.1 Bids are invited from consulting firms either as a sole firm/ joint venture with other Consultant willing to act as AE to submit a proposal for providing consulting services required for the assignment Consultancy services for [CONSULTANCY SERVICES AS AUTHORITY'S ENGINEER FOR SUPERVISION OF(I) Construction & Upgradation to 2 lane with paved shoulder from Design Km. 67.805 (at the end of Km 83rd tunnel near Dhrabshala) to Km 80.675 (Dulhasti) of 12.87 Km length on Khellani – Kishtwar –Chattroo section of NH-244 in the Union Territory of Jammu & Kashmir on EPC mode (Pkg –III). &(II) Construction of Kishtwar bypass with 2 lane with paved shoulder from Design Km. 80.675 (Dulhasti) to Km 95.550 (bandarkoot ) of 14.88 Km length on Khellani – Kishtwar –Chattroo section and a link road to Kishtwar town of 1.871 km on NH-244 in the Union Territory of Jammu & Kashmir on EPC mode (Pkg –IV). &(III) Construction /Up gradation 2 lane with paved shoulder from Design Km 95.55 (Bandarkoot ) to Km. 111.06 (Chattroo) of 15.52 Km length on Khellani – Kishtwar –Chattroo section on NH-244 in the Union Territory of Jammu & Kashmir on EPC mode (Pkg –V).]
- 1.2 A brief description of the assignment and its objectives are given in the Terms of Reference (TOR).
- 1.3 The assignment shall be implemented in Construction Period (24 Months) and Maintenance Period (60 Months).
- 1.4 This RFP is neither an agreement nor an offer by the NHIDCL to the prospective Applicants or any other person. The purpose of this RFP is to provide interested parties with information that may be useful to them in the formulation of their Proposals pursuant to this RFP. This RFP includes statements and assumptions, which reflect various assessments arrived at by the NHIDCL in relation to the Consultancy. Such assessments and statements do not purport to contain all the information that each Applicant may require. The information contained in this RFP, may not be complete, accurate, adequate or correct. Each Applicant should, therefore, conduct its own investigations about the assignment and the local conditions before submitting the proposal by paying a visit to the NHIDCL and the project site, sending written queries to the NHIDCL, before the date and time specified in the Data Sheet.
- 1.5 Please note that (i) the costs of preparing the proposal and negotiating for the contract, including a visit to site, are not reimbursable as a direct cost of assignment and (ii) NHIDCL is not bound to accept any of the proposals received by it and reserves the right to annul the selection process at any time prior to contract award, without thereby incurring any liability to the Consultants
- 1.6 Consultant have an obligation to disclose any situation of actual or potential conflict that impacts their capacity to serve the best interest of NHIDCL, or that may reasonably be perceived as having this effect. Failure to disclose said situations may lead to the disqualification of the Consultant or the termination of its Contract and/or any other action as deemed fit by the NHIDCL at any stage
- 1.7 It is the NHIDCL policy that the consultants observe the highest standard of ethics during the selection and execution of such contracts. In pursuance of this policy, the NHIDCL:
  - (a) Defines, for the purpose of this paragraph, the terms set forth below as follows:
    - (i) “corrupt practice” means the offering, giving, receiving, or soliciting, directly or indirectly, of anything of value to influence the action of a public official in the selection process or in contract execution;

- (ii) “fraudulent practice” means a misrepresentation or omission of facts in order to influence a selection process or the execution of a contract;
- (iii) “collusive practices” means a scheme or arrangement between two or more consultants with or without the knowledge of the NHIDCL, designed to establish prices at artificial, non-competitive levels;
- (iv) “Coercive practices” means harming or threatening to harm, directly or indirectly, persons or their property to influence their participation in a procurement process, or affect the execution of a contract.

(b) will reject a proposal for award if it determines that the Consultant recommended for award has, directly or through an agent, engaged in corrupt, fraudulent, collusive or coercive practices in competing for the contract in question;

(c) will declare a firm ineligible, either indefinitely or for a stated period of time, to be awarded a contract if it at any time determines that the firm has engaged in corrupt or fraudulent practices in competing for, or in executing, a contract; and

(d) Will have the right to require that a provision be included requiring consultants to permit the NHIDCL to inspect their accounts and records relating to the performance of the contract and to have them audited by authorized representatives of NHIDCL.

1.8 Consultants, their JV partner, their Sub-Consultants, and their associates shall not be under a declaration of ineligibility for corrupt and fraudulent practices. Furthermore, the Consultants shall be aware of the provisions on fraud and corruption stated in the specific clauses in the General Conditions of Contract.

1.9 Consultants shall furnish information on commissions and gratuities, if any, paid or to be paid to agents relating to this proposal and during execution of the assignment if the Consultant is awarded the Contract, in the Financial Proposal.

1.10 The Data Sheet indicates how long Consultants’ Proposals must remain valid after the submission date. During this period, Consultants shall maintain the availability of Professional staff nominated in the Proposal. The NHIDCL will make its best effort to complete the process within this period. Should the need arise, however, the NHIDCL may request Consultants to extend the validity period of their proposals. Consultants who agree to such extension shall confirm that they maintain the availability of the Professional staff nominated in the Proposal, or in their confirmation of extension of validity of the Proposal, consultants could seek replacement upto a maximum of 50% key personnel .If any Consultant seeks any replacement(s), while extending the bid validity, then the same shall be evaluated for ascertaining suitability of replacement as per the provisions of the RFP and remuneration shall not be reduced for any such replacement(s). However, the technical evaluation shall take into account of the originally submitted CV(s) only irrespective of replacement sought.

1.11 Only Indian firms are allowed to participate in the bid and no International Bidder is eligible as individually or as a member of a Joint Venture or as an associate.

## **2. CLARIFICATIONS AND AMENDMENT OF RFP DOCUMENTS**

**2.1** The Consultants may request a clarification of any of the RFP documents up to the number of days indicated in the Data Sheet before the Proposal submission date. Any request for clarification must be sent in writing by paper mail, facsimile, or electronic mail to the NHIDCL's address indicated in the Data Sheet. The NHIDCL will respond by cable, facsimile, or electronic mail to such requests and will send copies of the response (including an explanation of the query but without identifying the source of inquiry) to all consultants who have purchased the RFP document. Clarification/amendment will also be hosted on NHIDCL e-portal.

**2.2** At any time before the submission of Proposals, NHIDCL may for any reason, whether at its own initiative or in response to a clarification requested by a Consulting firm, modify the RFP documents by amendment. Any amendment shall be issued in writing through addendum. Addendum may be sent by mail, cable, telex, facsimile or electronic mail to consultants or/and will be hosted on NHIDCL's website which will be binding on them. NHIDCL may at its discretion extend the deadline for the submission of Proposals.

**3. PREPARATION OF PROPOSAL**

**3.1** Consultants are requested to submit their proposal online in Two Parts strictly using the formats enclosed herewith (refer section 3,4and 5). The two parts shall be:

**Part 1: Technical Proposal**

**and**

**Part 2: Financial Proposal.**

The proposal shall be written in the English language as specified in the Data Sheet. All pages of the Proposal shall be signed by an authorized representative. The representative's authorization shall be confirmed by written Power of Attorney duly notarized to be submitted with the proposal. In case of JV or inclusion of Associate company, a MoU indicating the specific Projects, input and role of each Partner etc. shall be submitted with the proposal.

**Part 1: Technical Proposal**

**3.2** Consultants are expected to examine all terms and conditions included in the documents. Failure to act or to provide all requested information will be at their own risk and may result in rejection of your proposal.

**3.3** During preparation of the Technical proposal you may give particular attention to the following:

i. The man-months for the assignment shall be that stated in the Terms of Reference. The same shall be considered for the purpose of evaluation as well as award. In case the man months of TOR are amended in view of NHIDCL's own initiative or in response to clarification sought by any Consulting firm, the man months so amended and published shall be considered for the purpose of evaluation as well as award.

ii. The Consultants should prefer to field as many of their permanent staff as possible. The permanent staff would be considered those already employed with the firm prior to one year from the month

during which this Tender Notice is issued. Applicant shall submit the details of the period of employment of the proposed personnel with the firm.

- iii. A good working knowledge of the language specified in the data sheet is essential for key professional staff on this assignment. Reports must be in the language (s) specified in the data sheet.

**3.4** The Technical Proposal must provide the following information, using but not limited to the formats attached in the Section 3 & 4.

- i. A brief description of the firm's organization and an outline of recent experience of the Consultants and, in the case of Joint Venture, for each partner, on assignments of a similar nature. The information which consultants shall provide on each assignment should indicate, inter-alia, the profiles of the staff provided, duration, contract amount and firm's involvement. **The details of assignments on hand shall also be furnished by the Consultant and their JV partner, separately.**
- ii. Proposed methodology for the execution of the services illustrated with bar charts of activities, including any change proposed in the methodology of services indicated in the TOR, and procedure for quality assurance: Maximum 4 pages.
- iii. Site Appreciation: limited to four A4 size pages in 1.5 space and 12 font including photographs, if any;
- iv. Any comments or suggestions on the ToR and a description of the methodology (work plan) which the firm proposes to execute the services should be illustrated with bar charts of activities;
- v. The proposed methodology should be accompanied by the consultant's initial view, key challenges they foresee and potential solutions. It should also include details on adoption of superior technology along with proof: limited to six A4 size pages in 1.5 space and 12 font including photographs;
- vi. The proposal shall indicate as to whether the firm is having the facilities for carrying out the following field activities or these are proposed to be outsourced to specialized agencies.
  - Surface defects detection and roughness measurement using Network Survey Vehicle.
  - Pavement strength measurement using FWD.
  - Bridge inspection using Mobile Bridge Inspection Unit.
  - Road signs inspection using Retro Reflectometer.
- vii. Proposed Quality Audit Methodology including Quality Assurance Plan.
- viii. In case the Consultant envisages outsourcing any or all of the above services to the expert agencies, the details of the same indicating the arrangement made with the agencies need to be furnished. These agencies would however, be subject to approval of NHIDCL to ensure quality input by such agencies before award of the work. For out-sourced services, proposed firms/consultants should have such experience on similar projects.
- ix. The composition of the proposed staff team, the tasks which shall be assigned to each and their timing;
- x. Requirement for submission of CVs.
  - a. The CVs of following [Six key personnel in the format as per Appendix- B-6 is to be furnished on

INFRACON portal.

[Team leader cum Senior Bridge Engineer, Resident cum Highway Engineer, Bridge/Structural Engineer, Senior Quality cum Material Expert , Sr. Contract Specialist , Road Safety Expert in case of Normal Highway Project]

It may please be ensured that the format is strictly followed and the information furnished therein is true and correct. The CV must indicate the work in hand and the duration till which the person will be required to be engaged in that assignment. The Firm shall ensure that details furnished in the CV by the personnel are correct. If any information is found incorrect, at any stage, action including termination and debarment from future NHIDCL projects for a minimum period of 2 years may be taken by NHIDCL on the personnel and the Firm. If any information is found incorrect/fake/inflated in the CV, at any stage, debarment of the key personnel from future NHIDCL projects up-to 2 years may be taken by NHIDCL.

- b. Key information should include years with the firm and degree of responsibility held in various assignments. In CV format, at summary, the individual shall declare his qualification & total experience (in years) against the requirements specified in TOR for the position (Ref. Enclosure-B of TOR). In case, the information contained in the CV for the duration in which the key personnel was employed by the firm, proposing his candidature is found incorrect/fake/inflated, at any stage, action including termination of the consultancy agreement and debarment of the firm upto 2 years from future NHIDCL projects shall be taken by NHIDCL.
- c. CVs of Key Personnel having intermittent inputs will be considered only if the assignments on hand as on 7 days before due date of proposal including those for which LOA has been received from NHIDCL or for which Consultant has been declared as H1 are such that the key personnel is able to proportionately devote the given man months for this project. In case, the information contained in the CV for the duration in which the key personnel was employed by the firm proposing his candidature is found incorrect/fake/inflated at any stage, the consultancy firms shall have to refund the salary and perks drawn in respect of the person apart from other consequences.
- d. All the CVs which are to be evaluated should be complete in all respects including signing and certification by the individual and the firm.
- e. Minimum 75% marks required. CV of [six/seven] Key Personnel will be evaluated CV of proposed Team Leader should score at least 75% marks. If not, the proposal shall not be considered further.
- f. If a CV score less than 75% marks, whatever marks it score will be carried forward for maximum 3 nos. key personnel for determining the total score of the firm. However, if the Key Personnel does not fulfill the minimum academic qualification (as mentioned at Enclosure-B of TOR of RFP), the overall score of his CV will be evaluated as zero. If the Key Personnel does not fulfill the minimum qualification related to experience (as mentioned at Enclosure-B of TOR of RFP), then zero marks will only be assigned for that sub criteria, but the marks obtained by the CV of the Key Personnel will be carried forward for maximum 3 nos. key personnel for determining the total score of the firm. In case, a firm is H-1, then all such Key Personnel (whose CV scores less than 75% or who does not fulfill the minimum qualification) will have to be replaced by the firm before signing the contract. The reduction in remuneration of such replacements shall be 10%

for each replacement. In case more than 3 CV scores less than 75% marks or Team leader cum Senior Highway Engineer scores less than 75% marks, the proposal shall be considered non-responsive.

- g. If any case of fake/incorrect/inflated CV is found, it shall be dealt with very severely and would result in all possible penal action including blacklisting from future projects of NHIDCL. This would also apply even when the consulting firm is not successful in getting the assignment. In case , the information contained in the CV for the duration in which the key personnel was not employed by the firm proposing his candidature is found incorrect/Fake/inflated at any stage , the consultancy firms will have to refund the twice of salary and perks drawn in respect of the person.
- h. It is also clarified that any key personnel, if debarred during the period between receipt of bid and award of the contract and is required to be replaced as per the provisions of the RFP, then the replacement shall not be considered as part of replacement by the Authority's Engineer and hence no deduction in remuneration shall be affected. However, in this case the original CV will be considered for evaluation purpose.

- xi Deployment Schedule for each key personnel should be formulated and incorporated in the Technical Proposal which will be reviewed on quarterly basis.
- xii. Estimates of the total time effort (person x months) to be provided for the services, supported by bar chart diagrams showing the time proposed (person x months) for each professional staff and sub professional staff.
- xiii. In case, consultant Firm's experience/ document is found to be false at any stage i.e. from bidding to completion of services, the Consultancy contract shall be terminated and consultant firm shall be debarred for a period of 2 years.

**3.5** The technical proposal must NOT include any financial information.

## **Part 2: Financial Proposal**

**3.6** Your Financial Proposal must be strictly using the formats attached in Section 5. No additional items/quantities other than that specified in the formats should be proposed by the Consultants since the same shall not be considered for the evaluation/award. Consultants shall be paid billing rates for services as per financial proposal submitted by them basis. Beginning 13th months from the last date of submission of bid, billing rates shall be increased to cover all items of the contract i.e. remuneration, vehicle hire, office rent, consumables, furniture etc. @ 5% every 12 months. However, for evaluation and award of the Bid proposals, the quoted initial rate (as applicable for first 12 months from last date of submission of bid) shall be multiplied by the total time input for each position on this contract, i.e. without considering the increase in the billing rates. All payments shall be made in Indian Rupees and shall be subjected to applicable Indian laws withholding taxes if any.

**3.7** The Financial Proposal should clearly identify as a separate amount, the local taxes (including social security), duties, fees, levies and other charges imposed under the applicable law, on the consultants, the sub-consultants, and their personnel (other than nationals or permanent residents of the government's

country); unless the Data Sheet specifies otherwise. This cost, however, will not be considered in evaluation.

**3.8** Consultants may express the price of their services in the Indian Rupees only.

**3.9** Goods & Service tax as applicable shall be paid to the Consultant while making payment for services rendered. The consultants shall then deposit the same with the tax authorities and provide a proof of having done so within next 90 days in line with policy circulars issued by NHIDCL. NHIDCL shall pay only the Goods & service tax.

#### **4. SUBMISSION, RECEIPT AND OPENING OF PROPOSALS**

##### **4.1 PREPARATION & SUBMISSION OF APPLICATIONS**

A. Detailed RFP may be downloaded from E-tendering portal of NHIDCL and the Application may be submitted online following the instructions appearing on the screen.

B. The following shall be the form of various documents in the Application:

I. **Technical Proposal {Only Electronic Form (to be uploaded on the E- tendering portal of NHIDCL)}**

- (a) Power of Attorney for signing the Application
- (b) If applicable, the Power of Attorney for Lead Member of JV;
- (c) Copy of Memorandum of Understanding between JV partners, if applicable;
- (d) Copy of Memorandum of Understanding with Associate, if applicable.
- (e) Firms credentials as per format prescribed in SECTION-3 OF RFP. (The details are to be submitted through INFRACON only)
- (f) Technical proposal as per format prescribed in SECTION-4 OF RFP. (The details are to be submitted through INFRACON only.)

II. **Financial proposal as per format prescribed in section – 5 of RFP**

III. **NEFT/IMPS/RTGS towards cost of RFP of Rs.5,000/- +GST @ 18 % i.e. Rs. 5900/- in in favour of NHIDCL**

IV. Bidders have to comply with the OM No. 13030/09/2008-vig dated 28th January, 2013(copy enclosed) regarding Integrity pact.

C. The successful bidder shall submit the original documents specified above in point no.4.1 B (I) (a), (b), (c)& (d) above together with their respective enclosures to NHIDCL before signing of the Agreement.

- i. The Applicant shall upload scanned copies of the Technical Proposal and Financial Proposal as specified in point nos. 4.1 (B) (I),(II), (III) & (IV) above on the E- tendering portal of NHIDCL on the Application due date. Financial Proposal is to be submitted On-line only and no hard submission is to be made.

#### 4.2 **Modification / Substitution/ Withdrawal of bids:**

- (i) The Bidder may modify, substitute or withdraw its e- bid, prior to the Bid Due Date. No Bid shall be modified, substituted or withdrawn by the Bidder on or after the Bid Due Date.
- (ii) Any alteration/ modification in the Bid or additional information supplied subsequent to the Bid Due Date, unless the same has been expressly sought for by the NHIDCL, shall be disregarded.
- (iii) For modification of e-bid, bidder has to detach its old bid from e-tendering portal and upload / resubmit digitally signed modified bid.
- (iv) For withdrawal of bid, bidder has to click on withdrawal icon at e-tendering portal and can withdraw its e-bid.
- (v) Before withdrawal of a bid, it may specifically be noted that after withdrawal of a bid for any reason, bidder cannot re-submit e-bid again.

#### 4.3 **OPENING AND EVALUATION OF APPLICATIONS:**

- (i) Opening of Proposals will be done through online for both Financial Proposal and Technical Proposal.
- (ii) For participating in the tender, the authorized signatory holding Power of Attorney shall be the Digital Signatory. In case the authorized signatory holding Power of Attorney and Digital Signatory are not the same, the bid shall be considered non- responsive.

The NHIDCL will open the Technical Proposal in the presence of the Applicants who choose to attend and evaluate the Applications in accordance with the provisions set out in the RFP.

- (iii) The Financial Proposal will be opened of the short listed applicants only who qualify for financial opening as per RFP. The date of opening of Financial Proposal will be notified later on

### 5. **PROPOSAL EVALUATION**

5.1 A two -stage procedure shall be adopted for evaluating the proposals.

5.2 Deleted

#### **Technical Proposal**

- 5.3 The Evaluation Committee appointed by the NHIDCL shall carry out its evaluation applying the evaluation criteria and point system specified in the data sheet. Each responsive proposal shall be attributed a technical score (ST.) Only those Applicants whose Technical proposal score 75 marks or more out of 100 shall qualify for further consideration. However, if the number of such pre-qualified applications is less than two, the NHIDCL may, in its sole discretion, pre-qualify the applicant(s) whose technical score is less than 75 marks.

#### **Financial Proposal**

- 5.4 After the evaluation of Technical Proposals is completed and the shortlist of firms is finalized, the NHIDCL may notify those consultants whose proposals were not considered as per conditions of RFP. The NHIDCL shall simultaneously notify the shortlisted firms indicating the date and time set for opening of the Financial Proposals.
- 5.5 The Financial Proposals shall be opened publicly in the presence of the consultants' representatives who choose to attend. The name of the consultant, the technical scores, and the proposed prices shall be read aloud and recorded when the Financial Proposals are opened. NHIDCL shall prepare minutes of the public opening.
- 5.6 The Evaluation Committee will determine whether the submitted Financial Proposals are complete (i.e. whether they have included cost of all items of the corresponding proposals; if not, then the cost towards such missing items will be considered as NIL, but the Consultant shall, however, be required to carry out such obligations without any additional compensation.) and without computational error. In case under such circumstances, if NHIDCL feels that the work cannot be carried out within the overall cost as per the submitted financial proposal, such proposals shall be considered non responsive.
- 5.7 The lowest financial proposal (FM) will be given a financial score (SF) of 100 points. The financial scores of other proposals will be computed as follows:

$$S_F = 100 \times F_M / F \text{ (F= amount of financial proposal)}$$

- 5.8 Proposals will finally be ranked according to their combined technical (ST) and financial (SF) scores as follows:

$$S = S_T \times T_w + S_F \times F_w$$

Where S is the combined score, and Tw and Fw are weights assigned to Technical Proposal and Financial Proposal that shall be 0.70 and 0.30 respectively.

- 5.9 The selected Authority's Engineer shall be the first Ranked Applicant (H-1, having the highest combined score). In the event the proposals of two or more consultants have the same scores in the final ranking, the proposal with the highest technical score should be ranked first.

## **6. AWARD OF CONTRACT**

- 6.1 NHIDCL shall issue letter of award to selected Consultant and ask the Consultant to provide Performance Security as in Para 7 below. If the selected Consultant fails to provide performance security within the prescribed time or the Consultant fail to sign the Contract Agreement within prescribed time, NHIDCL may invite the 2<sup>nd</sup> highest ranking bidder Consultant and follow the procedure outlined in Para 6 and 8 of this Letter of Invitation.

## **7. PERFORMANCE SECURITY**

7.1 The successful consulting firm shall have to submit a Bank Guarantee (BG) for an amount of 5% of the Contract Value within 15 days of issue of LOA. The BG shall be valid for a period of [84+2] i.e. upto 2 months beyond the expiry of the Contract period of [84 Months]. The BG shall be in the format specified in Appendix H of draft contract form and furnished from Public Sector Banks or Scheduled Private Banks having the Net Worth of Rs 1,000/- crores or more as per the latest annual report of the bank, in favour of the Authority. The list of such banks is

mentioned as below. The Authority reserves the right to add or remove any of names bank on which BG shall be accepted based on advisories from the Govt./RBI. The BGs issued by 'Foreign Banks' and Banks not mentioned in the given list shall not be accepted. In case of JV, the BG shall be furnished on behalf of the JV and not individually by the members.

List of Public Sector Banks	List of Scheduled Private Sector Banks
1. Bank of Baroda	1. Axis Bank Ltd.
2. Bank of India	2. Bandhan Bank Ltd.
3. Bank of Maharashtra	3. CSB Bank Ltd.
4. Canara Bank	4. City Union Bank Ltd.
5. Central Bank of India	5. DCB Bank Ltd.
6. Indian Bank	6. Federal Bank Ltd.
7. Indian Overseas Bank	7. HDFC Bank Ltd.
8. Punjab National Bank	8. ICICI Bank Ltd.
9. Punjab & Sind Bank	9. Indusind Bank Ltd.
10. State Bank of India	10. IDFC First Bank Ltd.
11. UCO Bank	11. Jammu & Kashmir Bank Ltd.
12. Union Bank of India	12. Karnataka Bank Ltd.
	13. Karur Vysya Bank Ltd.
	14. Kotak Mahindra Bank Ltd.
	15. RBL Bank Ltd.
	16. South Indian Bank Ltd.
	17. Tamilnadu Mercantile Bank Ltd.
	18. IDBI Bank Ltd.

**7.1** In the event the Consultant fails to provide the security within 15 days of date of LOA, it may seek extension of time for a period of 15 (Fifteen) days on payment of damages for such extended period in a sum of calculated at the rate of 0.1% (Zero Point One Percent) of the contract price for each day until the performance security & APS is provided. For the avoidance of doubt the agreement shall be deemed to be terminated on expiry of additional 15 days time period.

**7.3** Notwithstanding anything to the contrary contained in this Agreement, the Parties agree that in the event of failure of the Consultant to provide the Performance Security in accordance with the provisions of Clause 7.1 within the time specified therein or such extended period as may be provided by NHIDCL, in accordance with the provisions of Clause 7.2 and thereupon all rights, privileges, claims and entitlements of the Consultant under or arising out of this Agreement shall be deemed to have been waived by, and to have ceased with the concurrence of the Consultant, and LoA shall be deemed to have been withdrawn by mutual agreement of the Parties. NHIDCL may take action to debar such firm for future projects for a period of 1-2 years.

## **8. Signing of Contract Agreement**

After having received the performance security and verified it, NHIDCL shall invite the selected bidder for signing of Contract Agreement on a date and time convenient to both parties within 15 days of receipt of valid Performance Security.

**DATA SHEET**  
**(As Mentioned in Letter of Invitation to Consultants)**

Sub clause No. in Letter of Invitation to Consultants

1. **Pre-Proposal Conference shall be held at:** NHIDCL Office, 3rd floor, PTI Building, 4-parliament Street, New Delhi-110001 on [14/07/2021] at [15:00] Hr. (No Physical meeting)
2. The proposal shall be valid for 120 days after the last date of submission.
3. Clarification may be requested 7 days prior to Pre Proposal Conference. The address for requesting clarification is:

<b>ATTENTION</b>	<b>SHRI [B.Shivprasad]</b>
<b>DESIGNATION</b>	<b>[General Manager(Tech)]</b>
<b>ADDRESS</b>	<b>2<sup>nd</sup> FLOOR, PTI BUILDING, 4-PARLIAMENT STREET, NEW DELHI.</b>
<b>CONTACT</b>	<b>011-23461674</b>
<b>EMAIL ID</b>	<b>[Shivprasad.152p@gov.in]</b>

4. The Language of documents and correspondence will be English.
5. All the personnel shall have working knowledge of English and all the reports etc shall be written in English.
6. NHIDCL shall reimburse only Goods and service tax. Authority's Engineer has to assess all other taxes and should inbuilt them in their financial proposal. These taxes (other than Goods and service tax) should not be provided separately. Consultants are requested to consult Tax Consultants for details.
7. The Consultants to ensure that their firms and key personnel should register their credentials / modules on [www.infracon.nic.in](http://www.infracon.nic.in) as stipulated in MoRT&H Circular No. RW-NH-35075/1/2010-S&R® dt. 28.10.2015.
8. The Consultants to state cost in INR.
9. The time and date of submission: Bid start date [21/07/2021] at [15/00] Hr
10. The points assigned to Technical Evaluation criteria are:

S. No.	Description	Marks
1	Relevant experience for the assignment	40
2	Experience in use of technology for road inspection	20
3	Qualifications and competence of the key staff for the assignment	40
	<b>Total</b>	<b>100</b>

**(i) Sub criteria for Relevant Experience of the firm for the assignment**

Average Annual Turnover (last 3 years) from consultancy business (Min 5crore)	2
No's of Highway Professionals with the firm * The professionals who possess degree in Civil Engineering/Transport Planning/Transport Economics/Traffic Management / Geology/ Environment Science or Engineering and 8 years experience in highway/bridge/tunnel with employment in the firm for more than one year. The current Employment Certificate shall be uploaded by Key Personnel on INFRACON.	10
Experience as Independent Engineer/Authority Engineer/Construction Supervision in Number of Highway Projects of length equal to 40% of project length of similar category for which RFP invited of 2/ 4/6**laning or more in last 7 years preceding bid submission date*	10
Experience in DPR preparation for Number of Highway Projects (of length 40% of project length of similar category for which RFP invited of 2/4/6**-laning or more) in last 7 years *	5
In hand DPRs for Authority (Ministry /NHAI/NHIDCL-As applicable) Projects (presently under progress)	10
Experience in Construction Supervision/DPR /Design Review of Major structure having length of more than 500 meter in last 7 years.	3

\* Consultants should give details of the experience of the firm considering the completed and the on-going highway assignments, separately for PPP and non-PPP Projects along with experience certificates from clients. This list of the completed works should also include those assignments which are substantially (90% of Contract value) completed. No Qualification/Experience etc. shall be considered without proof of experience.

Experience of Authority's Engineer for having offered consultancy services to a private organization shall not be considered as relevant experience for current assignment.

\*\* Similar projects means 2/4/6 lane as applicable for the project for which RFP is invited. For 2-lane projects, experience of 4/6 lane is also to be considered with a multiplication factor of 1.5. Experience of 4/6 lane shall be considered interchangeably for 4/6 laning projects. For 4/6 laning projects, experience of 2 lane will be considered with a multiplication factor of 0.4, but only for those 2 lane projects whose cost of consultancy services was more than Rs. 3.0 crores.

In case of JV the turnover and experience details of Lead and JV Employer's certificate should be submitted substantiating the experience claimed by the firm.

**(ii) Sub criteria for Experience in use of technology for road inspection**

Sr. No.	Description	Maximum Points	Sub-Points
1	<b>Experience in Network Survey Vehicle (NSV) or better technology for pavement inspection</b>	7	
1.1	<b>Equipment</b>	4	
	(a) Equipment on MOU with Associate or on hiring basis		2
	(b) Own Equipment		4
1.2	<b>Experience</b>	3	
	(a) 1-2 projects		1
	(b) 3-5 projects		2

	(c) >5projects		3
<b>2</b>	<b>Experience in Falling Weight Deflectometer (FWD) or better technology for pavement strength measurement</b>	<b>4</b>	
<b>2.1</b>	<b>Equipment</b>	<b>2</b>	
	(a) Equipment on MOU with Associate or on hiring basis		1
	(b) ) Own Equipment		2
<b>2.2</b>	<b>Experience</b>	<b>2</b>	
	(a) 1-3 projects		1
	(b) > 3 projects		2
<b>3</b>	<b>Experience in Mobile Bridge Inspection Unit or better technology for bridgeinspection</b>	<b>5</b>	
<b>3.1</b>	<b>Equipment</b>	<b>2</b>	
	(a) Equipment on MOU with Associate or on hiring basis		1
	(b) Own Equipment		2
<b>3.2</b>	<b>Experience</b>	<b>3</b>	
	(a) 1-2 projects		1
	(b) 3-5 projects		2
	(c) 5 projects		3
<b>4</b>	<b>Experience in Retro reflectometer technology</b>	<b>4</b>	
<b>4.1</b>	<b>Equipment</b>	<b>2</b>	
	a) Equipment on MOU with Associate or on hiring basis		1
	(b)Own Equipment		2
<b>4.2</b>	<b>Experience</b>	<b>2</b>	
	(a)1-3 projects		1
	(b)> 3 projects		2
	<b>Total</b>	<b>20</b>	

**Note: A.** The Authority's Engineer owning the equipments shall be required to submit proof of ownership.

**B.** The experience of the associate firms in use of technology shall also be counted in the evaluation. The experience of firm or associate firm in NSV or equivalent technology, FWD or equivalent technology, MBIU or equivalent technology and Retro Reflectometer or equivalent technology shall be supported by experience certificate. The experience of a firm/associate firm for a private concessionaire/contractor shall not be considered.

**C.** In case, Ownership document of equipment of Consultancy /Associate firm is found to be false,i0 The consultancy/ Associate firm, as the case may be, shall be put on holiday listing (temporary debarment ) for a period upto 12 months.

**(iii) Qualification and competence of following professional/sub-professional staff** for the assignment shall be evaluated. The weightage for various key staff are as under:-

**Normal Highway Project:**

<b>S.No</b>	<b>Staff Position</b>	<b>Marks.</b>
1	Team Leader Cum Senior Bridge Engineer	12
2	Resident cum Highway Engineer	6
3	Bridge/Structural Engineer	6
4	Senior Quality cum Material Expert	6
5	Senior Contract Specialist	6
6	Road Safety Expert	4
	<b>Total</b>	<b>40</b>

**Sub criteria for qualification of Key Personnel (i.e. Professional staff)**

General qualifications	25
Adequacy for the project	70
Employment with firm	5
Total	100

- (iv) The technical proposal should score at least 75 points to be considered responsive for financial evaluation.
- (v) Detailed evaluation criteria which is to be used for evaluation of technical bids is as indicated below as Appendix-EC.
- (vi) The Authority's Engineer should carryout self-evaluation based on the evaluation criteria at Appendix-EC. While submitting the self-evaluation along with bid, Authority's Engineer shall make references to the documents which has been relied upon in his self-evaluation.
- (vii) Result of technical evaluation shall be made available on the website giving opportunity to the bidders to respond within 7 days in case they have any objection.
- (viii) The single currency for price conversion is INR. For evaluation of bid proposals, the foreign currency conversation rate of 1US Dollar = [...]Rs. And 1 Euro = Rs. [...]Rs shall be used.  
(This will be the exchange rates as per Reserve Bank of India rounded off to nearest Rupee applicable at the time of RFP invitation).
- (ix) The weightage given to technical proposal is [70%.]  
The weightage given to financial proposal is [30%.]
11. Commencement of Assignment: The firm shall begin carrying out the services within one month of signing of the Consultancy Agreement.

**Remarks:** Based on experience and the Consulting Industry's Capacity, Project specific requirement etc., NHIDCL may modify the above criteria for Selection of AE.

**12** The NHIDCL's Bank Account detail is as given below: (REF. PARA 8 of NIT)

Sl No	Particulars	Details
1.	Name of Beneficiary	National Highways & Infrastructure Development Corporation Limited
2.	Beneficiary Bank Account No.	90621010002659
3.	Beneficiary Bank Branch Name and Address	Canara Bank, Transport Bhawan, 1st Parliament Street, New Delhi 110001
4.	Beneficiary Bank Branch IFSC	CNRB0019062

**Appendix-EC**

**1. Evaluation Criteria for Assessment of Experience of the Firm**

S.No.	Description	Max. Marks	Reference/Details of projects Claimed for self-assessment	Marks self-assessed by the bidder
1	Average Annual Turnover (last 3 years) from consultancy business < [17.09] – 0 marks  Add for additional turnover 0.25 (Zero point two five) marks for every Rs [8.55] above Rs. [8.55] Cr. subject to maximum 0.5 marks.	2		
2	Nos. of Highway Professionals with the firm *	10		
2.1	<10	0		
2.2	10-20	8		
2.3	>20 but ≤30	9		
2.4	>30	10		
<p><b>*The professionals who possess degree in Civil Engineering/Transport Planning /Transport Economics/Traffic Management / Geology/ Environment Science or Engineering and 8 years experience in highway/bridge /tunnel with employment in the firm for more than one year. The current Employment Certificate shall be uploaded by Key Personnel on INFRACON.</b></p>				
3	Experience as Independent Engineer/ Authority Engineer/ Construction Supervision in Number of Highway Projects of 2/4/6-laning** of length equal to [18.06] km or more in last 7 years. 1 project – 8 marks Add 1(one) mark extra for completed assignment of Authority Engineer/Independent Engineer and add 0.5 (Zero point five) marks extra for completed assignment of supervision consultancy subject to maximum 2 (Two) marks.	10		
4	Design Report preparation for Number of Highway Projects of 2/4/6-laning** of length (equal to [18.06] km or more in last 7 years. Experience in DPR/Feasibility Study cum Preliminary 1 project – 4 marks Add 0.5 (Zero point five) marks extra for each additional project subject to maximum 1 mark.	5		
5	In hand DPRs of Highway/Bridge/Tunnel Projects ( presently under progress)	10		
5.1	<2	0		
5.2	2-5	5		
5.3	>5	10		
6	Experience in Construction Supervision/DPR/Design Review of Major structures having length of more than 500 meter in last 7 years. 1 project – 2.0 marks Add 0.5 (Zero point five) marks extra for each additional project subject to maximum 1.0 marks	3		

Note 1: In case of JV the turnover and experience details of Lead and JV partners to be added.

Note 2: Employer's certificate/ certificate from Statutory Auditor should be submitted substantiating the experience/turnover claimed by the firm.

Note 3: \*\*For 4/6 laning projects, experience of 2 lane will be considered with a multiplication factor of 0.4, but only for those 2 lane projects whose cost of consultancy services was more than Rs.3.0 crores.

## 26. Evaluation Criteria for assessment of experience in use of technology for road inspection

Evaluation sheet for assessment of experience in use of technology for road inspection					
S. No	Description		Maximum Points	Reference/Details of projects Claimed for self-assessment	Marks self-assessed by the bidder
1	Experience in Network Survey Vehicle (NSV) or better technology for pavement inspection		7		
1.1	Equipment		4		
	(a) Equipment on MOU with Associate or on hiring basis- 2 marks				
	(b) Own Equipment – 4 marks				
1.2	Experience		3		
(i)	1-2 projects	1			
(ii)	3-5 projects	2			
(iii)	> 5 projects	3			
2	Experience in Falling Weight Deflectometer (FWD) or better technology for pavement strength measurement		4		
2.1	Equipment		2		
	(a) Equipment on MOU with Associate or on hiring basis- 1 mark				
	(b) Own Equipment – 2 marks				
2.2	Experience		2		
(i)	1-3 Projects	1			
(ii)	>3 Projects	2			
3	Experience in Mobile Bridge Inspection Unit or better technology for bridge inspection		5		
3.1	Equipment		2		
	(a) Equipment on MOU with Associate or on hiring basis- 1 mark				
	(b) Own Equipment – 2 marks				
3.2	Experience		3		
(i)	1-2 Projects	1			
(ii)	3-5 Projects	2			
(iii)	> 5 Projects	3			
4	Experience in Retro Reflectometer technology		4		
4.1	Equipment		2		

	(a) Equipment on MOU with Associate or on hiring basis- 1 mark			
	(b) Own Equipment – 2 marks			
4.2	Execution with owned/hired Equipment/through Associate	2		
(i)	1-3 Projects	1		
(ii)	>3 Projects	2		
	<b>Total</b>	<b>20</b>		

**Notes:**

- (i) The Consultants owning the equipment shall be required to submit proof of ownership.
- (ii) The experience of the associate firms in use of technology shall also be counted in the evaluation. The experience of firm or associate firm in NSV or equivalent technology, FWD or equivalent technology, MBIU or equivalent technology and Retro Reflectometer or equivalent technology shall be supported by experience certificate. The experience of a firm/ associate firm for a private concessionaire/ contractor (client) shall be considered on self-certification along with the client certificate. Any false certification shall attract provisions of Clause 1.8, Section -2 (letter of Invitation) read with Clause 2.9.1(g) of GCC.

3. Evaluation Criteria for assessment of score of Key Staff for adequacy of the Assignment.

**3.1 Team Leader cum Senior Bridge Engineer:**

S. No.	Description	Max. Points	Reference/Details of projects Claimed for self-assessment	Marks self-assessed by the bidder
<b>1</b>	<b>General Qualification</b>	<b>25</b>		
i)	Graduate in Civil Engineering	21		
ii)	Post Graduation in /Structural Engineering or equivalent specialized stream of civil engineering	04		
<b>2</b>	<b>Adequacy for the Project</b>	<b>70</b>		
<b>a)</b>	<b>Professional Experience in Bridge Projects:</b>			
i)	Total Professional Experience in handling Bridge projects < 12 years -0 12 years -12 marks Add 1 mark extra for each additional year of experience subject to maximum 3 (three) marks.	15		

ii)	<p>Experience as Team Leader or similar capacity in Highway Development projects of (similar configuration (2/4/6 laning**) and above)</p> <p>&lt; 5 years -0</p> <p>5 years -8 marks</p> <p>Add 1 marks extra for each additional year of experience subject to maximum 2 (two) marks.</p>	10		
iii)	<p>Experience as Team Leader or similar capacity in Highway Development projects (of length 40% of project length or more of similar configuration (2/4/6 laning**) and above)</p> <p>1 project -4 marks add 1 mark extra for additional projects subject to maximum 1 (one) mark</p>	5		
b)	<p>Experience as Team Leader or similar capacity of at least Two projects in Construction Supervision / AE/ IE/ Project preparation involving at least one Major Bridge (minimum 300 m length without approaches) in the Project (of length 40% of project length or more of similar configuration (2/4/6 laning**)</p> <p>&lt; 2 projects -0</p> <p>2 Projects -20 marks</p> <p>Add 5 marks for each additional project subject to maximum 10 marks</p>	30		
c)	<p>Experience as Team Leader/Project Manager or similar capacity in Operation and Maintenance of Major Bridge (minimum 300 m length without approaches) in the Project (of length 40% of project length or more of similar configuration (2/4/6 laning**)</p> <p>1 project – 8 marks</p> <p>Add 1 mark extra for each additional project subject to maximum 2 (two) mark</p>	10		
3.	<p>Employment with the Firm</p> <p>&lt; 1 year -0</p> <p>1 year – 3 marks</p> <p>Add 0.5 marks for each subsequent year subject to maximum 2 marks</p>	5		
	<b>Total :</b>	<b>100</b>		

### 3.2 Resident cum Highway Engineer

S. No.	Description	Max. Points	Reference/Details of projects Claimed for self-assessment	Marks self-assessed by the bidder
1	General Qualification	25		
i)	Graduate in Civil Engineering	21		
ii)	Post Graduation in Transportation/ Highway Engineering/Structural Engineering/Geotechnical Engineering	04		
2	Adequacy for the Project	70		
	Professional Experience			
i)	Total Professional Experience in handling Highway projects < 12 years -0 12 years -16 marks Add 1 mark extra for each additional year of experience subject to maximum 4 (four) marks.	20		
ii)	Experience as Resident Engineer/Highway Engineer/Project Director/Project Manager/Superintending Engineer or equivalent/Executive Engineer or equivalent on construction works/ Construction Supervision/ Authority Engineer/ Independent Engineer Projects (similar configuration (2/4/6 laning*) and above). < 5 years -0; 5 years -15 marks Add 1 marks extra for each additional year of experience subject to maximum 5 (five) marks.	20		
iii)	Experience in similar capacity in handling major 2/4/6- laning** projects (of length 40% of project length or more of similar configuration (2/4/6 laning**) and above) < 2 nos. -0 2 nos. -19 marks Add three marks extra for each additional project subject to maximum 6 (Six) marks.	25		
iv)	Experience in similar capacity of Highway Project of Construction/Construction Supervision/IC on EPC Mode (of length 40% of project length or	5		

	more of similar configuration (2/4/6 laning**) and above) 1 Project- 4 marks Add 1 (one) mark extra for each additional project subject to maximum 1 (one) mark			
3.	Employment with the Firm < 1 year -0 1 year – 3 marks Add 0.5 marks for each subsequent year subject to maximum 2 marks	5		
	<b>TOTAL</b>	<b>100</b>		

**Note:**

- (1) Similar Capacity includes the following positions
  - i) On behalf of Consultant: Resident / Highway Engineer
  - ii) On behalf of Contractor: Resident Engineer/ Highway Engineer / Project Manager (Construction/Construction Supervision)
  - iii) In Government Organizations: Executive Engineer (or equivalent) and above
- (2) Only those projects (in numbers) will be considered for evaluation above, where the input of the personnel is not < 12 months
- (3) In case of experience on behalf of Authority's Engineer or Contractor, the experience shall be duly endorsed by the respective Government agency. In case of non-availability of endorsement from Govt. Agency, the experience uploaded on INFRACON Portal will be taken into consideration. However, the key personnel/ bidder will be solely responsible for any fake information/ CV, which may result in debarment.

**3.3 Bridge/Structural Engineer**

S. No.	Description	Max. Points	Reference/Details of projects Claimed for self-assessment	Marks self-assessed by the bidder
1	General Qualification	25		
i)	Graduate in Civil Engineering	21		
ii)	Post-Graduation in Structural Engineering	04		
2	Adequacy for the Project	70		
i)	Total Professional Experience in handling Highway/Bridge projects < 10 years -0 10 years -11 marks Add one mark extra for each additional 2 year subject to maximum 4(four) marks	15		

ii)	Experience in similar capacity in Design/Construction/Construction Supervision of Bridges/ROB/Flyover/Interchanges/any other such structures (similar configuration (2/4/6 laning**) and above) < 5 years -0; 5 years -15 marks Add 1 (one) mark extra for each additional completed year of experience subject to maximum 5 (five) marks	20		
iii)	Experience in similar capacity in Construction/Supervision of Major Highway Bridges/ROB/Flyover/ Interchanges/ any other structures < 2 Bridges -0 02 Bridge -15 marks Add 2.5 mark extra for each additional bridge subject to maximum 5 marks	20		
iv)	Experience in similar capacity in construction/supervision of Rehabilitation and repair of Major Bridges/ROB/Flyover/ Interchanges/ any other structures < 2 nos. – 0 2 nos. -8 marks > 3 nos.- 10	10		
v)	Experience in similar capacity of modern bridge construction technology viz., Precast Segmental, Balanced Cantilever Construction, Extra dosed Bridge, Full Span Launching, Incremental Launching. Experience in 1 project – 4 marks More than one project – 5 marks	5		
3	Employment with the Firm < 1 year -0 1 year -3 marks Add 0.5 marks for each subsequent year subject to maximum 2 marks	5		
	<b>TOTAL</b>	<b>100</b>		

**Note:**

- (1) Similar Capacity includes the following positions
- i) On behalf of Consultant/Contractor: Bridge Engineer/Project Manager (Bridges)
  - ii) On behalf of Government: Executive Engineer

(2) Only those projects (in numbers) will be considered for evaluation above, where the input of the personnel is not < 12 months

(3) In case of experience on behalf of Authority's Engineer or Contractor, the experience shall be duly endorsed by the respective Government agency. In case of non-availability of endorsement from Govt. Agency, the experience uploaded on INFRACON Portal will be taken into consideration. However, the key personnel/ bidder will be solely responsible for any fake information/ CV, which may result in debarment.

### 3.4 Senior Quality/Material Expert

S. No.	Description	Max. Points	Reference/Details of projects Claimed for self-assessment	Marks self-assessed by the bidder
1	General Qualification	25		
	I) Graduate in Civil Engineering	21		
	II) Post Graduation in Geotechnical Engineering/ Foundation Engineering/ Soil Mechanics/ Rock Mechanics	04		
2	Adequacy for the Project	70		
	Professional Experience			
i)	Total Professional Experience in handling Highway/Bridge projects < 10 years -0 10 years -11 Add one mark extra for each additional year of experience subject to maximum 4 (four) marks.	15		
ii)	Experience in similar capacity in Construction/Construction Supervision of major Highway Projects ((similar configuration (2/4/6 laning**) and above) < 5 years -0; 5 years -19 Add 2.0 (two) marks extra for each additional year of experience subject to maximum 6 (Six) marks.	25		
iii)	Experience in similar capacity in handling Similar Highway projects (of length 40% of project length or more of similar configuration (2/4/6 laning**) and above) < 2 nos. -0 2 nos. - 25 Add 2.5 marks extra for each additional project subject to maximum 5 (five) marks.	30		

3	Employment with the Firm < 1 year – 0 1 year – 3  Add 0.5 marks for each subsequent year subject to maximum 2 marks	5		
	<b>Total :</b>	<b>100</b>		

**Note:**

- (1) Similar Capacity includes the following positions
  - i) On behalf of Consultant/Contractor: Quality Expert/ Material Engineer/Material Expert/ Quality Engineer/ Geo-Technical Expert.
  - ii) On behalf of Government: Executive Engineer
- (2) Only those projects (in numbers) will be considered for evaluation above, where the input of the personnel is not < 12 months
- (3) In case of experience on behalf of Authority's Engineer or Contractor, the experience shall be duly endorsed by the respective Government agency. In case of non-availability of endorsement from Govt. Agency, the experience uploaded on Infracon Portal will be taken into consideration. However, the key personnel/ bidder will be solely responsible for any fake information/ CV, which may result in debarment.

**3.5 Senior Contract Specialist**

S. No.	Description	Max. Points	Reference/ Details of projects Claimed for self-assessment	Marks self-assessed by the bidder
<b>1</b>	<b>General Qualification</b>	<b>25</b>		
I)	Graduate in Civil Engineering	21		
II)	Post Graduate Degree in Law/PG in management/certificate course in management/certificate course in construction management/certificate course in contract management	04		
<b>2</b>	<b>Adequacy for the Project</b>	<b>70</b>		
	<b>Professional Experience</b>			
i)	Total Professional Experience of Contract Management. < 15 years -0 15 years -15 marks Add one mark extra for each additional year of experience subject to maximum 5 (five) marks.	<b>20</b>		

ii)	Experience as Contract Specialist on any National/State Highway project. < 4 years -0 4 years -15 marks Add one mark extra for each additional year of experience subject to maximum 5 (five) marks.	<b>20</b>		
iii)	Contract Management of a large Highway contract say over Rs. 150 crore including experience of handling variation orders, claims of the contractor and there appropriate disposal < 2 nos. -0 2 nos. -20 Add 2.5 marks extra for each additional project subject to maximum 5 (five) marks.	<b>25</b>		
v)	Experience of Handling Arbitration cases in respect of any Highway project. 1 project -4 marks 2 or more projects-5 marks	<b>5</b>		
3.	Employment with the Firm <1 year- 0 1 year – 3 marks Add 0.5 marks for each subsequent year subject to maximum 2 marks	<b>5</b>		
	<b>Total :</b>	<b>100</b>		

### 3.6 Road Safety Expert

S. No.	Description	Max. Points	Reference/ Details of projects Claimed for self-assessment	Marks self-assessed by the bidder
<b>1</b>	<b>General Qualification</b>	<b>25</b>		
i)	Graduate in Civil Engineering	21		
ii)	Post-Graduation in Traffic/ Transportation/ Safety Engineering or equivalent	04		
<b>2</b>	<b>Adequacy for the Project</b>	<b>70</b>		
	<b>Professional Experience</b>			
i)	Total Professional Experience in handling Highway/Bridge projects < 10 years -0 10 years -11 marks Add one mark extra for each additional year of experience subject to maximum 4 (four) marks.	15		

ii)	Experience in similar capacity in Road Safety works on Major Highway Project (similar configuration (2/4/6 laning**) and above).  <5years-0 5 years -11 marks Add one mark extra for each additional year of experience subject to maximum 4 (four) marks.	15		
iii)	Experience in similar capacity in Road Safety Audits of 2/4/6-laning** Highway projects at different stages including at least one at designstage  < 2 nos. -0 2 nos.-15 marks Add 2.5 marks extra for each additional project subject to maximum 5 marks.	20		
iv)	Experience in similar capacity in identification and improvement of black spots on Major Highway Project (similar configuration (2/4/6 laning**) and above)  < 2 nos. -0 2 nos. -8 marks Add 2 marks extra for each additional improvement of black spots subject to maximum 2 marks.	10		
v)	Experience in similar capacity of preparing Road Safety Management Plans for Inter Urban Highway  1 project -4 marks 2 or more -5 marks	5		
vi)	Experience in similar capacity in field of Road Safety Management Plan  1 project -4 marks 2 or more -5 marks	5		
<b>3</b>	Employment with the Firm  <1 year- 0 1 year – 3 marks Add 0.5 marks for each subsequent year subject to maximum 2 marks	<b>5</b>		
	<b>Total :</b>	<b>100</b>		

**Note:**

- (1) Similar Capacity includes the following positions
  - i) On behalf of Consultant/Contractor: Road Safety Expert
  - ii) In Government Organizations: Executive Engineer (or equivalent) and above
- (2) Only those projects (in numbers) will be considered for evaluation above, where the input of the personnel is not < 6 months

### SECTION 3: FORMATS FOR SUBMISSION OF FIRMS CREDENTIALS

The proposal should contain the following information in enclosed format attached at Appendix A.

- Year of Establishment of Firm
- Average annual turnover (last three years)

**NOTE:** The Firm shall submit Certificate of Incorporation and audited balance sheet for the last three years [FY 2018-2019, FY 2019-2020 and FY 2020-2021]. For claiming experience of Highway projects, completion certificate from employer should be enclosed. The proposal should also contain the details of the key personnel viz. their name, qualification, expertise area, experience and years of association with the firm.

## Appendix A

The following information related to the firm should be provided in the proposal.

- i. Name of the package applied for:-
- ii. Year of establishment of firm\*

Consultant	Year of Establishment	Country	Type of Organization			
			Individual	Partnership	Corporation	Other
Individual / Lead Partner (of JV)/ Minor Partner of JV/Associate						

NOTE: - Year of Establishment of Lead Partner of JV shall be considered.

\*Copy of Certificate of incorporation shall be submitted.

- iii. Office/ Business Address/Telephone nos. /Cable Address.
- iv. Narrative description of firm (Not more than 2 sheets)
- v. Name of two (2) principals who may be contacted with title and telephone number/fax number/e-mail.
- vi. Financial Statement of the last three years. \*\*

Sl. No.	Particular	<2018-2019>	< 2019-2020>	<2020-2021>
i.	Annual turnover from Consulting business			
ii.	Total Assets			
iii.	Current Assets			

Balance Sheet/ Auditor Certificate of last 3years < FY 2018-2019 , FY 2019-2020 and FY 2020-2021> shall be submitted as evidence of Annual Turnover.

\*\* a) The amount shall be stated in INR.

b) Deleted

vii. Experience as Authority Engineer/Independent Consultant/Construction supervision of Highway projects, separately for PPP and non-PPP Projects during the last 7 years. \*\*\*

S No	Projects Name / Year	Type of Services rendered	Description of Highway Project/ Length (kms)	Client (with complete address, contact person, Telephone Nos. and Fax Nos.)	Total Fee for the Consultancy Assignment (INR)	Fee received by Applicant (in case of JV/Association)	%age of total fee received by the firm	Approx. Cost of Highway Project	Period
	Sole Consultant/ Prime Consultant of JV / minor Authority's Engineer of JV/ /as associate Consultant								

		A. Completed / Substantially completed projects: 1. 2. 3. B. Projects in progress: 1. 2. 3.
--	--	---------------------------------------------------------------------------------------------------------------

**viii.** Experience in DPR/ Feasibility Study cum Preliminary Design Report preparation of 2/4/6 laning / Bridge Highway Projects separately for the PPP and non-PPP projects during the last 7 years. \*\*\*

S No	Projects Name / Year	Type of Services Rendered	Length of Project (kms)	Client (with Complete address, contact person, telephone Nos. and FaxNos.)	Total Fee for the Consultancy Assignment (INR)	Fee received by Applicant (in case of JV/Association) case of JV	%age of total fee received by the firm	Period
	Sole Consultant/ Prime Consultant of JV / minor Authority's Engineer of JV/ /as associate Consultant							
1	2	3	4	5	6	7	8	9

\*\*\* a) 2/4/6 lane/Bridge work as applicable for the project for which RFP is invited. For 2-lane projects experience of 4/6 lane is also to be considered with a multiplication factor of 1.5. Experience of 4/6 lane shall be considered interchangeably for 4/6 laning projects. For 4/6 lane projects, experience of 2 lane will be considered with a multiplication factor of 0.4, but only for those 2-lane projects whose cost of consultancy services was more than Rs.3.0 crores. For standalone bridge projects, experience in bridge work (either standalone project or as a part of road project) only be considered.

b) Only those projects, to be included in the table which are Highways Projects and for which clients certificates from the concerned Government agencies are enclosed with the proposal.

c) The details of bridges having length more than 200m (500m in case the project consist of bridges of length more than 500m) in the listed projects is to be specifically mentioned.

d) The weightage given for experience of a firm would depend on the role of the firm in the respective assignments. The firm's experience would get full credit if it was the sole firm in the respective assignment. If the applicant firm has completed projects as JV with some other firms, weightage shall be given as per the JV share\*\*\*. However if the applicant firm has executed the project as associate with some other firms, 25% weightage shall be given to the applicant firm for the projects completed under such association

e) For weightage of experience in any past Consultancy assignment, experience certificate from the client shall be submitted. In absence of clear demarcation of JV share in

client certificate, the weightage will be treated as 60 % for lead partner and 40% for minor partner. Annual turnover duly certified by Chartered Accountant shall be accepted. In case of non-availability of such documents no weightage of turnover/experience will be considered.

**ix** Assignments on hand including those for which the Letter of Acceptance from the clients received as on 7 days prior to due date for submission of proposals: The details shall be given in the following format.

S. No	Name of Assignment	Client	Role of the firm	Date of letter of Acceptance	Date of Agreement if signed	Present status of Assignment	Team Members provided by the firm		
			Sole, Lead/ Other in JV or sub-consultant				Name	DOB	Position
(1)	(2)	(3)	(4)	(5)	(6)	(7)	(8)	(9)	(10)

Key Personnel	Number of key personnel employed		
	Sole Applicant (Lead Member in case of JV)	JV (1)	
Team Leader cum Senior Highway Engineer			
Resident cum Highway Engineer			
Bridge/Structural Engineer			
Senior Quality cum Material Expert			

**SECTION 4: FORMAT FOR SUBMISSION OF TECHNICAL PROPOSAL**

<b>Appendix B-1</b>	Technical proposal submission form.
<b>Appendix B-2</b>	Site Appreciation
<b>Appendix B-3</b>	Approach paper on methodology for performing the assignment
<b>Appendix B-4</b>	Facility for field investigation and testing
<b>Appendix B-5</b>	Composition of the Team and Task(s) of each Team member
<b>Appendix B-6</b>	Curriculum vitae of proposed Professional staff.
<b>Appendix B-7</b>	Time schedule for deployment of Professional staff
<b>Appendix B-8</b>	Activity (works) schedule.
<b>Appendix B-9</b>	Affidavit – Correctness of Experience claimed by the Firms
<b>Appendix B-10</b>	Integrity Pact
<b>Appendix B-11</b>	Details of Ongoing and Awarded works in NHIDCL

**APPENDIX B-1-Technical proposal submission form**

**FROM (Name of Firm)**

-----  
-----  
-----  
-----

**To: (Name and Address of NHIDCL)**

-----  
-----  
-----  
-----

**Subject:** Submission of Technical and Financial Proposal for engagement as Authority Engineer for the EPC work of [Name of the Work]

Sir/Ma'am,

We, the undersigned, offer to provide the consulting services for the above in accordance with your Request for Proposal dated (Date), and our Proposal. We are hereby submitting our Proposal, which includes this Technical Proposal and a Financial Proposal sealed under a separate envelope for the above mentioned work.

(ii) My/Our registration No. on Infracon is ..... And my/our Infracon Team ID is .....

(iii) Our Proposal is binding upon us. We understand you are not bound to accept any Proposal you receive

We remain,

**Yours sincerely,**

**Managing Director/Head of the  
firm/Authorized Representative  
of the firm**

**Name of the firm**

**Address**

**\*Lead Member in case of JV**

## **APPENDIX B-2: SITE APPRECIATION**

Shall give details of site as per actual site visit and data provided in RFP and collected from site supported by photographs to demonstrate that responsible personnel of the Authority's Engineer have actually visited the site and familiarized with the salient details/ complexities and scope of services.

## **APPENDIX B-3: APPROACH PAPER ON METHODOLOGY FOR PERFORMING THE ASSIGNMENT**

The approach and methodology will be detailed precisely under the following topics.

- 1) Methodology for services, surveying, road condition data collection and analysis [not more than 2 pages]
  - Key challenges foreseen and proposed solutions in carrying out the assignment [not more than 1page]
- 2)
- 3) Quality Audit methodology including Quality Assurance Plan [not more than 6 pages]

**APPENDIX B-4: FACILITY FOR FIELD INVESTIGATION AND TESTING**

1. State whether applicant has in-house (created in house at site)/ outsourced/ not available facility for :

- Surface defects detection and roughness measurement using Network Survey Vehicle
- Pavement strength measurement using FWD
- Bridge inspection using Mobile Bridge Inspection Unit
- Road signs inspection using Retro Reflectometer

2. In-case answer to 1 is available (created in house at site) a list of field investigation and testing equipment is to be attached

3. In case answer to 1 is outsourced/not available – arrangements made or proposed to be made for each of the above field investigations is to be attached.

4. For experience in NSV, FWD, MBIU and Reflectometer, references need to be provided in the following format:

**REFERENCES**

Relevant Services Carried Which Best Illustrate Qualifications

The following information should be provided in the format below for each reference assignment for which your firm, either individually as a corporate entity or as one of the major companies within a consortium, was legally contracted by the client:

Assignment Name:		Country:
Location within Country:		Professional Staff Provided by your firm:
Name of Client :		No. of Staff :
Address :		No. of Staff Months :
Technology Used:		
Start Date (Month / Year)	Completion Date (Month / Year)	Approx. Value of Services in INR/current USD):
Name of JV/Association Firm(s)if any:		No. of Months of Professional Staff provided by Associated Firm(s)
Status of your Company in the Assignment i.e., Sole/Lead Member/Other Member/Associate		
Narrative Description of Project :		
Description of Actual Services Provided by your Company:		

Signature of Authorized Representative  
(Certificate from Employer regarding experience should be furnished)

**PPENDIX B-5: COMPOSITION OF THE TEAM PERSONNEL, AND  
TASK(S) OF EACH TEAM MEMBER**

**(i) Technical/Managerial Staff**

<b>S. No.</b>	<b>Name</b>	<b>Position</b>	<b>Task</b>
1			
2			
3			
4			
...			
...			

**(ii) Support Staff**

<b>S. No.</b>	<b>Name</b>	<b>Position</b>	<b>Task</b>
1			
2			
3			
4			
...			
...			

**APPENDIX B-6: FORMAT OF CURRICULUM VITAE (CV) FOR PROPOSED PROFESSIONAL STAFF**

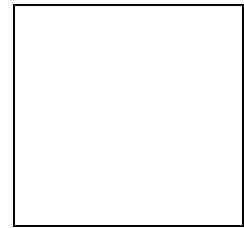

**PHOTOGRAPH**

**Proposed Position :**

**Name of Firm :**

**Name of Staff :**

**Profession :**

**Date of Birth**

**Years with Firm/Entity :**

**Nationality :**

**Membership of Professional Societies :**

**Detailed Task Assigned :** Please attach printout of CV along with all the relevant details uploaded on Infracon portal :

**Certification by the Candidate**

I, the undersigned, (Name and Address) undertake that this CV correctly describes myself, my qualifications and my experience and NHIDCL would be at liberty to debar me if any information given in the CV, in particular the Summary of Qualification & Experience vis-à-vis the requirements as per TOR is found incorrect. I further undertake that I have neither been debarred by NHIDCL or any other central/stage government organization nor left any assignment with the consultants engaged by NHIDCL / contracting firm (firm to be supervised now) for any continuing work of NHIDCL without completing my assignment. I will be available for the entire duration of the current project (named... ). If I leave this assignment in the middle of the work, NHIDCL would be at liberty to debar me from taking any assignment in any of the NHIDCL works for an appropriate period of time to be decided by the NHIDCL. I have no objection if my services are extended by the NHIDCL for this work in future.

I further undertake that my CV is being proposed for this project by [.....] (the applicant firm) and I have not given consent to any other consultant(s) to propose my CV for any position for this project.

I further undertake that if due to my inability to work on this project due to unavoidable circumstances, due to which consultant's firm is forced to seek replacement. In such unavoidable circumstances, I shall not undertake any employment in NHIDCL projects during the period of assignment of this project and NHIDCL shall consider my CV invalid till such time.

I undertake that I have no objection in uploading/hosting of my credentials by NHIDCL in public domain.

For Key Personnel having intermittent inputs, add the following:

I further certify that I am associated with the following assignments as on date (as on 7 days prior to

due date for submission of proposal) including those for which LOA has been received by the firm and the inputs in these assignments shall not affect the work of the current assignment.

Name of Assignment	Client	Date of LOA	Likely start (Month / Year)	Likely end (Month / Year)	Total input of the person (man- months)

DATE: DD/MM/YYYY

Signature Key Personnel

The Authority's Engineer should carryout self-evaluation based on the evaluation criteria at Appendix-EC and furnish the same here. While submitting the self-evaluation along with bid, Authority's Engineer shall make references to the documents which have been relied upon in his self-evaluation.

**Certification by the firm**

The undersigned on behalf of [...]( name of consulting firm) certify that Shri[...] (name of proposed personnel) to the best of our knowledge has neither been debarred by NHIDCL or any other Central/State Government organization nor left his assignment with any other consulting firm engaged by the Employer /Contracting firm(firm to be supervised now) for the ongoing projects. We understand that if the information about leaving the past assignment is known to the NHIDCL, NHIDCL would be at liberty to remove the personnel from the present assignment and debar him for an appropriate period to be decided by theNHIDCL.

Date [DD/MM/YYYY]

**[Signature of authorized representative of the Firm]**

**APPENDIXB-7: TIME SCHEDULE FOR PROFESSIONAL PERSONNEL**

**A. Activity Schedule**

Sl. No.	Name	Position	Month wise Program(in form of Bar Chart)													Number of Months
			[1 <sup>st</sup> , 2 <sup>nd</sup> , etc. are months from the start of assignment]													
			1 <sup>st</sup>	2 <sup>nd</sup>	3 <sup>rd</sup>	4 <sup>th</sup>	5 <sup>th</sup>	6 <sup>th</sup>	7 <sup>th</sup>	8 <sup>th</sup>	9 <sup>th</sup>	10 <sup>th</sup>	11 <sup>th</sup>	12 <sup>th</sup> and subsequent year		
1															Subtotal(1)	
2															Subtotal(2)	
3															Subtotal(3)	
4															Subtotal(4)	
-															-	
-															-	

**APPENDIXB-8: ACTIVITY (WORKS) SCHEDULE**

**B. Activity Schedule**

Sr.No.	Item of Activity (Works)	Month wise Program(information of Bar Chart)											
		[1 <sup>st</sup> ,2 <sup>nd</sup> , etc. are months from the start of assignment]											
		1 <sup>st</sup>	2 <sup>nd</sup>	3 <sup>rd</sup>	4 <sup>th</sup>	5 <sup>th</sup>	6 <sup>th</sup>	7 <sup>th</sup>	8 <sup>th</sup>	9 <sup>th</sup>	10 <sup>th</sup>	11 <sup>th</sup>	12 <sup>th</sup>
1	.....												
2	.....												
3	.....												
4	.....												
-	.....												
-	.....												

**C. Completion and Submission of Reports**

S. No	Reports :	Programme Date)
1	Monthly reports (Design and Construction)	
2	Quarterly Reports	
3	Various others reports as provided in the Contract Agreement such as Completion Report	

**APPENDIX B-9: AFFIDAVIT FOR CORRECTNESS OF CV OF KEY PERSONNEL AND EXPERIENCE  
CLAIMED BY THE FIRMS**

**(To be submitted on non-judicial Stamp Paper)**

I, the undersigned, on behalf of {...}(name of the Authority's Engineer submitting the proposal), do hereby certify that the details furnished in this proposal including CV of key personnel and experience claimed by the firm/firms are true and correct to the best of my knowledge and belief.

**Managing Director/Head of the Firm/  
Authorised Representative of the firm**

**Address**

**Lead Member in case of JV**

## APPENDIX B-10: INTEGRITY PACT

*(To be executed on plain paper and submitted along with Technical Bid/Tender documents for tenders having a value between Rs.5 Cr and 100 Cr. To be signed by the bidder and same signatory competent/ authorized to sign the relevant contract on behalf of the NHIDCL)*

Tender No. [.....]

This integrity Pact is made at [...] on this [.....] day of [...] 2020.

Between

National Highways & Infrastructure Development Corporation Limited, hereinafter referred to as “NHIDCL”, which expression shall unless repugnant to the meaning or contract thereof include its successors and permitted assigns.

And

[.....] hereinafter referred to as “The Bidder/Contractor /Concessionaire/Consultant” and which expression shall unless repugnant to be meaning or context thereof include its successors and permitted assigns.

### **Preamble**

Whereas, NHIDCL intends to award, under laid down organizational procedures, contract/s Consultancy services for Authority’s Engineer for Supervision of [CONSULTANCY SERVICES AS AUTHORITY’S ENGINEER FOR SUPERVISION OF

(I) Construction & Upgradation to 2 lane with paved shoulder from Design Km. 67.805 (at the end of Km 83rd tunnel near Dhrabshala) to Km 80.675 (Dulhasti) of 12.87 Km length on Khellani – Kishtwar –Chattroo section of NH-244 in the Union Territory of Jammu & Kashmir on EPC mode (Pkg –III). & (II) Construction of Kishtwar bypass with 2 lane with paved shoulder from Design Km. 80.675 (Dulhasti) to Km 95.550 (bandarkoot ) of 14.88 Km length on Khellani – Kishtwar –Chattroo section and a link road to Kishtwar town of 1.871 km on NH-244 in the Union Territory of Jammu & Kashmir on EPC mode (Pkg –IV). &(III) Construction /Up gradation 2 lane with paved shoulder from Design Km 95.55 (Bandarkoot ) to Km. 111.06 (Chattroo) of 15.52 Km length on Khellani – Kishtwar –Chattroo section on NH-244 in the Union Territory of Jammu & Kashmir on EPC mode (Pkg –V).]

NHIDCL values full compliance with all relevant laws of the land, rules of land, regulations, economic use of resources and of fairness/ transparency in its relations with its Bidder(s) and/ or Contractor(s)/Concessionaire(s)/ Consultant(s).

And whereas to meet the purpose aforesaid, both the parties have agreed to enter into this Integrity Pact (hereafter referred to as Integrity Pact) the terms and conditions of which shall also be read as integral part and parcel of the Tender documents and contract between the parties. Now, therefore, in consideration of mutual covenants stipulated in this pact, the parties hereby agree as follows and this pact witnesses as under:-

### **Article-1 Commitments of NHIDCL**

1. NHIDCL commits itself to take all measures necessary to prevent corruption and to observe the following principles:-
  - a. No employee of NHIDCL, personally or through family members, will in connection with the tender for, or the execution of a contract, demand, take a promise for or accept, for self, or third person, any material or immaterial benefit which the person is not legally entitled to.
  - b. NHIDCL will, during the tender process treat all Bidder(s) with equity and reason. NHIDCL will in particular, before and during the tender process, provide to all Bidder(s) the same information and will not provide to any Bidder(s) confidential/ additional information through which the Bidder(s) could obtain an advantage in relation to the tender process or the contract execution.
  - c. NHIDCL will exclude all known prejudiced persons from the process, whose conduct in the past has been of biased nature.
2. If NHIDCL obtains information on the conduct of any of its employees which is a criminal offence under the IPC/PC Act or any other Statutory Acts or if there be a substantive suspicion in this regard, NHIDCL will inform the Chief Vigilance Officer and in addition can initiate disciplinary actions as per its internal laid down Rules/Regulations.

**Article – 2: Commitments of the Bidder(s)/ Contractor(s)/ Concessionaire(s)/ Consultant(s).**

The Bidder(s)/ Contractor(s)/ Concessionaire(s)/ Consultant(s) commit himself to take all measures necessary to prevent corruption. He commits himself to observe the following principles during his participation in the tender process and during the contract execution.

- (a) The Bidder(s)/ Contractor(s)/ Concessionaire(s)/ Consultant(s) will not, directly or through any other person or firm, offer, promise or give to any of NHIDCL's employees involved in the tender process or the execution of the contract or to any third person any material or other benefit which he/she is not legally entitled to, in order to obtain in exchange any advantage of any kind whatsoever during the tender process or during the execution of the contract.
- (b) The Bidder(s)/ Contractor(s)/ Concessionaire(s)/ Consultant(s) will not enter with other Bidders into any undisclosed agreement or understanding, whether formal or informal. This applies in particular to prices, specifications, certifications, subsidiary contracts, submission or non-submission or bids or any other actions to restrict competitiveness or to introduce cartelization in the bidding process.
- (c) The Bidder(s)/ Contractor(s)/ Concessionaire(s)/ Consultant(s) will not commit any offence under the relevant IPC/PC Act and other Statutory Acts; further the Bidder(s)/ Contractor(s)/ Concessionaire(s)/ Consultant(s) will not use improperly, for purposes of completion or personal gain, or pass on to others, any information or document provided by NHIDCL as part of the business relationship, regarding plans, technical proposals and business details, including information contained or transmitted electronically.
- (d) The Bidder(s)/ Contractor(s)/ Concessionaire(s)/ Consultant(s) of foreign- origin shall disclose the name and address of the Agents/ Representatives in India, if any. Similarly the Bidder(s)/ Contractor(s)/ Concessionaire(s)/ Consultant(s) of Indian Nationality shall furnish the name and address of the foreign principle, if any.

(e) The Bidder(s)/ Contractor(s)/ Concessionaire(s)/ Consultant(s) will, when presenting his bid, disclose any and all payments he has made, is committed to or intends to make to agents, brokers or any other intermediaries in connection with the award of the contract. He shall also disclose the details of services agreed upon for such payments.

(f) The Bidder(s)/ Contractor(s)/ Concessionaire(s)/ Consultant(s) will not instigate third persons to commit offences outlined above or be an accessory to such offences.

(g) The Bidder(s)/ Contractor(s)/ Concessionaire(s)/ Consultant(s) will not bring any outside influence through any Govt. bodies/quarters directly or indirectly on the bidding process in furtherance of his bid.

**Article – 3: Disqualification from tender process and exclusion from future contracts.**

1. If the Bidder(s)/ Contractor(s)/ Concessionaire(s)/ Consultant(s), before award or during execution has committed a transgression through a violation of any provision of Article-2, above or in any other form such as to put his reliability or credibility in question, NHIDCL is entitled to disqualify the Bidder(s)/ Contractor(s)/ Concessionaire(s)/ Consultant(s) from the tender process.

2. If the Bidder/ Contractor/ Concessionaire/ Authority's Engineer has committed a transgression through a violation of Article-2 such as to put his reliability or credibility into question, NHIDCL shall be entitled to exclude including blacklist and put on holiday the Bidder/ Contractor/ Concessionaire/ Authority's Engineer for any future tenders/ contract award process. The imposition and duration of the exclusion will be determined by the severity of the transgression. The severity will be determined by NHIDCL taking into consideration the full facts and circumstances of each case particularly taking into account the number of transgressions, the position of the transgressors within the company hierarchy of the Bidder/ Contractor/ Concessionaire/ Authority's Engineer and the amount of the damage. The exclusion will be imposed for a minimum of 1 year.

3. A transgression is considered to have occurred if NHIDCL after due consideration of the available evidence concludes that "On the basis of facts available there are no material doubts".

4. The Bidder/ Contractor/ Concessionaire/ Authority's Engineer with its free consent and without any influence agrees and undertakes to respect and uphold NHIDCL's absolute rights to resort to and impose such exclusion and further accepts and undertakes not to challenge or question such exclusion on any ground, including the lack of any hearing before the decision to resort to such exclusion is taken. This undertaking is given freely and after obtaining independent legal advice.

5. The decision of NHIDCL to the effect that a breach of the provisions of this Integrity Pact has been committed by the Bidder/ Contractor/ Concessionaire/ Authority's Engineer shall be final and binding on the Bidder/ Contractor/ Concessionaire/ Consultant.

6. On occurrence of any sanctions/ disqualification etc arising out from violation of integrity pact, the Bidder/ Contractor/ Concessionaire/ Authority's Engineer shall not be entitled for any compensation on this account.

7. Subject to full satisfaction of NHIDCL, the exclusion of the Bidder/ Contractor/ Concessionaire/ Authority's Engineer could be revoked by NHIDCL if the Bidder/ Contractor/ Concessionaire/ Authority's Engineer can prove that he has restored/ recouped the damage caused by him and has installed a suitable corruption prevention system in his organization.

#### **Article – 4: Compensation for Damages.**

1. If NHIDCL has disqualified the Bidder(s) from the tender process prior to the award according to Article-3, NHIDCL shall be entitled to forfeit the Earnest Money Deposit/ Bid Security or demand and recover the damages equivalent to Earnest Money Deposit/ Bid Security (equivalent to 1% of Contract Price) apart from any other legal right that may have accrued to NHIDCL.
2. In addition to 1 above, NHIDCL shall be entitled to take recourse to the relevant provisions of the contract related to Termination of Contract due to Contractor/ Concessionaire/Consultant's Default. In such case, NHIDCL shall be entitled to forfeit the Performance Bank Guarantee of the Contractor/ Concessionaire/ Authority's Engineer and/ or demand and recover liquidated and all damages as per the provisions of the contract/concession agreement against Termination.

#### **Article – 5: Previous Transgression**

1. The Bidder declares that no previous transgressions occurred in the last 3 years immediately before signing of this Integrity Pact with any other Company in any country conforming to the anti corruption/ Transparency International (TI) approach or with any other Public Sector Enterprise/ Undertaking in India or any Government Department in India that could justify his exclusion from the tender process.
2. If the Bidder makes incorrect statement on this subject, he can be disqualified from the tender process or action for his exclusion can be taken as mentioned under Article-3 above for transgressions of Article-2 and shall be liable for compensation for damages as per Article-4 above.

#### **Article-6: Equal treatments of all Bidders/ Contractors/ Concessionaires/ Consultants/ Subcontractors.**

1. The Bidder(s)/ Contractor(s)/ Concessionaire(s)/ Consultant(s) undertake(s) to demand from all sub-contractors a commitment in conformity with this Integrity Pact, and to submit it to NHIDCL before contract signing
2. NHIDCL will enter into agreements with identical conditions as this one with all Bidders/ Contractors/ Concessionaires/ Consultants and Subcontractors.
3. NHIDCL will disqualify from the tender process all Bidders who do not sign this Pact or violate its provisions.

#### **Article – 7: Criminal charges against violating Bidder(s)/ Contractor(s)/ Concessionaire(s)/ Consultant(s)/ Sub-contractor(s).**

If NHIDCL obtains knowledge of conduct of a Bidder/ Contractor/ Concessionaire/ Authority's Engineer or Subcontractor, or of an employee or a representative or an associate of a Bidder/ Contractor/ Concessionaire/ Authority's Engineer or Subcontractor, which constitutes corruption, or if NHIDCL has substantive suspicion in this regard, NHIDCL will inform the same to the Chief Vigilance Officer.

#### **Article – 8: Pact Duration**

This Pact begins when both parties have legally signed it. (In case of EPC i.e. for projects funded by NHIDCL and consultancy services). It expires for the Contractor/ Authority's Engineer 12 months after his Defect Liability period is over or 12 months after his last payment under the contract whichever is later and for all other unsuccessful Bidders 6 months after this Contract has been

awarded. (In case of BOT Projects) It expires for the concessionaire 24 months after his concession period is over and for all other unsuccessful Bidders 6 months after this Contract has been awarded.

If any claim is made/ lodged during this time, the same shall be binding and continue to be valid despite the lapse of this pact as specified above, unless it is discharged/ determined by NHIDCL.

**Article – 10: Other Provisions.**

1. This pact is subject to Indian Law. Place of performance and jurisdiction is the Registered Office of NHIDCL, i.e. ....
2. Changes and supplements as well as termination notices need to be made in writing.
3. If the Bidder/Contractor/Concessionaire/Authority’s Engineer is a partnership or a consortium, this pact must be signed by all partners or consortium members.
4. Should one or several provisions of this agreement turn out to be invalid, the remainder of this agreement remains valid. In this case, the parties will strive to come to an agreement to their original intentions.
5. Any disputes/ differences arising between the parties with regard to term of this pact, any action taken by NHIDCL in accordance with this Pact or interpretation thereof shall not be subject to any Arbitration.
6. The actions stipulated in this Integrity Pact are without prejudice to any other legal action that may follow in accordance with the provisions of the extant law in force relating to any civil or criminal proceedings.

In witness whereof the parties have signed and executed this Pact at the place and date first done mentioned in the presence of following witness:-

(For & On behalf of NHIDCL)

(For & On behalf of the Bidder/Contractor/  
Concessionaire/ Authority’s Engineer)

(Office Seal )

(Office Seal )

Place\_\_

Place\_\_

Date\_\_

Date\_\_

Witness 1 :

Witness 1 :

(Name & Address):

(Name & Address):

Witness 2 :

Witness 2 :

(Name & Address)

(Name & Address)

**SECTION 5: FORMAT FOR SUBMISSION OF FINANCIAL PROPOSAL**

**Appendix C-1** Financial proposal submission form

**Appendix C-2** Summary of costs

**Appendix C-3** Breakdown of costs

**APPENDIX C-1: FINANCIAL PROPOSAL SUBMISSION FORM**

<p>FROM : (Name of Firm)</p>	<p>TO :</p> <p><b>SHRI [B.Shivprasad]</b>  <b>DESIGNATION: General Manager (Tech.)</b>  <b>2<sup>RD</sup> FLOOR, PTI BUILDING, 4-PARLIAMENT STREET, NEW DELHI</b>  <b>011-23461674</b>  <b>EMAIL: <a href="mailto:shivprasad.152p@gov.in">shivprasad.152p@gov.in</a></b></p>
------------------------------	----------------------------------------------------------------------------------------------------------------------------------------------------------------------------------------------------------------------------------------------------------------------------------------------

**Subject: Consultancy services for Authority’s Engineer for Supervision of [Name of the Work]**

We, the undersigned, offer to provide the consulting services for the above in accordance with your Request for Proposal dated [Date], and our proposal. Our attached financial proposal is for the sum of [Amount in words and figures]. This amount is exclusive of the local taxes which we have estimated at (Amount in Words and Figures).

Our financial proposal shall be binding upon us up-to the expiration of the validity period of the proposal, i.e., [Date].

We undertake that, in competing for (and, if the award is made to us, in executing) the above contract, we will strictly observe the laws against fraud and corruption in force in India namely “Prevention of Corruption Act 1988”.

Commission and gratuities, if any, paid or to be paid by us to agents relating to this proposal and contract execution, if we are awarded the contract, are listed below:

Name and Address of Agents	Amount and Currency	Purpose of Commission or Gratuity
.....	.....	.....
.....	.....	.....

We understand you are not bound to accept any proposal you receive.

We remain,

Yours Sincerely,

**Managing Director/Head of the firm/ Authorised Representative of the firm\***

**Name of the firm**

**Address**

**\*Lead Member in case of JV**

**APPENDIX C-2: SUMMARY OF COSTS**

<b>No.</b>	<b>Description</b>	<b>Amount (Rs.)</b>
I	Remuneration for Local Professional Staff	
II	Supporting Staff	
III	Transportation	
IV	Duty Travel to Site	
V	Office Rent	
VI	Office Supplies, Utilities and Communication	
VII	Office Furniture and Equipment	
VIII	Reports and Document Printing	
IX	Road Survey Equipment	
X	Contingencies	
	Sub Total	
	Goods and Services Tax Payable in India	
	Total Costs (Including Tax)	

**Note:** Payments will be made as per stipulations of the Conditions of Contract

**APPENDIX C-3: BREAKDOWN OF LOCAL CURRENCY COSTS**

**I. REMUNERATION FOR LOCAL PROFESSIONAL STAFF**

**Normal Highway Project**

**For Project with Construction Period of [24] months**

No.	Position	Name	Construction Period [24] months+ DLP [60] months		
			Rate	No. of man-months*	Amount
	<b>Professional Staff</b>				
<b>1</b>	Team Leader Cum Senior Bridge Engineer			30	
<b>2</b>	Resident cum Highway Engineer (1 no during construction and ..... during maintenance)			84	
<b>3</b>	Bridge/Structural Engineer (1 no)			24	
<b>4</b>	Senior Quality cum Material Expert (1no during construction)			24	
<b>5</b>	Senior Contract Specialist (1 no)			08	
<b>6</b>	Road Safety Expert (1 no)			18	
	Sub total			188	
	<b>Sub-professional</b>				
<b>1</b>	Survey Engineer (3 nos during Construction Period)			60	
<b>2</b>	Quantity Surveyor (3 nos during Construction Period and 1no during Maintenance Period for 8 months)			68	
<b>3</b>	Lab technician (03 nos during Construction Period)			60	
<b>4</b>	CAD EXPERT			12	
<b>5</b>	Assistant Highway Engineer (3 Nos)			120	
<b>6</b>	Assistant Bridge Engineer(3 No)			120	
	<b>Sub Total</b>			<b>440</b>	
	<b>Total</b>			<b>628</b>	

\* Man months against each Key personnel/Sub professional be same as specified in Enclosure A of TOR.

**II. SUPPORT STAFF**

No.	Position	Name	Staff Months	Billing Rate()	Amount( )
1.	Office Manager (1 no during construction and 1 in maintenance)	TBN	84		
2.	Accountant cum Cashier (1no during construction and 1 in maintenance)	TBN	84		
3.	Steno cum Computer Operator (21no during construction and 1in maintenance) 24+60	TBN	84		
4.	Office Boy (1 no during construction and 1 in maintenance)	TBN	84		
				<b>Total :</b>	

**Note:** Billing rates as indicated above shall be increased in accordance of clause 6.2(a) Special Conditions of Contract for the personnel of all categories namely (i) key Personnel; (ii) sub-Professional personnel and (iii) Support staff. The increase as above shall be payable only on the remuneration part of Key Personnel, Sub-Professional Personnel and support staff. However, for evaluation of Bid proposals, the quoted initial rate shall be multiplied by the total time input for each position on this contract, i.e. without considering the increase in the billing rates

### III. TRANSPORTATION

The vehicles provided by the Consultants shall include the cost for rental, drivers, operation, maintenance, repairs, insurance, etc. for all complete approx. 3000km/month run.

Sr.No	Description of Vehicles	Qty. (No. of vehicle-month)		Total	Rate/ Vehicle- Month	Amount
		During Construction Period	During Development and O&M Period			
1	Scorpio or equivalent 4 x 4 vehicles (not more than 3 years old)	1X24	1X60			
2	Bolero or equivalent 4x4 vehicle(not more than 3 years old)	1x24+2X18	1X60			
	<b>Total</b>					

### IV. DUTY TRAVEL TO SITE (FIXED COSTS) (FOR ALL LENGTHS OF PROJECTS): PROFESSIONAL AND SUB-PROFESSIONAL STAFF

Trips	Number of Trips	Rate*	Amount

\* Rate quoted includes Hotel charges, travel cost etc. complete.

**V. OFFICE RENT (FIXED COSTS) – MINIMUM 200 SQM AREA OF OFFICE SHALL BE RENTED**

The rent cost includes electricity and water charges, maintenance, cleaning, repairs, etc. complete.

No's. of Months	Rate/month	Amount
24 (During Construction)		
60 (During Maintenance)		

**VI. OFFICE SUPPLIES, UTILITIES AND COMMUNICATION (FIXED COSTS)**

No	Item	Months	Monthly Rate	Amount in Rs.
1.	Office Supplies, Drafting Supplies, Computer Running Costs, Domestic and International Communication	(24+60)84		

**VII. OFFICE FURNITURE AND EQUIPMENT (RENTAL)**

The cost shall include rental charges towards all such furniture and equipment as required for proper functioning of office. Office furniture shall include executive tables, chairs, visitor chairs, steel almirahs, computer furniture, conference table etc. Office equipment shall include as a minimum of telephone (with intercom facility), photocopier (15ppm, 12000 copies per month with A3 & A4 input) fax machine, PCs(5 No., Intel Core i3, 19" colour LCD, RAM-8 GB, HDD-500 GB, DVD Writer, Key board, optical scroll mouse, MS- Windows windows 10, pre-loaded anti-virus etc.), laser printers (2 no., 14 PPM, 266 MHZ, 5000 pages per month, 600x600 dpi or better etc., Engineering Plan printer (1 no.), binding machine (1 no.), plotter A0 size, overhead projector, AC (4 no., 1.5 Ton), Water Coolers (as required)etc.

Nos. of Months	Rate/month	Amount
24 (during Construction)		
60 (during Maintenance)		

**VIII. REPORTS AND DOCUMENT PRINTING**

No.	Description	No. of Reports	No. of Copies per Report	Total Nos. of copies	Rate per Copy ( )	Amount
1	Monthly reports (Design and Construction)	24+60=84	3	252		
2	Half yearly Reports	4+10	3	42		

3	Various others reports as provided in the Concession Agreement such as Completion Report	01 (After Project Completion) + 01 (After completion of Maintenance period)	6	12		
				<b>Total</b>		

**IX. ROAD SURVEY EQUIPMENT**

The cost shall include carrying out survey using equipment, manpower, software and report processing.

Item	Kms	Rate per km (INR)	No of times survey to be conducted	Amount (INR)
Surface defects detection and roughness measurement using Network Survey Vehicle	45.14		8	
Pavement strength measurement using FWD	45.14		4	
Bridge inspection using Mobile Bridge Inspection Unit	45.14		8	
Road signs inspection using Retro Reflectometer	45.14		8	
			<b>Total</b>	

**X. CONTINGENCIES**

A fixed amount of Indian Rupees 10 (ten) Lakh shall be included in the Financial Proposal. The provisions of Contingency shall be operated with the specific approval from the Competent Authority in NHIDCL

**SECTION 6**  
**TERMS OF REFERENCE FOR AUTHORITY'S ENGINEER**

[Note: The term "Agreement" and clauses thereof refer to the EPC Agreement dated {.....} entered between NHIDCL and [Name of the Contractor] (the Contractors) for the work of [CONSULTANCY SERVICES AS AUTHORITY'S ENGINEER FOR SUPERVISION OF

**(I) Construction & Upgradation to 2 lane with paved shoulder from Design Km. 67.805 (at the end of Km 83rd tunnel near Dhrabshala) to Km 80.675 (Dulhasti) of 12.87 Km length on Khellani – Kishtwar –Chattroo section of NH-244 in the Union Territory of Jammu & Kashmir on EPC mode (Pkg –III). &**

**(II) Construction of Kishtwar bypass with 2 lane with paved shoulder from Design Km. 80.675 (Dulhasti) to Km 95.550 (bandarkoot ) of 14.88 Km length on Khellani – Kishtwar –Chattroo section and a link road to Kishtwar town of 1.871 km on NH-244 in the Union Territory of Jammu & Kashmir on EPC mode (Pkg –IV). &**

**(III) Construction /Up gradation 2 lane with paved shoulder from Design Km 95.55 (Bandarkoot ) to Km. 111.06 (Chattroo) of 15.52 Km length on Khellani – Kishtwar – Chattroo section on NH-244 in the Union Territory of Jammu & Kashmir on EPC mode (Pkg –V).]**

**1. Scope**

1.1 These Terms of Reference (the "TOR") for the Authority's Engineer are being specified pursuant to the EPC Agreement dated..... (the "Agreement"), which has been entered into between NHIDCL and[Name of the Contractor](the "Contractors") for [Name of the Work] on Engineering, Procurement, Construction (EPC) basis, and a copy of which is annexed hereto and marked as Annex-A to form part of this TOR

1.2 The TOR shall apply to construction and maintenance of the Project Highway.

**2. Definitions and interpretation**

2.1 The words and expressions beginning with or in capital letters and not defined herein but defined in the Agreement shall have, unless repugnant to the context, the meaning respectively assigned to them in the Agreement.

2.2 References to Articles, Clauses and Schedules in this TOR shall, except where the context otherwise requires, be deemed to be reference to the Articles, Clauses and Schedules of the Agreement, and references to Paragraphs shall be deemed to be references to Paragraphs of this TOR.

2.3 The rules of interpretation stated in Clauses 1.2, 1.3 and 1.4 of the Agreement shall apply, *mutatis mutandis*, to this TOR.

**3. General**

3.1 The Authority's Engineer shall discharge its duties in a fair, impartial and efficient manner, consistent with the highest standards of professional integrity and Good Industry Practice.

3.2 The Authority's Engineer shall perform the duties and exercise the authority in accordance

with the provisions of this Agreement, but subject to obtaining prior written approval of NHIDCL before determining.

- (a) Any Time Extension.
- (b) Any additional cost to be paid by NHIDCL to the Contractor;
- (c) The Termination Payment; or
- (d) Any other matter which is not specified in (a), (b) or (c) above and which creates an obligation or liability on either Party for a sum exceeding Rs. 5,000,000 (Rs. Fifty lakh.)

3.3 The Authority's Engineer shall submit regular periodic reports, once every month, to NHIDCL in respect of its duties and functions under this Agreement. Such reports shall be submitted by the Authority's Engineer within 10 (ten) days of the beginning of every month.

3.4 The Authority's Engineer shall inform the Contractor of any delegation of its duties and responsibilities to its suitably qualified and experienced personnel; provided, however, that it shall not delegate the authority to refer any matter for NHIDCL's prior approval in accordance with the provisions of Clause 18.2 EPC Agreement.

3.5 The Authority's Engineer shall aid and advise NHIDCL on any proposal for Change of Scope under Article 13.

3.6 In the event of any disagreement between the Parties regarding the meaning, scope and nature of Good Industry Practice, as set forth in any provision of the Agreement, the Authority's Engineer shall specify such meaning, scope and nature by issuing a reasoned written statement relying on good industry practice and authentic literature.

#### **4. Role and responsibility of Officers of NHIDCL**

The officer in-charge of NHIDCL (e.g. GM/ED/Director in the case of NHIDCL) is responsible for the overall supervision and monitoring of the execution of project as the representative of the owner of the project. The Authority's Engineer is appointed to assist NHIDCL for carrying out the functions as detailed under clause 18.2 of the EPC Agreement. As such, an officer of NHIDCL is vested with all such powers and responsibilities as are enjoined upon the Authority's Engineer and is fully competent to issue any instructions for proper monitoring and supervision of the project, either by himself or through the Authority's Engineer. Instructions issued by the concerned officer of NHIDCL shall have the same effect as that of the Authority's Engineer in terms of this Agreement. Wherever such concerned officer issues any instructions or notice to the Contractor, he shall endorse a copy thereof to the Authority's Engineer

#### **5. Construction Period**

5.1 During the Construction Period, the Authority's Engineer shall review and approve the Drawings furnished by the Contractor along with supporting data, including the geo-technical and hydrological investigations, characteristics of materials from borrow areas and quarry sites, topographical surveys, and the recommendations of the Safety Consultant in accordance with the provisions of Clause 10.1.6 of EPC Agreement. The Authority's Engineer shall complete such review and approve and send its observations to NHIDCL and the Contractor within 15 (fifteen) days of receipt of such Drawings; provided, however that in

case of a Major Bridge or Structure, the aforesaid period of 15 (fifteen) days may be extended upto 30 (thirty) days. In particular, such comments shall specify the conformity or otherwise of such Drawings with the Scope of the Project and Specifications and Standards.

**5.2** The Authority's Engineer shall review and approve any revised Drawings sent to it by the Contractor and furnish its comments within 10 (ten) days of receiving such Drawings. The review/approval of drawing should be authenticated by Authority's Engineer.

**5.3** Quality Assurance Manual and Plan forms the basis of quality of the work. It is therefore essential that the Quality Assurance Manual and Plan prepared by the Concessionaire be checked and approved. Thus, the Authority's Engineer shall check contents of Quality Assurance Plan and Manual of Concessionaire as per requirements of Quality Management System (as per ISO 9001), IRC: SP: 47-1998 and IRC: SP: 57-2000 for road bridges and roads respectively. The Authority's Engineer shall also offer their comments for modifying/ improving the document. After receiving the corrected document, the Authority's Engineer shall review and formally approve the QAM and Quality Plan and send one copy to NHIDCL. The Authority's Engineer shall complete the review of the methodology proposed to be adopted by the Contractor for executing the Works, and convey its comments to the Contractor within a period of 10 (ten) days from the date of receipt of the proposed methodology from the Contractor.

**5.4** The Authority's Engineer shall grant written approval to the Contractor, where necessary, for interruption and diversion of the flow of traffic in the existing lane(s) of the Project Highway for purposes of maintenance during the Construction Period in accordance with the provisions of Clause 10.4 EPC Agreement.

**5.5** The Authority's Engineer shall review the monthly progress report furnished by the Contractor and send its comments thereon to NHIDCL and the contractor within 7 (seven) days of receipt of such report.

**5.6.** On a daily basis, the concerned key personnel of Authority Engineer shall inspect the Construction Works. Following activities need to be undertaken during the visits

- Review of construction including progress, quality and safety of construction
- Inspection of defects and deficiencies in construction works
- Witnessing quality inspection tests at labs established by Concessionaire/Contractor on a sample basis

Review of quality of work shall be done in reference to Quality Assurance Plan (QAP)/Manual and ISO 9001:2008, IRC: SP: 47-1998 and IRC: SP: 57-2000 for road bridges and roads respectively. The Authority's Engineer also needs to capture following documents and send to NHIDCL field office via email on a daily basis

- Scanned copy of filled RFI (Request for Inspection) form including commentary on 'Satisfactory/ Unsatisfactory' nature of work completed by Concessionaire
- Daily inspection report Proforma as provided in Annexure I
- Readings of quality inspection tests witnessed by the Consultant

- Minimum 6 high resolution photographs supporting the remarks made by the Authority's Engineer in RFI form Team Leader will be responsible for sending daily emails to NHIDCL office

**5.7** On a monthly basis, the Authority Engineer shall prepare a **Monthly Inspection Report** in accordance with the format prescribed in **Annexure V** setting forth an overview of the status, progress, quality and safety of construction, including the work methodology adopted, the materials used and their sources, and conformity of Construction Works with the Scope of the Project and the Specifications and Standards. In a separate section of the Inspection Report, the Authority Engineer shall describe in reasonable detail the lapses, defects or deficiencies observed by it in the construction of the Project Highway. The Authority Engineer shall send a copy of its Inspection Report to NHIDCL and the Concessionaire latest by 7<sup>th</sup> of every month. Key sections of the Monthly Progress Report are as follows:

S No.	Section	Sub-Sections
1	<b>Executive Summary</b>	1.1 Construction progress in current month
		1.2 Summary of strip plan
		1.3 Detailed strip plan
		1.4 Current issues and recommended actions by AE
2	<b>Project Overview</b>	2.1 Salient Features of the Project
		2.2 Project Milestones
		2.3 Location Map
		2.4 Key Plan
3	<b>Critical issues and Action log</b>	3.1 Pending issues and action log
		3.2 Obligations as per contract
4	<b>Physical Progress</b>	4.1 Detailed physical progress by component
5	<b>Land Acquisition and Clearances</b>	5.1 LA summary
		5.2 LA detail by CALA
		5.3 LA detail by village
		5.4 Manpower with each CALA
		5.5 Clearances summary
		5.6 Status of utility shifting
6	<b>Change of Scope</b>	6.1 Status of pending COS proposals
7	<b>Mobilization of Resources</b>	7.1 Resource mobilization by contractor/ concessionaire
8	<b>Financial Progress Details</b>	8.1 Pen picture- Escrow
		8.2 Escrow details
9	<b>Summary of quality control tests</b>	9.1 Tests witnessed by IE/AE
		9.2 Tests conducted by IE/AE
10	<b>Monitoring of maintenance obligations during construction phase</b>	10.1 Critical issues and action log
		10.2 Cumulative defects and deficiencies
		10.3 Status of damages
11	Safety features	11.1 Pen picture on safety features at construction site
		11.2 Accident report
12	Annexure	Annex 1: Detailed list of physical components as per Schedule G
		Annex 2 onwards: Additional details provided by AE

**5.8** If at any time during the Construction Period, the Authority Engineer determines that the Concessionaire has not made adequate arrangements for the safety of workers and Users in the zone of construction or that any work is being carried out in a manner that threatens the safety of the workers and the Users, it shall make a recommendation to NHIDCL forthwith, identifying the whole or part of the Construction Works that should be suspended for ensuring safety in respect thereof.

**5.9** The Authority's Engineer shall conduct the pre-construction review of manufacturer's reports and standard samples of manufactured Materials, and such other Materials as the Authority's Engineer may require.

**5.10** For determining that the Works conform to Specifications and Standards, the Authority's Engineer shall require the Contractor to carry out, or cause to be carried out, tests at such time and frequency and in such manner as specified in the Agreement and in accordance with Good Industry Practice for quality assurance. For purposes of this, the tests specified in the IRC Special Publication-11 (Handbook of Quality Control for Construction of Roads and Runways) and the Specifications for Road and Bridge Works issued by MORT&H (the "Quality Control Manuals") or any modifications/substitution thereof shall be deemed to be tests conforming to Good Industry Practice for quality assurance.

**5.11** The Authority's Engineer shall test check at least 60(sixty) percent of the quantity or number of tests prescribed for each category or type of test for quality control by the Contractor.

**5.12** The timing of tests referred to in Paragraph 5.10, and the criteria for acceptance/rejection of their results shall be determined by the Authority's Engineer in accordance with the Quality Control Manuals. The tests shall be undertaken on a random sample basis and shall be in addition to, and independent of, the tests that may be carried out by the Contractor for its own quality assurance in accordance with Good Industry Practice.

**5.13** In the event that results of any tests conducted under Clause 11.10 establish any Defects or deficiencies in the Works, the Authority's Engineer shall require the Contractor to carry out remedial measures.

**5.14** The Authority's Engineer may instruct the Contractor to execute any work which is urgently required for the safety of the Project Highway, whether because of an accident, unforeseeable event or otherwise; provided that in case of any work required on account of a Force Majeure Event, the provisions of Clause 21.6 of EPC Agreement shall apply.

**5.15** In the event that the Contractor fails to achieve any of the Project Milestones, the Authority's Engineer shall undertake a review of the progress of construction and identify potential delays, if any. If the Authority's Engineer shall determine that completion of the Project Highway is not feasible within the time specified in the Agreement, it shall require the Contractor to indicate within 15 (fifteen) days the steps proposed to be take to expedite progress, and the period within which the Project Completion Date shall be achieved. Upon receipt of a report from the Contractor, the Authority's Engineer shall review the same and send its comments to NHIDCL and the Contractor forthwith.

**5.16** The Authority's Engineer shall obtain from the Contractor a copy of all the Contractor's

quality control records and documents before the Completion Certificate is issued pursuant to Clause 12.2 of EPC Agreement.

**5.17** Authority’s Engineer may recommend to NHIDCL, suspension of the whole or part of the Works if the work threatens the safety of the Users and pedestrians. After the Contractor has carried out remedial measure, the Authority’s Engineer shall inspect such remedial measures forthwith and make a report to NHIDCL recommending whether or not the suspension hereunder may be revoked.

**5.18** In the event that the Contractor carries out any remedial measures to secure the safety of suspended works and users, and requires the Authority’s Engineer to inspect such works, the Authority’s Engineer shall inspect the suspended works within 3 (three) days of receiving such notice, and make a report to NHIDCL forthwith, recommending whether or not such suspension may be revoked by NHIDCL.

**5.19** The Authority’s Engineer shall carry out, or cause to be carried out, all the Tests specified in Schedule-K and issue a Completion Certificate or Provisional Certificate as the case may be. For carrying out is functions under this Paragraph 4.18 and all matters incidental thereto, the Authority’s Engineer shall act under and in accordance with the provisions of Article 12 and Schedule-K. The Authority’s Engineer shall use following equipment in carrying out the tests.

S NO	KEY METRICS OF ASSET	EQUIPMENT TO BE USED
1	Surface defects of pavement	Network Survey Vehicle (NSV)
2	Roughness of pavement	Laser Profilometer
3	Strength of pavement	Falling Weight Reflectometer (FWD)
4	Bridges	Mobile Bridge Inspection Unit (MBIU)
5	Road signs and road markings	Retro-Reflectometer

## 6. Maintenance Period

**6.1** The Authority’s Engineer shall aid and advise the Contractor in the preparation of its monthly Maintenance Programme and for this purpose carry out a joint monthly inspection with Contractor

**6.2** The Authority’s Engineer shall undertake regular inspections, at least once every month to evaluate compliance with the Maintenance Requirements and submit a Maintenance Inspection Report to NHIDCL and the Contractor.

### 6.3 Visual Inspection of project highway

**6.3.1** The Authority Engineer shall carry out visual inspection of entire highway stretch as per the frequency defined in the following table :

Nature of defect or deficiency		Frequency of inspection
<b>ROADS</b>		
(a)	<b>Carriageway and paved shoulders</b>	
(i)	Breach or blockade	Daily

(ii)	Pot holes	Daily
(iii)	Cracking	Weekly
(iv)	Rutting	Weekly
(v)	Bleeding/skidding	Weekly
(vi)	Ravelling/Stripping of bitumen surface	Weekly
(vii)	Damage to pavement edges	Weekly
(viii) )	Removal of debris	Daily
<b>(b)</b>	<b>Hard/earth shoulders, side slopes, drains and culverts</b>	
(i)	Variation by more than 2% in the prescribed slope of camber/crossfall	Weekly
(ii)	Edge drop at shoulders	Weekly
(iii)	Variation by more than 15% in the prescribed side (embankment) slopes	Weekly
(iv)	Rain cuts/gullies in slope	Weekly
(v)	Damage to or silting of culverts and side drains during and immediately preceding the rainy season	Weekly
(vi)	Desilting of drains in urban/semi-urban areas	Daily
<b>(c)</b>	<b>Road side furniture including road signs and pavement marking</b>	
(i)	Damage to shape or position; poor visibility or loss of retro-reflectivity	Daily
<b>(d)</b>	<b>Street lighting and telecom (ATMS)</b>	
(i)	Any major failure of the system	Daily
(ii)	Faults and minor failures	Daily
(iii)	Streetlight with Lux Meter	Weekly
<b>(e)</b>	<b>Trees and plantation</b>	
(i)	Obstruction in a minimum head-room of 5 m above carriageway or obstruction in visibility of road signs	Daily
(ii)	Deterioration in health of trees and bushes	Weekly
(iii)	Replacement of trees and bushes	Weekly
(iv)	Removal of vegetation affecting sight line and road structures	Weekly
<b>(f)</b>	<b>Rest areas/Wayside amenities</b>	
(i)	Cleaning of toilets	Daily
(ii)	Defects in electrical, water and sanitary installations	Daily
<b>(g)</b>	<b>Toll plaza[s]</b>	
(i)	Failure of toll collection equipment including ETC or lighting	Daily
(ii)	Damage to toll plaza	Weekly
<b>(h)</b>	<b>Other Project Facilities and Approach roads</b>	
(i)	Damage or deterioration in Approach Roads, -[pedestrian facilities, truck lay-bys, bus-bays, bus-shelters, cattle crossings, Traffic Aid Posts, Medical Aid Posts and other works]	Daily
<b>(j)</b>	<b>Incident Management</b>	
(i)	Instances of Incident Management as reported including time of call, response time, services rendered and time of clearing of the Highway.	Daily
(ii)	List of the Incident Management Services rendered.	Weekly
<b>BRIDGES</b>		
<b>(a)</b>	<b>Superstructure of bridges</b>	
(i)	Cracks	Weekly
(ii)	Spalling/scaling	Weekly
<b>(b)</b>	<b>Foundations of bridges</b>	
(i)	Scouring and/or cavitation	Weekly

<b>(c)</b>	<b>Piers, abutments, return walls and wing walls of bridges</b>	
(i)	Cracks and damages including settlement and tilting	Weekly
<b>(d)</b>	<b>Bearings (metallic) of bridges</b>	
(i)	Deformation	Weekly
<b>(e)</b>	<b>Joints in bridges</b>	
(i)	Loosening and malfunctioning of joints	Weekly
<b>(f)</b>	<b>Other items relating to bridges</b>	
(i)	Deforming of pads in elastomeric bearings	Weekly
(ii)	Gathering of dirt in bearings and joints; or clogging of spouts, weep holes and vent-holes	Weekly
(iii)	Damage or deterioration in parapets and handrails	Weekly
(iv)	Rain-cuts or erosion of banks of the side slopes of approaches	Weekly
(v)	Damage to wearing coat	Weekly
(vi)	Damage or deterioration in approach slabs, pitching, apron, toes, floor or guide bunds	Weekly
(vii)	Growth of vegetation affecting the structure or obstructing the waterway	Weekly

**6.3.2** All elements which have daily inspection frequency shall be inspected weekly as well. Similarly, all elements which have weekly inspection frequency shall be inspected monthly as well.

**6.3.3** Daily inspection report format and weekly inspection report format has been provided in Annexure II and III of this document respectively. Manpower which needs to conduct visual inspection and mode of reporting is defined in the following table

<b>Frequency of inspection</b>	<b>Inspection to be carried out by</b>	<b>Mode of reporting</b>
Daily	Sub-professional staff	Soft copy by Email
Weekly	Key personnel	Soft copy by Email
Monthly	Key personnel	Hard copy and Soft copy

**6.3.4** High resolution photographs and video of the highway stretches having defects and/or deficiencies shall be submitted along with Weekly Inspection Report and Monthly Status Report. Summary of key observations around defects and deficiencies in highway stretch shall be reported in Monthly Progress Report and detailed inspection report shall be provided as Annexure to Monthly Progress Report.

**6.3.5** The Authority's Engineer shall also be responsible for inspection and monitoring of Wayside Amenities. ETC (Electronic Toll Collection) and ATMS (Advanced Traffic Management System) and incident management.

#### **6.4 Road conditions survey**

**6.4.1** The carrying out of condition surveys will be one of the most important and crucial field tasks under the project. The Authority Engineer shall carry out condition surveys using equipment and following a frequency as defined under.

S No	Key metrics of Asset	Equipment to be used	Frequency of condition survey
1	Surface defects of pavement	Network Survey Vehicle (NSV)	At least twice a year (As per survey months defined for the state basis rainy season)
2	Roughness of pavement	Laser Profilometer	At least twice a year (As per survey months defined for the state basis rainy season)
3	Strength of pavement	Falling Weight Reflectometer (FWD)	At least once a year
4	Bridges	Mobile Bridge Inspection Unit (MBIU)	At least twice a year (As per survey months defined for the state basis rainy season)
5	Road signs	Retro-Reflectometer	At least twice a year (As per survey months defined for the state basis rainy season)

The first equipment based inspection shall be conducted at the time of completion testing. The other inspections shall be conducted before and after the rainy seasons as per the schedule defined in Annexure IV, except for FWD testing which shall be conducted once a year.

Calibration of equipment, wherever needed, is required to be done in presence of Competent Authority. Once approval of equipment, the settings and a sample data set is provided by Competent Authority, network level data for entire project stretch can be collected. Month of survey for each state has been defined in Annexure IV of this document.

#### 6.4.2 Measurement of pavement surface defects and roughness

i. The Authority Engineer shall use Network Survey Vehicles mounted with equipment such as Laser based automatic crack detection , high resolution digital cameras for RoW and pavement, high accuracy DGPS receiver and in vehicle data processing software or better technology to accurately measure following pavement surface properties

Surface defect	Dimensions to be reported
Cracking	Length Width Depth
Potholes	Area Depth
Raveling	Indicator % Area
Rutting	Depth Width
Concrete Joint/ Faulting	Length
Roughness	IRI in both wheel paths

ii. The following criteria shall be met by the process of defects detection

- Measurement of 3D road profile using such technologies as laser scanning or other proven technologies.
- Ability to operate (collect data) at different speeds with a minimum speed of 30km/hr and upto at least 75 km/ hr.
- Profile depth accuracy of 0.5mm
- Capability for lane tracking to control driver wander' and ensure high repeatability of data between surveys.
- Measure at least 3.5m width of highway lane.
- Transverse Profile including rut depth measurement of pavement surface widths of both carriageway and shoulders. The rut depth data must be convertible to different straightedge lengths (1.8m to 3.5m) and meet industry standards (ASTM E1703 / E1703M).
- Pavement images with capability to automatically identify and rate distresses
- Roughness measurement with outputs of both raw longitudinal profiles and International Roughness Index (IRI) calculation shall be reported at least 100m referenced to the preceding Location Reference Post (LRP). The roughness must meet ASTM-E950 (equivalent to Class I road profiler). The IRI shall be determined in both wheel paths.
- Ability to record images at user-defined intervals (e.g. every 5, 10m, etc.)
- Minimum images resolution of 1600x1200
- Outputs must include Standard JPEG image or similar industry standard
- Distance resolution of <1mm,
- Capable of achieving distance accuracy of 0.1% (i.e. within 1m over 1km distance)
- All data outputs should be in a non-proprietary format (e.g. .CSV, .MDB, Excel) and not require specialist software in order to view or format data
- Data should also be capable of being easily formatted into data compatible with HDM-4

iii. The following are the set of deliverables which should be submitted after completion of survey as part of Monthly Progress Report

- Raw data generated from the equipment which are part of Network Survey covering the parameters mentioned in above table. It should also include
  - Survey ID, Description, Date, Lane
  - GPS referenced data for GIS mapping
- Video logging
  - Pavement imagery (AVI/JPEG)
  - 360 degree imagery (JPEG)
- Interpretation report covering summary of entire survey and analysis of defects and deficiencies

#### **6.4.3 Measurement of pavement strength**

(i) The Authority Engineer shall carry out structural strength surveys for existing pavements using Falling Weight Deflectometer technique in accordance with the procedure given in IRC:115-2014 (Guidelines for Structural Evaluation and Strengthening of Flexible Road Pavements Using Falling Weight Deflectometer (FWD) Technique) and IRC: 117-2015 (Guidelines for the Structural Evaluation of Rigid Pavement by Falling Weight Deflectometer)

(ii) The interval at which deflection measurements are to be taken up are as per IRC:115- 2014 / IRC:117-2015. For flexible pavements, the sample size and the interval of the data to be collected depends on the length of the uniform section calculated and condition of the pavement section i.e. 'good', 'fair' and 'poor' for each lane, established on the pavement condition data based on the criterion given in IRC:115-2014. For rigid pavements, the deflection data may be collected at interiors, corners, transverse joints and longitudinal joints in the outer lanes at intervals as specified in IRC:117-2015.

(iii) The following are the set of deliverables which should be submitted after completion of inspection test as part of Monthly Progress Report

- Data report covering following parameters
  - Deflection Bowl (Transient Deflections at seven different points)
  - Corrected Elastic Modulus Bituminous E1
  - Corrected Elastic Modulus Granular E2
  - Corrected Elastic Modulus Subgrade E3
  - Subgrade CBR
- Interpretation report covering summary of entire survey results and analysis of key parameters

**6.4.4** The Authority Engineer shall carry out the condition and structural assessment survey of the bridges in accordance with IRC-SP; 35 with the use of Mobile Bridge Inspection unit (MBIU) or better technology.

(i) The following criteria shall be met by the process of bridge condition assessment

- Automatic folding and unfolding of platform
- 90 degree rotation of platform
- Sufficient safety features to be incorporated such as dedicated power supply, emergency cut off system, etc
- Complete access to hidden parts of the bridge by the raters

(ii) Detailed bridge inspection report shall be submitted as per the Inspection Proforma provided in IRC-SP 35.

#### **6.4.5 Measurement of retro reflection of road sign**

(i) The Authority Engineer shall measure Coefficient of retro reflected luminance  $R_A$  (night time retro reflection) of road traffic signs using a portable retro Reflectometer.

(ii) The following criteria shall be met by the process of road signs retro reflection measurement

- Measurement of retro reflective signs shall be conducted in accordance with ASTM E1709 and ASTM E2540
- Measurement time after pressing trigger shall be less than or equal to 1 sec
- Observation angle adjustment from 0.2 degrees to 2.0 degrees

- Entrance angle adjustment from -45 degrees to +45 degrees
- Self-contained commercially available battery
- Inbuilt data storage of at least 2,000 measurements so that data transfer requirement is minimized while the survey is being conducted
- Interface for transferring data from device to Computer
- Built in GPS to capture GPS coordinates of road sign
- Range shall be at least 0-2000 cd/lx/m2

(iii) The following are the set of deliverables which should be submitted after completion of survey as part of Monthly Progress Report.

- System generated coefficient of retro reflected luminance RA (nighttime retro reflection) of all road signs
- Interpretation report covering analysis of road signs falling in different range of RA and actions to be taken

**6.5** The Authority Engineer shall carry out following inspections of ETC lanes at toll plazas on a month basis:

(i) *Infrastructure:*

- Availability of civil infrastructure at toll plazas required for installation of ETC systems
- Adequacy of hardware, software and other related items as per IHMCL/ NHIDCL technical specifications and requirements.

(ii) *Operations:*

- Adherence of various stakeholders (acquirer bank, system integrator, toll operator, issuer bank etc) of the ETC system to the service level agreements
- Efficacy of the ETC system (RFID tagging, AVC, WIM etc) in terms of accuracy and uptime
- Tracking and reporting toll plaza experience metrics such as average waiting time, transaction times for different modes of payment (RFID, cash, smart cards, QR codes etc) and congestion levels (eg. length of queue in different lanes) across 4 different times in a day
- Robustness of dispute resolution mechanisms in place for the tag holder and toll operators by the issuer and acquirer banks

**6.6** The Authority Engineer shall prepare a Monthly Status Report in O&M phase of project in respect of its duties and functions under this Agreement and in accordance with the format prescribed in Annexure VI. 1st deliverable of the report which is an executive summary to the main report (Section 1) shall be submitted to NHIDCL and updated on the PMIS and project specific website by 4th of every month. Main report (Section 2 onwards) shall be submitted to NHIDCL and updated on the PMIS and project specific website by 7th of every month. Key sections of the Monthly Status Report are as follows:

S.No	Sections	Sub sections
1	Executive Summary	1.1 Overall road condition
		1.2 Key reporting metrics
		1.3 Key maintenance activities undertaken
		1.4 Pending issues

		1.5 Recommended actions by AE
		1.6 Strip plan for maintenance
2	Project Overview	2.1 Key project details
		2.2 Location map
		2.3 Key plan
		2.4 Summary of project features
		2.5 RoW availability
3	Critical issues and action taken	3.1 Issue and action log
		3.2 Summary of deficiencies
		3.3 Obligations as per contract
		3.4 Inspection schedule
4	Monthly Inspection Report	4.1 Summary of NCR issued
		4.2 Equipment based inspection report
5	Monitoring of ETC Lanes	5.1 Monthly ETC Report
		5.2 On-ground infrastructure report
		5.3 On ground ETC operations & SLA adherence
6	Status of damages	6.1 Damages for non completion of project facilities
		6.2 Damages for breach of maintenance activities
		6.3 Damages for non completion of major maintenance works
7	Change of Scope proposals	7.1 Change of Scope proposals
8	Status of pending disputes	8.1 Status of pending disputes
9	Reports	9.1 Toll collection statement
		9.2 Accident Report
		9.3 Details of user complaints
		9.4 Encroachment list
		9.5 Lane closure report
10	Annexures	Annex I- Detailed visual inspection report of project highway
		Annex II onwards- Additional details provided by AE

**6.7** The Authority’s Engineer shall specify the tests, if any, that the Contractor shall carry out, or cause to be carried out, for the purpose of determining that the Project Highway is in conformity with the Maintenance Requirements. It shall monitor and review the results of such tests and remedial measures, if any, taken by the Contractor in this behalf.

**6.8** In respect of any defect or deficiency referred to in Paragraph 3 of Schedule-E, the Authority’s Engineer shall, in conformity with Good Industry Practice, specify the permissible limit of deviation or deterioration with reference to the Specifications and Standards and shall also specify the time limit for repair or rectification of any deviation or deterioration beyond the permissible limit.

**6.9** The Authority’s Engineer shall examine the request of the Contractor for closure of any lane (s) of the Project Highway for undertakings maintenance/repair thereof, and shall grant permission with such modifications, as it may deem necessary, within 5 (five) days of receiving a request from the Contractor. Upon expiry of the permitted period of closure, the Authority’s Engineer shall

monitor the reopening of such lane (s), and in case of delay, determine the Damages payable by the Contractor to NHIDCL under Clause 14.5 of EPC Agreement

## **7. Determination of costs and time**

**7.1** The Authority's Engineer shall determine the costs, and/or their reasonableness, that are required to be determined by it under the Agreement.

**7.2** The Authority's Engineer shall determine the period of Time Extension that is required to be determined by it under the Agreement.

**7.3** The Authority's Engineer shall consult each Party in every case of determination in accordance with the provisions of Clause 18.5 of EPC Agreement.

## **8. Payments**

**8.1** The Authority's Engineer shall withhold payments for the affected works for which the Contractor fails to revise and resubmit the Drawings to the Authority's Engineer in accordance with the provision of Clause 10.2.4 (d) of EPC Agreement.

**8.2** Authority's Engineer shall

**(a)** within 10 (ten) days of receipt of the Stage Payment Statement from the Contractor pursuant to Clause 19.4, determine the amount due to the Contractor and recommend the release of 90 (ninety) percent of the amount so determined as part payment, pending issue of the Interim Payment Certificate; and

**(b)** within 15 (fifteen) days of the receipt of the Stage Payment Statement referred to in Clause 19.4, deliver to NHIDCL and the Contractor an Interim Payment Certificate certifying the amount due and payable to the Contractor, after adjustments in accordance with the provisions of Clause 19.10 of EPC Agreement.

**8.4** The Authority's Engineer shall, within 15 (fifteen) days of receipt of the First stage Maintenance Payment Statement from the Contractor pursuant to Clause 19.6 of EPC Agreement, verify the Contractor's statement and certify the amount to be paid to the Contractor in accordance with the provisions of the Agreement.

**8.5** The Authority's Engineer shall certify final payment with 30 (thirty) days of the receipt of the final payment statement of Maintenance in accordance with the provisions of Clause 19.16 of EPC Agreement.

## **9. Other duties and functions**

The Authority's Engineer shall perform all other duties and functions as specified in the Agreement.

## **10. Miscellaneous**

**10.1** All key personnel and sub professional staff of the Authority Engineer shall use the fingerprint based (biometric) attendance system for marking their daily attendance. Attendance shall be marked at least once a day and anytime during the day. 1 Biometric Attendance System shall be installed by the Authority Engineer at its own cost at the site office in order to facilitate the attendance marking. More systems can be installed near the project highway upto a maximum of 1 system per 50 km in order to encourage frequent visits of project highway by key personnel and sub professional staff. A copy of monthly attendance records shall be attached with Monthly Status Report. Proper justification shall be provided for cases of absence of key personnel/ sub professional staff which do not have prior approval from Project Director of concerned stretch.

**10.2** A copy of all communications, comments, instructions, Drawings or Documents sent by the Authority's Engineer to the Contractor pursuant to this TOR, and a copy of all the test results with comments of the Authority's Engineer thereon, shall be furnished by the Authority's Engineer to NHIDCL forthwith

**10.3** The Authority's Engineer shall retain at least one copy each of all Drawings and Documents received by it, including 'as – built' Drawings and keep them in its safe custody.

**10.4** Within 90 (ninety) days of the Project Completion Date, the Authority's Engineer shall obtain a complete set of as built Drawings in 2 (two) hard copies and in micro film form or in such other medium as may be acceptable to NHIDCL, reflecting the Project Highway as actually designed, engineered and constructed, including an as-built survey illustrating the layout of the Project Highway and setback lines, if any, of the buildings and structures forming part of project Facilities; and shall hand them over to NHIDCL against receipt thereof.

**10.5** The Authority's Engineer, if called upon by NHIDCL or the Contractor or both, shall mediate and assist the Parties in arriving at an amicable settlement of any Dispute between the Parties.

**10.6** The Authority's Engineer shall inform NHIDCL and the Contractor of any event of Contractor's Default within one week of its occurrence.

## **11. Performance Clause**

Authority's Engineers shall be expected to fully comply with all the provisions of the 'Terms of Reference', and shall be fully responsible for supervising the Designs, Construction and maintenance and operation of the facility takes place in accordance with the provisions of the EPC Agreement and other schedules. Any failure of the Authority Engineer in notifying to NHIDCL and the Contractor on non-compliance of the provisions of the EPC Contract Agreement and other schedules by the EPC Contractor, non-adherence to the provision of ToR and non-adherence to the time schedule prescribed under ToR shall amount to non-performance.

The Authority Engineer shall appoint its authorized representative, who shall issue on behalf of the AE, Completion Certificate along with the Team Leader and shall carry out any such task as may be decided by NHIDCL. The AE shall take prior approval of NHIDCL before issuing Completion Certificate. The proposal submitted shall also include the name of the authorized representative along with the authorization letter and power of attorney

## **12. CONSULTANT'S PROPOSAL**

**12.1** List of key personnel to be fielded by the Consultants shall be as below:

**Normal Highway Project:**

- i. Team Leader Cum Senior Bridge Engineer
- ii. Resident cum Highway Engineer
- iii. Senior Quantity cum Material Expert
- iv. Bridge/Structural Engineer
- v. Senior Contract Specialist
- vi. Road Safety Engineer

**12.2** Broad job-description and minimum qualification for key personnel mentioned above is enclosed as **Enclosure–B**. However, higher marks shall be accorded to the Candidate with higher relevant qualification and experience. All the CV's of the personals mentioned in Para5.3 (iii) of Data Sheet shall be evaluated at the time of evaluation of technical proposal. **The age of the Key Personnel should not be more than 65 years on the date of submission of proposal.** Consultants are advised in their own interest to frame the technical proposal in an objective manner as far as possible so that these could be properly assessed in respect of points to be given as part of evaluation criteria. The bio-data of the key personnel should be signed on every sheet by the personnel concerned and the last sheet of each bio-data should also be signed by the authorised signatory for the Consultant. The key personnel shall also certify at the end of their bio- data proforma that they have not left any of the Employer works without completing of their assignment and have not accepted any other offer at the time of signing of the bio-data and as such shall be available to work with the Authority Engineer, if the Project is awarded. In case the key personnel leaves the assignment without approval of Employer, Employer would beat liberty to take any appropriate action against that key personnel including debarment. The CV submitted by selected firm/JV shall be hoisted on official website of Employer.

**12.3** In addition to above, consultants are required to propose other key personnel, sub-professional staff and other field engineers as detailed in **Enclosure-A** and the minimum qualification requirements for the same is enclosed in **Enclosure–B**.

**13. PERIOD OF SERVICES**

**13.1** The services of an Authority's Engineer will be in phases as per Contract Agreement.

**13.1.1** The appointment of the Authority's Engineer shall initially be as per details given below

<b>Period of service (in months)</b>	<b>Construction period (in months)</b>	<b>Maintenance/ DLP Period (in months)</b>
Construction Period + DLP Period as per Civil Contract Agreement	[24] Months	DLP Period as per Civil Contract Agreement ([60] months)

The proposed manpower deployment for this period shall be matching the activities to be performed during the said period. The time frame for services during the deployment of key personnel during this period shall be as shown in **Enclosure A**. Extension of Time for providing services of the Authority's Engineer may be extended concurrently with the Extension of Time granted, if any, to the EPC Contractor for the project, subject to satisfactory performance of the Authority's Engineer

#### **14. Project Coordinator**

The Firm shall appoint personnel from its head office to act as Project Coordinator for the assignment. He will be authorised to communicate with NHIDCL in respect of all matters pertaining to the project. The cost of the Project Coordinator shall be incidental to the Consultancy Assignment.

**15.** The Authority Engineer shall carry out Project Safety Audit and Project Quality Audit every Six months from the Start of the Project to its completion, which shall include audit of the following:

- (a). Audit of Execution of Work
- (b). Audit of Stores
- (c). Audit of Stockyard
- (d). Audit of Technical Lab

#### **15.1 The report shall mandatorily include but not limited to the following:**

- i. Number of Non Conformance Report (NCR) issued.
- ii. Number of compliance received.
- iii. Total Non Conformance Report (NCR) pending
- iv. Status of compliance of pending NCR.

#### **16. Issuance of Completion Certificate to Contractor by Authority's Engineer**

The test results on completion including video, NSV survey report/ data and safety audit shall invariably be uploaded on the PMIS portal before issue of completion certificate by the Authority's Engineer after ascertaining that all pre-requisites as per Contract Agreement has been fulfilled by the Contractor, failing which Consultancy firm shall be debarred for a period of two year.

#### **17. Submission of MPR.**

Consultant shall record all aspects as per services to be provided in terms of Reference (ToR), failing which the Consultancy firm shall be warned for non-performance. In case the Consultancy firm continues to default, even after multiple warning exceeding 5 times, the firm shall be put on holiday listing (temporary debarment) for a period up-to 12 months from future assignments by MoRTH or its Executing Agencies

#### **18. Redressal of complaints**

Any complaint/ default which comes to the notice shall be examined by concerned Regional Officer and proposal will be submitted to Hqrs with his specific recommendation and documentary evidence. The Committee comprising of Executive Director (Technical), an Officer of the rank of Executive Director from other Zone and a representative of Finance Division will further examine the

case and give an opportunity to the Consultant for submission of his clarification. After carefully examining the matter with due diligence, the Committee will recommend deterrent action for acceptance of competent authority.

## MAN - MONTHS INPUT FOR KEY PROFESSIONAL STAFF AUTHORITY ENGINEER

## Normal Highway Project

S. No.	Key Personnel	Man-month in Construction period of 24 months	Man-month in Defect Liability Period of 60 months
<b>A: Key Personnel</b>			
1	Team Leader Cum Senior Bridge Engineer	24	6
2	Resident cum Highway Engineer (01 nos during construction and 1 during maintenance)	24	60
3	Bridge/Structural Engineer (01 no)	24	0
4	Senior Quality cum Material Expert (1 nos during construction)	24	0
5	Senior Contract Specialist	08	0
6	Road Safety Expert	18	0
	<b>Sub Total</b>	122	66
	<b>Total for Construction and Maintenance</b>	<b>188</b>	
<b>B: Sub Professional Staff</b>			
7	Survey Engineer (3nos)	24+18+18=60	0
8	Quantity Surveyor (3 nos during Construction Period and 1 no during Maintenance Period)	24+18+18=60	8
9	Lab technician (3 nos during Construction Period)	24+18+18=60	0
10	CAD Expert	12	0
11	Assistant Bridge Engineer(3 No)	24+18+18=60	60
12	Assistant Highway Engineer (3 nos)	24+18+18=60	60
	<b>Sub Total</b>	312	128
	<b>Total for Construction and Maintenance</b>	<b>440</b>	
	<b>Grand Total</b>	<b>628</b>	

**Note:**

- The other inputs like support staff shall be provided by the Consultant of an acceptable type commensurate with the roles and responsibilities of each position
- In case of project having different construction period, Man Month Input shall be adjusted proportionately
- The Financial Expert or Legal expert or Contract Specialist may be required for the project for specific needs. Their deployment shall be arranged by the Consultant on specific requisition from NHIDCL and the payment shall be made as per the actual deployment. The Financial Expert or Legal expert or Contract Specialist shall be paid at the rates quoted for Senior Pavement Specialist.

## QUALIFICATION OF KEY PERSONNEL

### **TEAM LEADER CUM SENIOR BRIDGE ENGINEER**

This is the senior most position and the expert engaged as the team leader shall be responsible for reviewing the entire Project preparation and implementation activities of the Concessionaire. He shall check all the Designs being prepared by the Concessionaire, ensure execution of works on site as per specification and standards, and continuously interact with the NHIDCL and the Concessionaire. He shall undertake Project site visits and shall guide, supervise, coordinate and monitor the work of other experts in his team as well as those of the Concessionaire. The candidate is required to be a Senior Bridge Engineer, who should have a proven record of supervising, organizing and managing of construction of Bridge projects and also of Project preparation of large magnitudes projects, as defined below, financed by international lending agencies and others. Knowledge of Project management shall be an added advantage.

He should have the following qualification / experience.

#### **1. Essential Qualifications.**

- a) Graduate in Civil Engineering from recognized university.
- b) Total Professional Experience of at least 12 years in handling Bridge Projects.
- c) At least 5 years experience as Team Leader/Project Manager or similar capacity in Highway Development Project.
- d) He should have handled as Team Leader/Project Manager or similar capacity of at least two projects in Construction Supervision / IC (of length 40% of project length or more of similar configuration (2/4/6 laning\*\*))
- e) He should have handled as Team Leader or similar capacity of at least Two projects in Construction Supervision / AE/ IE/ Project preparation involving at least one Major Bridge (minimum 300 m length without approaches) in the Project (of length 40% of project length or more of similar configuration (2/4/6 laning\*\*))
- f) Experience as Team Leader/Project Manager or similar capacity in Operation and Maintenance of Major Bridge (minimum 300 m length without approaches) in the Project (of length 40% of project length or more of similar configuration (2/4/6 laning\*\*)).

#### **1. Preferential Qualifications.**

- a) Post Graduate Degree in Structural Engineering or equivalent.
- b) Highway Development Projects (of length 40% of project length or more of similar configuration (2/4/6 laning\*\*)).
- c) Degree/Diploma/Certificate in Project Management

**Note:** (1) Similar Capacity includes the following positions

- i. On behalf of Consultant: Team Leader / Resident Engineer (Construction Supervision/IE/AE).

- ii. On behalf of Contractor : Project Manager (Construction/ Construction Supervision)  
In Government Organizations : Superintending Engineer (or equivalent) and above  
(2) Only those projects will be considered for evaluation at Sl. No. 1(d), 1(e) & 1(f) above, where the input of the personnel is 12 months, 9 months and 12 months respectively.

### **RESIDENT CUM HIGHWAY ENGINEER**

The Resident cum Highway Engineer shall be responsible for supervising the works of highway to be constructed by the Concessionaire for this project. He shall also inspect the pavement rehabilitation and repair works to be undertaken by the Concessionaire.

He should have the following qualification / experience.

#### **1. Essential Qualifications.**

- I. Graduate in Civil Engineering from a recognized University.
- II. Professional Experience of at least 12 years in Highway Projects.
- III. At least 5 years experience in similar capacity in Highway Development Project.
- IV. Should have handled at least 2 major projects(of length 40% of project length or more of similar configuration (2/4/6 laning\*\*) and above).

#### **2. Preferential Qualifications.**

- I. Post Graduate Degree in Transportation/Highway Engineering/Structural Engineering/Geotechnical Engineering/any specialised stream of Civil Engineering.
- II. Experience of Highway Project (of length 40% of project length or more of similar configuration (2/4/6 laning\*\*) and above) of Construction / Construction Supervision / IC of Highway projects

### **BRIDGE & STRUCTURAL ENGINEER**

The Bridge& Structural Engineer shall be responsible for checking the designs of bridges, ROBs, interchanges and any other structure to be constructed in the Project highway and supervising the works of bridges, interchanges and any other structure to be constructed by the Concessionaire for this project. He shall also inspect the bridge rehabilitation and repair works to be undertaken by the Concessionaire. He should have thorough understanding and experience with international 'best practices' of modern bridge construction technology.

#### **1. Essential Qualifications.**

- a) Graduate in Civil Engineering from a recognized University.
- b) Professional Experience of at least 10 years in handling Highway/Bridge projects.
- c) At least 5 years experience in Construction / Construction Supervision of bridge / interchange / any other structures/
- d) Experience in similar capacity in supervision of at least 2 Major Highway Bridges.
- e) Experience in supervision of Rehabilitation and repair of 2 nos Major Bridges

## **2. Preferential Qualifications.**

- a) Post Graduate Degree in Structural Engineering.
- b) He should have thorough understanding and experience of modern bridge construction technology. viz., Precast Segmental, Balanced Cantilever Construction, Extradosed Bridge, Full Span Launching, And Incremental Launching.

### **SENIOR QUALITY/MATERIAL EXPERT**

The Quality/Material Expert shall review the test results of bore holes, quarry and borrow area material to find out their strength characteristics and suitability for using them in Construction. He shall inspect the Concessionaire's field laboratories to ensure that they are adequately equipped and capable of performing all the specified testing requirements of the contract. He shall look into the quality assurance aspect of the construction works and supervise the setting-up of the various Concessionaire's rock crushers and bituminous mixing plants to ensure that the specified requirements for such equipment are fully met. Experience in latest Quality Management techniques in highway projects shall have added advantage.

He should have the following qualification / experience.

#### **1. Essential Qualifications.**

- a) Graduate in Civil Engineering from a recognized University.
- b) Professional Experience of at least 10 years in handling Highway projects.
- c) Experience of at least 5 years as Senior Quality/ Material Expert or in similar capacity in Construction / Construction Supervision /major highway projects
- d) Experience as Senior Quality/ Material Expert or in similar capacity in handling of at least 2 similar highway projects.(of length 40% of project length or more of similar configuration (2/4/6 laning\*\*) and above)

#### **2. Preferential Qualifications.**

Post Graduate Degree in Geotechnical Engineering / Foundation Engineering / Soil Mechanics.

### **SENIOR CONTRACT SPECIALIST**

Duties: He will be deployed in working season in stages for cumulative duration of period mentioned in Enclosure-A for obtaining his expert opinion on emerging contractual issues. His key responsibilities will be to guide and assist Team Leader/Employer in all aspects of contract management in proper implementation of contract provisions including controlling the project cost of the construction package. He will also be required to offer his advice on contractual complications arising during the implementation as per the request of the employer. He will be required to prepare manuals/schedules for the consultants team/employer based on the provisions of the contract document. He will be responsible for giving appropriate suggestions in handling claims of the contractors and any dispute arising thereof.

Essential Qualifications.

Graduate in Civil Engineering from a recognized University.

Professional Experience of 15 years in Contract Management.

Experience of at least 4 years as Contract Specialist on any National/State Highway project/Bridge Project.

Contract Management of a large Highway/Bridge contract say over Rs.150 crore including experience of handling Variation orders, claims of the contractor and there appropriate disposal for at least 2 projects.

Handled at least one Arbitration cases in respect of any Highway/Bridge projects.

Not more than 65 years of age.

Preferential Qualifications.

(a) Degree in Law/PG in management/certificate course in management/ certificate course in construction management/certificate course in contract management.

### **ROAD SAFETY EXPERT**

Shall be responsible for the overall Road Safety Aspect of the Project. He shall ensure that safety provisions as per relevant codes are strictly followed at site during Construction of Road and also during the Maintenance Period

#### **1. Essential Qualifications.**

- a) Graduate in Civil Engineering from a recognized University.
- b) Professional Experience of at least 10 years in handling Highway projects.
- c) Minimum 5 years experience in Road Safety works of Major Highway Projects (4 / 6 laning projects)
- d) Experience in similar capacity in Road Safety Audit of at least 2 nos. 2/4/6 lane\*\* highway / expressway project including 1 nos. at design stage
- e) Experience in similar capacity in the field of Road Safety Management Plan.

#### **2. Preferential Qualifications**

- a) Post Graduate Degree in Traffic Transportation/Safety Engineering.
- b) Experience in similar capacity in identification and improvement of black spots on Major Highway Project.
- c) Experience in similar capacity in Preparation of Road Safety Management Plan for inter urban Highways.

### **SUB PROFESSIONAL**

#### **SURVEY ENGINEER**

The candidate should be Graduate in Civil Engineering Firm may field Survey Engineer with diploma in Civil Engineering/Survey having at least 5 years experience in the field of surveying out of which at least 3 years should be in highway projects and they should have also dealt with at least 1 project of similar nature. This position requires thorough understanding of modern computer based method of surveying with total station digital level etc.

### **QUANTITY SURVEYOR**

He should be Graduate or equivalent in Civil Engineering having Min. 5 years of professional experience in preparation of highway project estimates. He should have Min. 3 years experience in **Preparation of Bill of Quantities/estimates for major highway projects costing Rs.100 Crore or above.**

### **LAB TECHNICIAN**

He should be Graduate or equivalent in Civil Engineering or diploma in Civil Engineering/ having at least 5 years experience as a Lab Technician.

### **ASSISTANT HIGHWAY ENGINEER**

The Candidate should be Graduate in Civil Engineering.

### **ASSISTANT BRIDGE ENGINEER**

The Candidate should be Graduate in Civil Engineering with 3 years experience. He should have handled at least 1 major bridge project.

### **CAD Expert**

He should be Graduate in Civil Engineering/Computer Science having experience in computer related design method for highway engineering.

### **Annexure I- Daily Inspection Report in construction period**

<b>Component</b>	<b>Item Description</b>	<b>Description of inspection work carried out</b>	<b>Results of lab tests conducted (Test conducted, Pass/Fail)</b>	<b>Name of key personnel inspecting the work</b>
1. Road works including culverts, and minor bridges	Embankment/ Sub Grade/ GSB/ WMM/ DBM/ BC			
2. Major Bridge works, Flyovers, ROB, RUB, VUP, PUP	Foundation/ Sub structure/ Super structure			
3. Approach to ROB/RUB/ Major Bridges/ Viaduct /RE wall	Foundation/ Sub structure/ Super structure			
4. Other Works				

**Annexure II- Daily Inspection Report in O&M period**

Nature of defect/ deficiency	Defect found (Yes/No)	If defect found, Chainage & side	Compliance of previous defect (Yes/No/NA)	AE Remarks
<b>ROADS</b>				
<b>Carriageway and paved shoulders</b>				
Breach or blockade				
Pot holes				
Removal of debris				
<b>Hard/earth shoulders, side slopes, drains and culverts</b>				
Desilting of drains in urban/semi-urban areas				
<b>Road side furniture including road signs and pavement marking</b>				
Damage to shape or position; poor visibility or loss of retro-reflectivity				
<b>Street lighting and telecom (ATMS)</b>				
Any major failure of the system				
Faults and minor failures				
<b>Trees and Plantation</b>				
Obstruction in a minimum head-room of 5m above carriageway or obstruction in visibility of road signs				
<b>Rest areas</b>				
Cleaning of toilets				
Defects in electrical, water and sanitary installations				
<b>Toll plaza[s]</b>				
Failure of toll collection equipment including ETC or lighting				
<b>Other Project Facilities and Approach roads</b>				
Damage or deterioration in Approach Roads, -[pedestrian facilities, truck lay-bys, bus-bays, bus-shelters, cattle crossings, Traffic Aid Posts, Medical Aid Posts and other works]				

**Annexure III- Weekly Inspection Report in O&M period**

Nature of defect or deficiency		Defect found (Yes/No)	If defect found, Chainage & side	Compliance of previous defect (Yes/No/NA)	AE Remarks
<b>ROADS</b>					
<b>(a)</b>	<b>Carriageway and paved shoulders</b>				
(i)	Breach or blockade				
(ii)	Roughness value exceeding 2,500 mm in a stretch of 1 km (as measured by a standardised roughometer/bump integrator)				
(iii)	Pot holes				
(iv)	Cracking in more than 5% of road surface in a stretch of 1 km				
(v)	Rutting exceeding 10mm in more than 2% of road surface in a stretch of 1 km (measured with 3 m straight edge)				
(vi)	Bleeding/skidding				
(vii)	Ravelling/Stripping of bitumen surface exceeding 10 sq m				
(viii)	Damage to pavement edges exceeding 10 cm				
(ix)	Removal of debris				
<b>(b)</b>	<b>Hard/earth shoulders, sideslopes, drains and culverts</b>				
(i)	Variation by more than 2% in the prescribed slope of camber/cross fall				
(ii)	Edge drop at shoulders exceeding 40 mm				
(iii)	Variation by more than 15% in the prescribed side (embankment) slopes				
(iv)	Rain cuts/gullies in slope				
(v)	Damage to or silting of culverts and side drains during and immediately preceding the rainy				

	season				
(vi)	Desilting of drains in urban/semi- urban areas				
<b>(c)</b>	<b>Roadside furniture including road signs and pavement marking</b>				
(i)	Damage to shape or position; poor visibility or loss of retro- reflectivity				
<b>(d)</b>	<b>Street lighting and telecom (ATMS)</b>				
(i)	Any major failure of the system				
(ii)	Faults and minor failures				
<b>(e)</b>	<b>Trees and plantation</b>				
(i)	Obstruction in a minimum head-room of 5 m above carriageway or obstruction in visibility of road signs				
(ii)	Deterioration in health of trees and bushes				
(iii)	Replacement of trees and bushes				
(iv)	Removal of vegetation affecting sight line and road structures				
<b>(f)</b>	<b>Rest areas</b>				
(i)	Cleaning of toilets				
(ii)	Defects in electrical, water and sanitary installations				
<b>(g)</b>	<b>Toll plaza[s]</b>				
(i)	Failure of toll collection equipment including ETC or lighting				
(ii)	Damage to toll plaza				
<b>(h)</b>	<b>Other Project Facilities and Approach roads</b>				
(i)	Damage or deterioration in Approach Roads, -[pedestrian facilities, truck lay-bys, bus-bays, bus- shelters, cattle crossings, Traffic Aid Posts, Medical Aid Posts and other works]				

<b>BRIDGES</b>				
<b>(a)</b>	<b>Superstructure of bridges</b>			
(i)	Cracks			
(ii)	Spalling/scaling			
<b>(b)</b>	<b>Foundations of bridges</b>			
(i)	Scouring and/or cavitation			
<b>(c)</b>	<b>Piers, abutments, return walls and wing walls of bridges</b>			
(i)	Cracks and damages including settlement and tilting			
<b>(d)</b>	<b>Bearings (metallic) of bridges</b>			
(i)	Deformation			
<b>(e)</b>	<b>Joints in bridges</b>			
(i)	Loosening and malfunctioning of joints			
<b>(f)</b>	<b>Other items relating to bridges</b>			
(i)	Deforming of pads in elastomeric bearings			
(ii)	Gathering of dirt in bearings and joints; or clogging of spouts, weep holes and vent-holes			
(iii)	Damage or deterioration in parapets and handrails			
(iv)	Rain-cuts or erosion of banks of the side slopes of approaches			
(v)	Damage to wearing coat			
(vi)	Damage or deterioration in approach slabs, pitching, apron, toes, floor or guide bunds			
(vii)	Growth of vegetation affecting the structure or obstructing the waterway			

#### **Annexure IV- Month of survey for equipment based road condition assessment**

Equipment based road inspection shall be done by the Authority's Engineer twice a year as per the month of the year defined in the following table.

However, since the first survey shall be conducted at the time of completion testing, the following modification to the schedule shall be adopted. For example, if majority of highway length (>50%) passes through a state, where defined survey months are May and November, if completion testing is conducted in April, then the first equipment based survey shall be conducted in the month of April. This shall be considered as the equipment based survey to be conducted in the month of May. The 2<sup>nd</sup> equipment based survey shall be conducted in the month of November; the 3<sup>rd</sup> survey shall be conducted in the month of May and so on. As regards FWD, the first test/survey shall be conducted at the time of completion in April. The 2<sup>nd</sup> test/survey shall be conducted in April of next year and so on.

Region	State	Survey before rains	Survey after rains
East	Bihar	May	Nov
East	Chhattisgarh	May	Nov
East	Jharkhand	May	Nov
East	Orissa	May	Nov
East	West Bengal	May	Nov
Central	Madhya Pradesh	May	Nov
NE	Arunachal Pradesh	Mar	Oct
NE	Assam	Mar	Oct
NE	Manipur	Mar	Oct
NE	Meghalaya	Mar	Oct
NE	Mizoram	Mar	Oct
NE	Nagaland	Mar	Oct
NE	Sikkim	Mar	Oct
NE	Tripura	Mar	Oct
North	Chandigarh	May	Nov
North	Delhi	May	Nov
North	Haryana	May	Nov
North	Himachal	May	Nov
North	Jammu And Kashmir	May	Nov
North	Punjab	May	Nov
North	Uttar Pradesh	May	Nov
North	Uttaranchal	May	Nov

South	Andaman And Nicobar Islands	Apr	Nov
South	Andhra Pradesh	Apr	Nov
South	Karnataka	Apr	Nov
South	Kerala	Apr	Nov
South	Pondicherry	Jun	Jan
South	Tamil Nadu	Jun	Jan
West	Dadar Nagar Haveli	Apr	Oct
West	Daman And Diu	Apr	Oct
West	Goa	May	Nov
West	Gujarat	Apr	Oct
West	Maharashtra	May	Nov
West	Rajasthan	Apr	Oct

**Annexure V- Monthly Progress Report in Construction Phase**

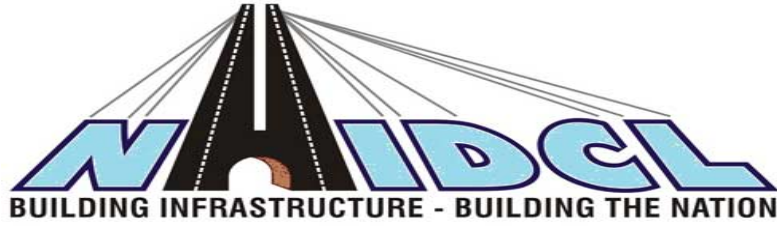

[NAME & LOGO OF NHIDCL]

PROJECT NAME

Authority Engineer

[NAME OF CONSULTING FIRM] MONTHLY PROGRESS

REPORT NO. [XX] FOR THE MONTH OF: [MONTH],  
[YEAR]

## Table of content

S. No	CONTENT	PAGE NO
1	Executive Summary	
1.1	Construction progress in current month	
1.2	Current issues and recommended actions by IE / AE	
1.3	Strip Plan (Summary)	
1.4	Strip Plan (Details)	
2	Project Overview	
2.1	Salient Features of Project	
2.2	Project Milestones	
2.3	Location Map	
2.4	Key Plan	
3	Critical Issues & Action Log	
3.1	Pending Issues & Action Log	
3.2	Obligations as per Contract	
4	Physical Progress	
4.1	Detailed Scope of Work & Physical Progress by Component	
5	Land Acquisition and Clearance	
5.1	LA Summary	
5.2	LA Detail by CALA	
5.3	LA Detail by Village for each CALA	
5.4	Manpower details of CALA	
5.5	Clearances Summary	
5.6	Status of utilities shifting	
6	Change of Scope	
7	Mobilization of Resources	
8	Financial Progress Details (for PPP projects)	
8.1	Pen Picture - Escrow	
8.2	Escrow details	
9	Summary of quality control tests	
9.1	Tests witnessed by IE/ AE	
9.2	Tests conducted by IE / AE	

<b>10</b>	Monitoring of maintenance obligations during construction phase	
<b>10.1</b>	Critical issues and action log	
<b>10.2</b>	Summary of repair work	
<b>10.3</b>	Status of damages	
<b>11</b>	Safety features	
<b>11.1</b>	Pen picture of safety features	
<b>11.2</b>	Accident Report	
<b>12</b>	Annexures	

## 1 Executive Summary

### 1.1 Construction progress in current month

Key reporting metrics	Value/ %/ Amount
Scheduled Physical Progress (%)	
Cumulative Physical Progress up-to current month (%)	
Physical Progress during current month (%)	
Financial progress (%)	
Cumulative Expenditure till date (Rs Cr)	
Tests passed as % of total tests witnessed by IE	
Tests passed as % of total tests conducted by IE	
Number of pending COS proposals	
Amount for pending COS (Rs Cr)	

### 1.2 Current issues and recommended actions by IE / AE

1. Slow Progress of Structures: The progress of structures (especially, major bridges, flyovers and ROB's) is very slow. Overall progress is only XX%. Out of the total YY underpasses not even single underpass structure and its approaches is completed so far. No bridge is open to traffic so far.

**a** *Recommendation: Concessionaire should improve the progress of structures. Request for revised work plan from Concessionaire including specific activities on structures.*

2. Status of Change of Scope Proposals: Concessionaire has submitted Xx No. Change of Scope proposals. Yy No. of them is still pending for decision. Concessionaire has not submitted necessary clarifications /details for the following Changes of Scope in spite of several reminders.

**a** *Recommendation: Concessionaire to submit all pending clarifications to Authority. Authority and Concessionaire to expedite pending COS proposals.*

### 1.3 Strip Plan (Summary)

#### 1. Work front Unavailable & reason for Unavailability

#### 2. Length completed by layer (MCW)

#### 3. Length completed by layer (Service Road)

	Length (km)	% Total Pending Length		Length (km)	% Total Length		Length (km)	% Total Length
<b>Total Length</b>			<b>Total Length</b>			<b>Total Length</b>		
<b>Total Workfront Unavailable</b>			<b>Total Length Completed (Till DBM)</b>			<b>Total Length Completed (Till DBM)</b>		
<b>Pending Land Acq.</b>			<b>BC</b>			<b>BC</b>		
<b>Pending Clearances</b>			<b>DBM</b>			<b>DBM</b>		
<b>Encumbrances</b>			<b>WMM</b>			<b>WMM</b>		
			<b>GSB</b>			<b>GSB</b>		
			<b>Sub-Grade</b>			<b>Sub-Grade</b>		
			<b>C&amp;G</b>			<b>C&amp;G</b>		



## Detailed report

### 2 Project Overview

#### 2.1 Salient Features of Project

<b>Project Name</b>	
<b>NH No. (New/ Old)</b>	
<b>Scheme/ Phase</b>	
<b>Mode of the Execution (BOT Toll/ BOT Annuity/ EPC/ HAM/ Item Rate/ Others)</b>	
<b>No. of Lanes/ Configuration</b>	
<b>Length of the Project (in Km)</b>	
<b>Total Project Cost (in Cr)</b>	
<b>No. of Bypasses (Name of Town, Length)</b>	
<b>No. of Major Bridges (Number and Location)</b>	
<b>No. of Toll Plazas (Number and Location)</b>	
<b>No. of Fly Overs (Number and Location)</b>	
<b>DPR Authority's Engineer Name</b>	
<b>Lead &amp; Consortium Members of Banks</b>	
<b>Contractor Name (SPV &amp; Parent Company)</b>	
<b>Date of Award (LOA Date)</b>	
<b>Appointed Date</b>	
<b>Concession Period</b>	
<b>Construction Period (in Days)</b>	
<b>O&amp;M Period (in Days)</b>	
<b>Scheduled Date of Completion</b>	
<b>Authority Engineer</b>	
<b>IE / AE Agreement Date</b>	
<b>IE / AE Mobilization Date</b>	

ALL FIGURES & GRAPHS IN TEMPLATES ARE ILLUSTRATIVE. PLEASE ADD ACTUAL DETAILS

## 2.2 Project Milestones

Project Milestone	Description (Days from Appointed Date)	Planned		Actual		Delay (No. of months)	Current Status
		Physical Progress (%)	Scheduled Date	Physical Progress (%)	Revised Date		
Milestone I	[Description]	25	[DD/MM/YYYY ]	25	[DD/MM/YYYY ]	5	Achieved
Milestone II	[Description]	65	[DD/MM/YYYY ]		[DD/MM/YYYY ]	22	Started, not achieved
Scheduled Completion	[Description]	100	[DD/MM/YYYY ]		[DD/MM/YYYY ]	21	Not started

### 2.3 Location Map

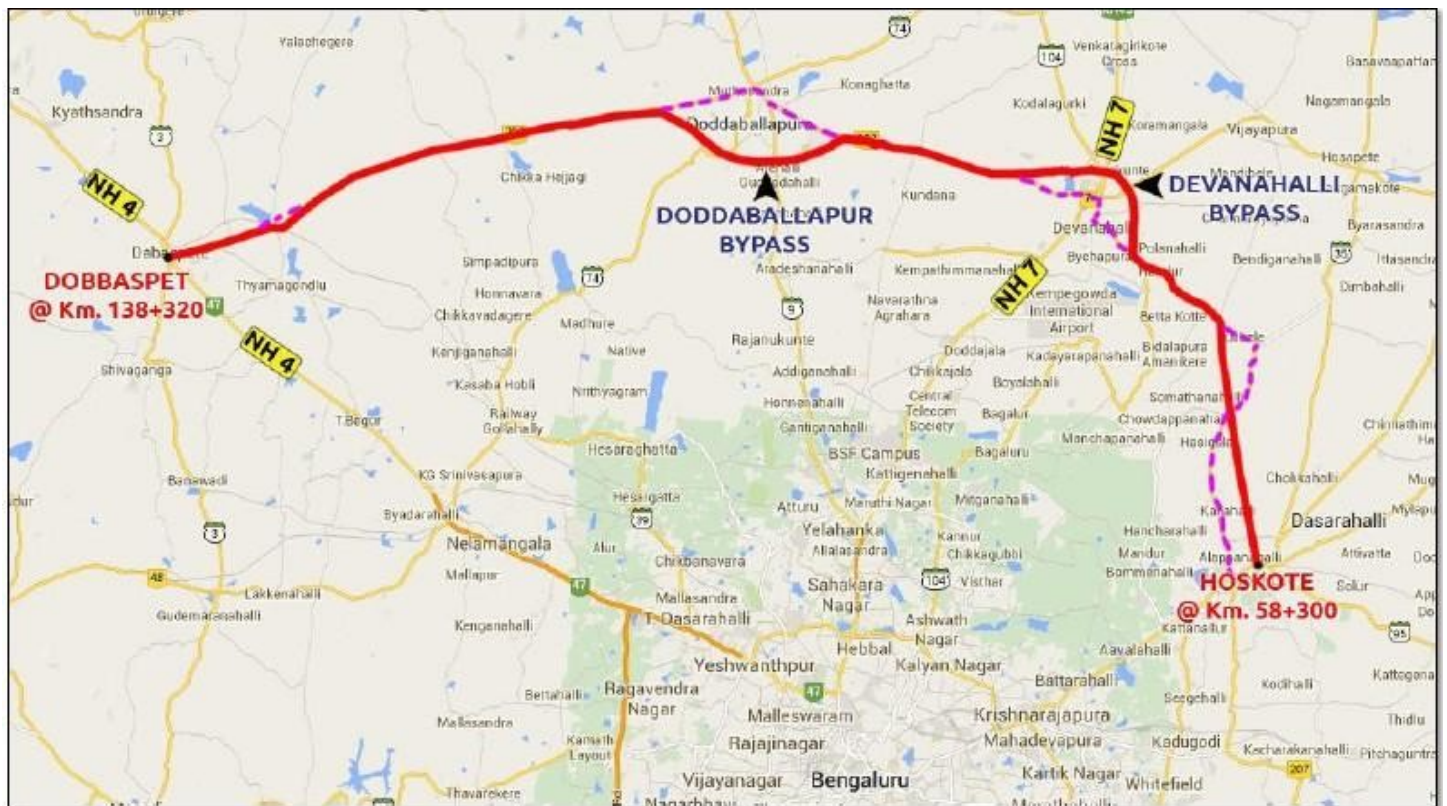

2.4 Key Plan

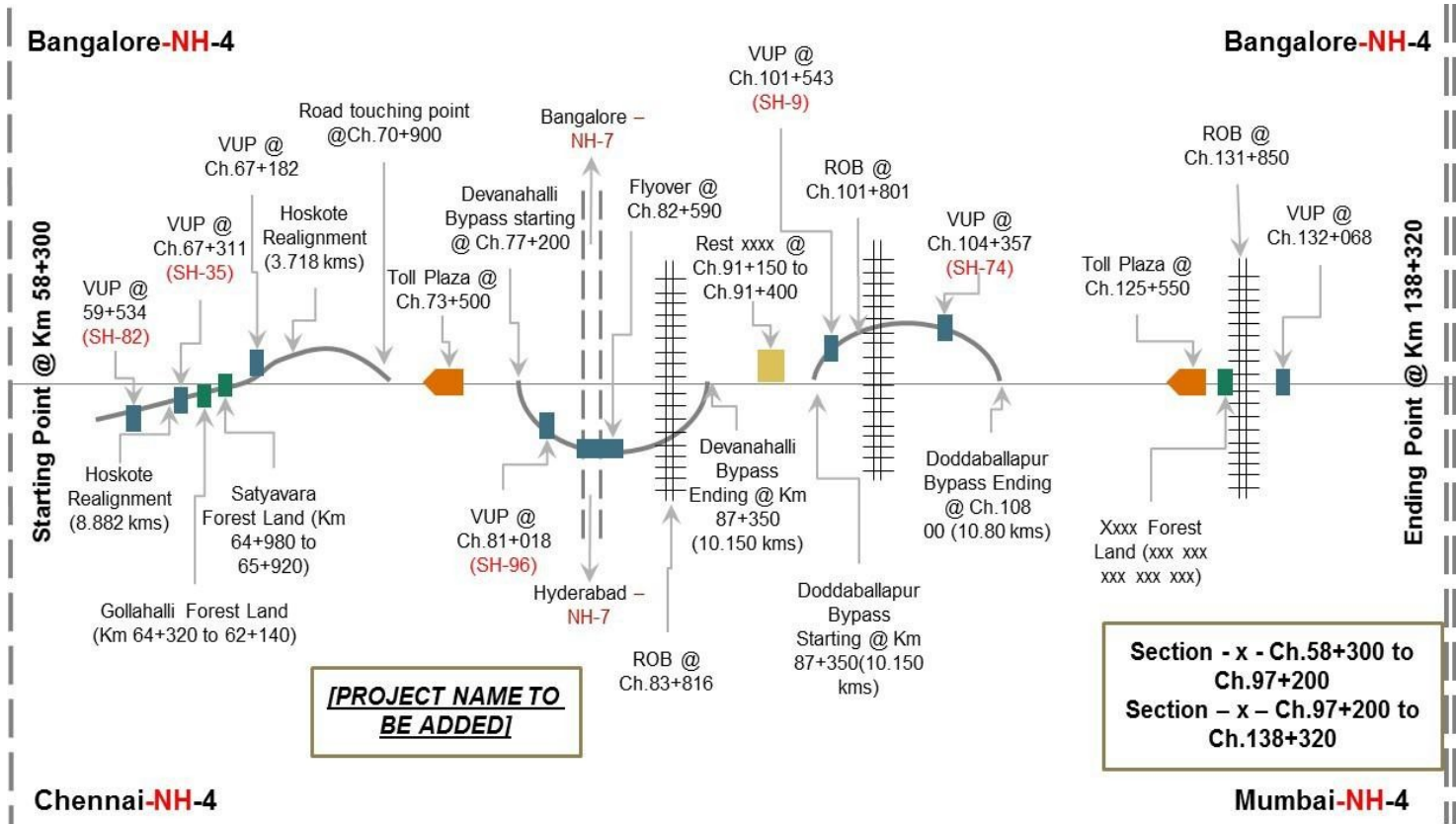

[Above image is illustrative only. Please include chainage and name below the axis and list of features above the axis]

### 3. Critical Issues & Action Log

#### 3.1 Pending Issues & Action Log

S.No	Issue Description	Type	Ongoing/ New Issue/ Resolved	Concerned Authority	Chainage(s) affected due to the issue	Length affected (km)	Action(s) taken till now	Action(s) suggested by the AE	Expected date/ Actual Date for resolving issue
1	<b>Diversion of Xx ha of forest Land</b>	Clearance	<b>Ongoing Issue</b>	MoEF	[Chainage]	4 kms	1. Proposal submitted to MoEF Letter sent by RO to MoEF nodal officer on [DD/MM/YYYY]	Escalate to higher level officers at MoEF	[DD/MM/YYYY]
2	<b>21 Cr compensation disbursement pending</b>	Land Acquisition	<b>Resolved</b>	[CALA Name]	[Chainage]	2.4 km	1. Escalated to chief secretary level through DO from Chairman/ Secretary, dated [DD/MM/YYYY]		[DD/MM/YYYY]
3	<b>Slow progress by concessionaire</b>	Concessionaire Issue	<b>New Issue</b>	[Concess. Name]	[Chainage]	57 km	None	Project Director to call higher ups of concessionaire	[DD/MM/YYYY]

### 3.2 Obligations as per Contract

<b>Expected Contents &amp; Structure</b>
<p><i>Please write a summary of non-compliances of contractual obligations highlighting reasons for delay, stating pending actions and their potential risk to the project's progress and recommended actions by the IE.</i></p> <ul style="list-style-type: none"> <li>□ <b><u>Critical</u> obligation sand constraints of concessionaire as per contract</b></li> <li>□ <b><u>Critical</u> obligations of authority as per contract</b></li> <li>□ <b><u>Critical</u> pending obligations of IE as per contract</b></li> </ul> <p><b><i>NOTE: Please include important issues requiring intervention of various parties, giving details and background wherever necessary</i></b></p>

ALL FIGURES & GRAPHS IN TEMPLATES ARE ILLUSTRATIVE. PLEASE ADD ACTUAL DETAILS

### 4 Physical Progress

Component	% Weightage	Physical Progress(During Current Month)	Physical Progress (Cumulative, Upto Current Month)
Road Works	35.00%	5%	15.0%
Major Bridge works and ROB/RUB	40.00%	1.20%	26.2%
Structures	21.00%	0.00%	0.8%
Other Works	4.00%	0.00%	0.0%
<b>Physical Progress</b>		<b>2%</b>	<b>42.0%</b>

#### 4.2 Detailed Scope of Work & Physical Progress by Component

Component	Cost Weightage in Project (%)	Item Description	Cost Weightage in Component (%)	Planned in Scope (As per Scope of Work)	Progress till Date	%Physical Progress	Value of Physical Progress (7X4)
1	2	3	4	5	6	7	8
<b>1. Road works including culverts, minor bridges, underpasses, overpasses, approaches to ROB/RUB/ Major Bridges/ Structures (but excluding service roads)</b>							
<b>2. Major Bridge works and ROB/RUB</b>							
<b>3. Structures (elevated sections, reinforced earth)</b>							
<b>4. Other Works</b>							
<b>GRAND TOTAL</b>							

## 5 Land Acquisition and Clearance 5.1 LA

### Summary

Description	Total Required (ha)	Total in possession at start (ha)	Total to be acquired (ha)
Existing ROW			
Pvt. Land To be Acquired			
Public Land To be Transferred			
Grand Total			

### 5.2 LA Detail by CALA

CALA	Total Land left to be	3H Pending (ha)	3H Done (ha)	3G Pending (ha)	3G Done (ha)	3D Pending (ha)	3D Done (ha)	3A Pending (ha)	3A Done (ha)	Amount Awarded (Crore Rs.)	Amount Deposited (Crore Rs.)	Amount Disbursed by CALA (Crore Rs.)	Pending Amount (Crore Rs.)
CALA 1]													
[CALA2]													
[CALA 3]													
Grand Total													

### 5.3 LA Detail by Village for each CALA CALA 1

Village	Total Land left to be Acquired (Ha)	3H Pending (ha)	3H Done (ha)	3G Pending (ha)	3G Done (ha)	3D Pending (ha)	3D Done (ha)	3A Pending (Ha)	3A Done (ha)	Amount Awarded (Crore Rs.)	Amount Deposited (Crore Rs.)	Amount Disbursed by CALA (Rs Cr)	Pending Amount (Rs Cr)
[Village 1]													
[Village 2]													
[Village 3]													
Grand Total													

ALL FIGURES & GRAPHS IN TEMPLATES ARE ILLUSTRATIVE. PLEASE ADD ACTUAL DETAILS

**5.4 Manpower details of CALA**

CALA	Provided by NHIDCL / State Govt	Amins/ Surveyors	Patwaris/ Village accountant	Revenue Inspectors/ Kanung	Tehsildars/ Dep. Tehsildars	Clerks/ Sahayaks	Accountants	Computer operators	Peons	Chainman	Total
[CALA 1]											
[CALA 1]											
[CALA 2]											
[CALA 2]											
Grand Total											

**5.5 Clearances Summary**

Environment				
Proposal Description	Status	Length Impacted	Current Stage	Issues/ Comments
Forest Land				
Proposal Description	Status	Length Impacted	Current Stage	Issues/ Comments

<b>Wildlife</b>				
<b>Proposal Description</b>	<b>Status</b>	<b>Length Impacted</b>	<b>Current Stage</b>	<b>Issues/ Comments</b>
<b>Tree Cutting</b>				
<b>Proposal Description</b>	<b>Status</b>	<b>Length Impacted</b>	<b>Current Stage</b>	<b>Issues/ Comments</b>
<b>Railway (ROBs/RUBs)</b>				
<b>Proposal Description</b>	<b>Status</b>	<b>Length Impacted</b>	<b>Current Stage</b>	<b>Issues/ Comments</b>

**5.6 Status of utilities shifting**

Utility Category	Name	Status	Length affected	Department	Date of request by Authority for estimate	Date when Estimate was Received from concerned dept.	Date of Approval by Authority RO/ HQ	Date of Deposit of supervision charge	Progress of Physical Shifting	Date of Certification from Agency for Completion	Estimate Amount	Issue / Comments
Water												
Electricity												
Others												

**6 Change of Scope**

S No.	Proposal Details	Date of first submission to AE	Current Status	COS Amount	ed/ Actual Date of Approval
1					
2					

**7 Mobilization of Resources**

S No.	Equipment Name	Make	Model	Age of Equipment	Planned/Required Quantity	Actual Quantity	Deployed During the Month	Reason(s) for Under/Over Mobilization	Expected Delay due to Under-Mobilization	Remarks

**8 Financial Progress Details (for PPP projects)**

**8.1 Pen Picture - Escrow**

TPC (Cr)	Cumulative inflow to Escrow till previous month (Cr)	Cumulative outflow from Escrow till previous month (Cr)	Inflow to Escrow during the month (Cr)	Outflow from Escrow during the month (Cr)

Are the Escrow withdrawals in accordance with the order of withdrawal as specified in the Concession Agreement?

Tick as applicable

ALL FIGURES & GRAPHS IN TEMPLATES ARE ILLUSTRATIVE. PLEASE ADD ACTUAL DETAILS

If not, details to be provided below:

**8.2 Escrow details**

TPC (Cr)	Cumulative exp. till date (Cr)	Escrow Plan till date- Debt (BOT)(Cr)	Escrow Plan till date- Equity (BOT) (Cr)	Escrow Plan till date- VGF (BOT) (Cr)	Escrow Actual till date- Debt (BOT) (Cr)	Escrow Actual till date- Equity (BOT) (Cr)	Escrow Actual till date- VGF (BOT) (Cr)

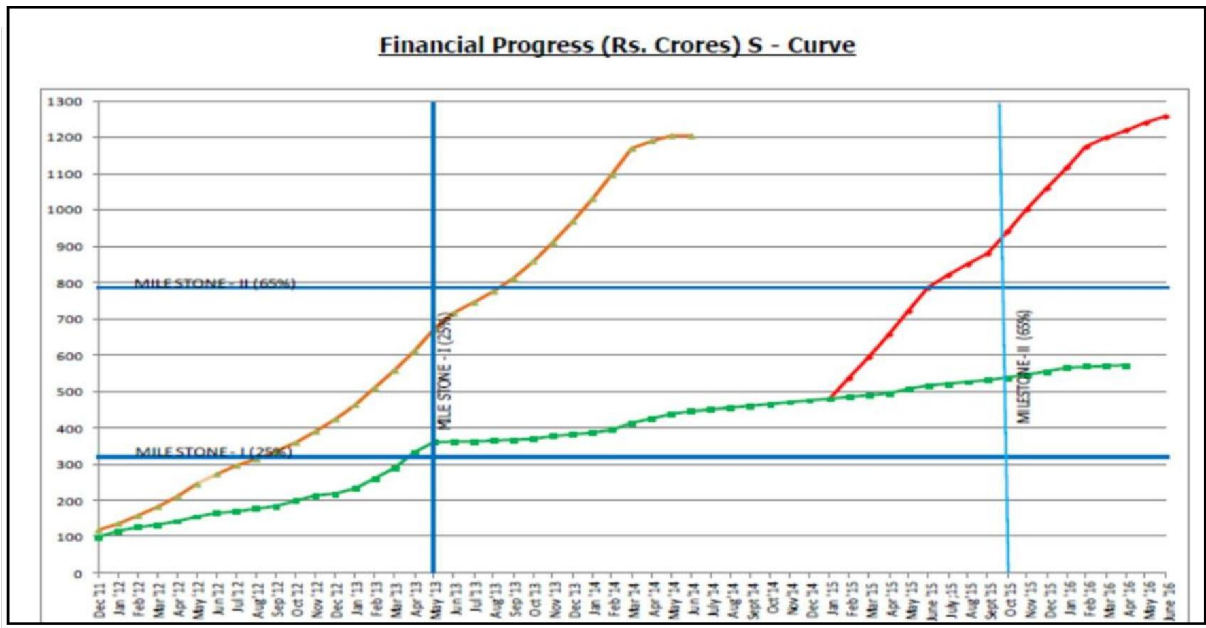

- Cum. Scheduled Progress (Original Program)
- Cum. Scheduled Progress (New Program)
- Cum. Achieved Progress



PLEASE EXCLUDE OUTSTANDING MOBILIZATION FEE/ADVANCE IN S-CURVE

**9 Summary of quality control tests 9.1 Tests witnessed by IE/ AE**

Description	Frequency of tests		Unit	Total test up to Previous Month			Total test in This Month			Cumulative No. of tests			Remarks
	Nos.	Qty.		Conducted	Pass	Fail	Conducted	Pass	Fail	Conducted	Pass	Fail	
<b>Sub grade</b>													
<b>Granular Sub Base</b>													
<b>Wet Mix Macadam</b>													
<b>Filter material</b>													
<b>Concrete</b>													
<b>Cement</b>													
<b>Water</b>													
<b>Prime Coat</b>													
<b>Tack coat</b>													
<b>Dense Bituminous Macadam</b>													
<b>Bituminous Concrete</b>													
<b>Bitumen test</b>													
<b>DLC</b>													
<b>Steel</b>													

## 9.2 Tests conducted by IE / AE

<Quality inspection test results to be reported in a table similar to the table provided in previous section>

ALL FIGURES & GRAPHS IN TEMPLATES ARE ILLUSTRATIVE. PLEASE ADD ACTUAL DETAILS

## 10 Monitoring of maintenance obligations during construction phase 10.1 Critical issues and action log

SNo	Issue Description	Ongoing/New Issue	Concerned Authority	Chainage(s) affected due to the issue	Length affected (km)	Action(s) taken till now	Action(s) suggested by SC	Expected Date for resolving issue
1	Drying up of plants on median							
2	Large potholes							

## 10.2 Summary of repair work

SNo	Description	Unit	Total	Work done upto previous month	Work done during reporting month	Balance	Remarks
<b>1</b>	<b>Carriageway and paved shoulders</b>						
(a)	Pot Holes	Sqm					
(b)	Roughness value exceeding 2,500mm	mm					
(c)	Cracking in more than 5% of road surface	Sqm					
(d)	Rutting exceeding 10mm in more than 2% of road surface	Sqm					
(e)	Bleeding/Skidding	Sqm					
(f)	Ravelling	Sqm					
(g)	Damage to pavement edges exceeding 10cm	m					
<b>2</b>	<b>Hard/Earth Shoulders</b>						

SNo	Description	Unit	Total	Work done upto previous month	Work done during reporting month	Balance	Remarks
(a)	Rain cuts/ gullies in slope	Cum					
(b)	Edge drop at shoulders exceeding 40 mm	m					
<b>3</b>	<b>Drains and culverts</b>						
(a)	Cleaning of Culvert	Nos					
(b)	Damage to or silting of culverts						
(c)	Silting of drains in urban/ semi urban areas						
<b>4</b>	<b>Road furniture</b>						
(a)	Sign Boards	Nos					
(b)	Kilometer Stones						
(c)	Metal Beam Crash						
(d)	Bus Shelters	Nos					
(e)	Junction signs	Nos					
(f)	Median Grills	Rmt					
(g)	Studs	Nos					
(h)	Delinators	Nos					
(i)	Road Marking	Sqm					
(j)	Kerb Painting	Sqm					
(k)	Guard Posts	Nos					
<b>5</b>	<b>Street lighting and telecom (ATMS)</b>						
(a)	Street lights	Nos					
(b)	Telecom	Nos					
<b>6</b>	<b>Trees and plantation</b>						
(a)	Removal of vegetation affecting sight line and road structures	Ha					
(b)	Replacement of trees and bushes	Nos					

SNo	Description	Unit	Total	Work done upto previous month	Work done during reporting month	Balance	Remarks
<b>7</b>	<b>Buildings and bridges</b>						
(a)	Rest areas						
(b)	Toll plazas						
(c)	Bridges						

### 10.3 Status of damages

SNo	Period	Amount of damages (Rs)
1		
2		
3		
4		
	<b>Total</b>	

## 11 Safety features

### 11.1 Pen picture of safety features

Details to be provided after assessment of the site requirement vis-à-vis provisions in the Concession Agreement:

Location of Black Spots	Suggested Remedial Measures within provisions of Concession Agreement	Additional Remedial Measures (if any)	Financial implications of additional Remedial Measures for Authority(Cr.)

**11.2 Accident Report**

		<b>S No</b>	
		<b>Date</b>	
		<b>Chainage no</b>	
		<b>Time of accident</b>	
		<b>Sex (M/F)</b>	
		<b>Accident location</b>	<b>A</b>
		<b>Nature of accident</b>	<b>B</b>
		<b>Classification of</b>	<b>C</b>
		<b>Causes</b>	<b>D</b>
		<b>Load conditions of</b>	<b>E</b>
		<b>Road condition</b>	<b>F</b>
		<b>Intersection type of</b>	<b>G</b>
		<b>Weather condition</b>	<b>H</b>
		<b>Age of victim</b>	<b>I</b>
		<b>Type of victim</b>	<b>J</b>
		<b>Type of vehicle</b>	<b>K</b>
		<b>Fatal</b>	<b>No of person affecte d</b>
		<b>Major</b>	
		<b>Minor</b>	
		<b>Help provided by</b>	

### Mapping of report fields to responses

A	1. Urban 2. Rural
B	1. Overturned 2. Head On Collision 3. Hit from Back 4. Hit to Fix Object 5. Right turn Collision
C	1. Fatal 2. Major injury 3. Minor injury
D	1. Drunken 2. Over Speeding 3. Vehicle out of Control 4. Driven on wrong side 5. Mechanical Problem 6. Drowsiness/Not Applicable 7. Fault of Driver
E	1. Normally Loaded 2. Overloaded/Handing 3. Empty 4. Unknown
F	1. Straight road 2. Slight Curve 3. Sharp Curve 4. Hump 5. Dip
G	1. T-Junction 2. Y-Junction 3. Four arm Junction 4. Staggered Junction 5. Junction with more than 6. Round about
H	1. Fine/Clear 2. Mist/Fog 3. Cloudy 4. Light Rain 5. Heavy Rain 6. Strong Wind 7. Dust Storm 8. Cold 9. Hot
I	1. 0-18 Years 2. 18-25 Years 3. 25-40 Years 4. 40-60 Years 5. 60-80 Years
J	1. Driver 2. Passenger 3. Pedestrian 4. Cyclist 5. Others
K	1. Two Wheeler 2. Auto Rickshaw 3. Car/Jeep 4. Bus 5. Light Truck 6. Heavy Truck 7. Tractor 8. Bicycle 9. Cycle Rickshaw 10. Hand Drawn Cart 11. Animal Drawn Cart

Annex 1. Detailed List of Physical Components as per Schedule G

Component	Physical Item
Road works including culverts, minor bridges, underpasses, overpasses, approaches to ROB/RUB/ Major Bridges/ Structures (but excluding service roads)	<b>A- Widening and strengthening of existing road</b>
	(1) Earthwork up to top of the sub-grade
	(2) Granular work (sub- base, base, shoulders)
	(a) GSB
	(b) WMM
	(3) Shoulders
	(4) Bituminous work
	(a) DBM
	(b) BC
	(5) Rigid Pavement
	Concrete work
	(6) Widening and repair of culverts
	(7) Widening and repair of minor bridges
	<b>B- New realignment/bypass</b>
	(1) Earthwork up to top of the sub-grade
	(2) Granular work (sub- base, base, shoulders)
	(a) GSB
	(b) WMM
	(3) Shoulders
	(4) Bituminous work
	(a) DBM
	(b) BC
	(5) Rigid Pavement
	Concrete work
	<b>C-New culverts, minor bridges, underpasses, overpasses on existing road, realignments, bypasses:</b>
	(1) Culverts
	(2) Minor bridges
	(a) Foundation
	(b) Sub-structure
	(c) Super-structure (including crash barriers etc. complete)
	(3) Cattle/Pedestrian underpasses
	(a) Foundation
	(b) Sub-structure
(c) Super-structure (including crash barriers etc. complete)	
(4) Pedestrian overpasses	
(a) Foundation	
(b) Sub-structure	
(c) Super-structure (including crash barriers etc. complete)	
(5) Grade separated structures	
(a) Underpasses	

Component	Physical Item	
	(i) Foundation	
	(ii) Sub-structure	
	(iii) Super-structure (including crash barriers etc. complete)	
	(b) Overpass	
	(i) Foundation	
	(ii) Sub-structure	
	(iii) S	
	(c) Flyover	
	(i) Foundation	
	(ii) Sub-structure	
	(iii) Super-structure (including crash barriers etc.	
	(d) Foot over Bridge	
	<b>Major Bridge works and ROB/RUB</b>	<b>A- Widening and repairs of Major Bridges</b>
(1) Foundation		
(a) Open Foundation		
(b) Pile Foundation/Well Foundation		
(2) Sub-structure		
(3) Super-structure (including crash barriers etc. complete)		
<b>B- Widening and repair of</b>		
(a) ROB		
(1) Foundation		
(2) Sub-structure		
(3) Super-structure (including crash barriers etc.		
(b) RUB		
(1) Foundation		
(2) Sub-structure		
(3) Super-structure (including crash barriers etc. complete)		
<b>C- New Major Bridges</b>		
(1) Foundation		
(a) Open Foundation		
(b) Pile Foundation/Well Foundation		
(2) Sub-structure		
(3) Super-structure (including crash barriers etc.		
<b>D- New rail-road bridges</b>		
(a) ROB		
(1) Foundation		
(2) Sub-structure		
(3) Super-structure (including crash barriers		
(b) RUB		
(1) Foundation		
(2) Sub-structure		
(3) Super-structure (including crash barriers etc.		
<b>Structures (elevated sections, reinforced earth)</b>		<b>(1) Foundation</b>
		<b>(2) Sub-structure</b>
	<b>(3) Super-structure (including crash barriers etc. complete)</b>	

Component	Physical Item
	<b>(4) Reinforced Earth Wall (includes Approaches of ROB, Underpasses, Overpasses, Flyover etc.</b>
	<b>(i) Service roads/ Slip Roads</b>
	<b>(ii) Toll Plaza</b>
	<b>(iii) Road side drains</b>
	<b>(iv) Road signs, markings, km stones, safety devices, ....</b>
	<b>(a) Road signs, markings, km stones, ....</b>
	<b>(b) Concrete Crash Barrier/ W-Beam Crash Barrier in Road work</b>
	<b>(v) Project facilities</b>
	<b>(a) Bus bays</b>
	<b>(b) Truck lay-byes</b>
	<b>(c) Rest areas</b>
	<b>(vi) Repairs to bridges/structures</b>
	<b>(vii) Road side plantation</b>
	<b>(viii) Protection works</b>
	<b>(a) Boulder Pitching on slopes</b>
	<b>(b) Toe/Retaining wall</b>
	<b>(ix) Tunnel</b>
	<b>(a) Excavation</b>
	<b>(b) Construction of support system including rock bolting,</b>
	<b>(c) On complete completion of tunnel</b>

\* The above list is illustrative and may require modification as per the actual scope of the work

## **Annex 2. Onwards**

**IE / AE** should include comments, status update, data points and reports in following annexures which have not been included elsewhere in the main report. Such reports may include but not limited to:

- Review status of drawings/ design reports
- Review status of other documents
- Minutes of review meeting
- Detailed Inspection report of project highway
- Correspondence details
- Weather report
- Organizational chart of Contractor / Contractor and IE / AE
- List of lab equipment
- Details of user complaints
- Project photographs

**Annexure VI- Monthly Progress Report in O&M Phase**

**[NATIONAL HIGHWAYS & INFRASTRUCTURE  
DEVELOPMENT CORPORATION LTD.]**

**[PROJECT NAME]**

**Authority Engineer**

***[NAME OF CONSULTING FIRM]***

**MONTHLY STATUS REPORT NO. [XX]**

**FOR THE MONTH OF: [MONTH], [YEAR]**

## Table of content

Contents	Page Nos.
1 Executive Summary .....	156
1.1 Overall road condition	156
1.2 Key reporting metrics	156
1.3 Key maintenance activities undertaken	156
1.4 Pending issues	157
1.5 Recommended actions by Authority Engineer	157
1.6 Strip Plan for maintenance	158
2 Project Overview .....	159
2.1 Key project details	159
2.2 Location Map	160
2.3 Key plan	161
2.4 RoW availability	161
2.5 Summary of project features	162
3 Critical Issues and Action taken .....	163
3.1 Issue and action log	163
3.2 Summary of items (Cumulative Observations/ Deficiencies)	163
3.3 Obligations as per contract	165
3.4 Major maintenance and Inspection schedule	166
4 Inspection Report .....	167
4.1 Summary of NCR issued	167
4.2 Equipment based inspection report	167
5 Monitoring of ETC lanes .....	169
5.1 Monthly ETC Report	169
5.2 On-ground infrastructure report	169
5.3 On-ground ETC operations and SLA adherence	170
6 Status of Damages for breach of maintenance activities .....	170

6.1 Damages for non completion of project facilities	170
6.2 Damages for breach of maintenance activities	171
6.3 Damages for non completion of major maintenance/ periodic overlay	171
7 Change of Scope proposals.....	172
8 Status of pending disputes.....	172
9 Reports.....	173
9.1 Monthly Toll Collection Report (Applicable only if project highway is tolled)	173
9.2 Accident Report	174
9.3 Details of complaints	176
9.4 Encroachment list	177
9.5 Lane Closure Report	177
10 Annexures .....	178

## 1 Executive Summary 1.1 Overall road condition

Road condition	LHS	RHS
Satisfactory road condition	40 km	20 km
Poor road condition	50 km	70 km
<b>Total length of project</b>	<b>90 km</b>	<b>90 km</b>

## 1.2 Key reporting metrics

Key metrics	Value/Amount
No of pending NCRs	35
Damages amount recommended on Contractor (Rs Cr)	Rs 5.9 Cr
No of pending Change of Scope proposals	2
No of pending disputes	2
Monthly toll collection (Rs Cr) <i>(If applicable)</i>	Rs 3.8 Cr
No of accidents	12
No of encroachments	47

## 1.3 Key maintenance activities undertaken

Asset	Maintenance activities undertaken
Pavement	☐ Concessionaire has commenced the work for renewal and repair of pavement on the project highway w.e.f 14th September 2016
Shoulder	
Drainage	☐ Cleaning of drainage in built up areas n progress
Median	
Road furniture	☐ Concessionaire has taken up repairs and maintenance of MCB and electric poles, etc on issuance of NCPs from Authority Engineer
Bridges	
Buildings	☐ As per provisions of CA and policy decided by MoRTH/<Agency>, 2 ETC lanes at each toll plaza have been operationalised w.e.f. 25th September 2016. The connectivity of ETC lanes with Central Clearing House (CCH) has been achieved and presently ETC lanes are operationalized in Hybrid Mode due to less number of tags purchased by highway users
Horticulture	☐ Planting of new trees from Chainage 200+300 to 226+650 ☐ Trimming of plants which were causing obstruction to highway users

## 1.4 Pending issues

- Overlay on the entire stretch of project length of 252 km and service roads has not been taken up by Contractor yet since the date of completion of overlay is due in next 25 days
- Over all progress is very slow regarding repair of potholes and rutting on Main Carriageway which is causing inconvenience to highway users and is also a concern from road safety point of view.
- Street lighting in

- **Anantapur bypass** completed on main carriageway and is energized but for

service roads street lighting is pending on both sides

- **Kurnool bypass** erection of poles only completed in main carriageway not yet energized till to date, but for service roads not started

### **1.5 Recommended actions by Authority Engineer**

- In spite of the repeated requests, there is no material change in status of works pertaining to repairs/ rectifications of defects on the project highway. AE has recommended the damages of Rs 5.9 Cr on the Contractor on account of delay in repairs of defects in road and bridge works in terms of the provision of Clause 15.8.1 of the Concession Agreement. Contractor shall be liable for imposition of further damages on similar lines till the date of completion
- Contractor is requested to take at most care for completing the overlay before 31.03.2017 since the existing road condition is getting deteriorated day by day causing much inconvenience to the traffic

All figures and graphs in templates are illustrative. Please add actual details.

### 1.6 Strip Plan for maintenance

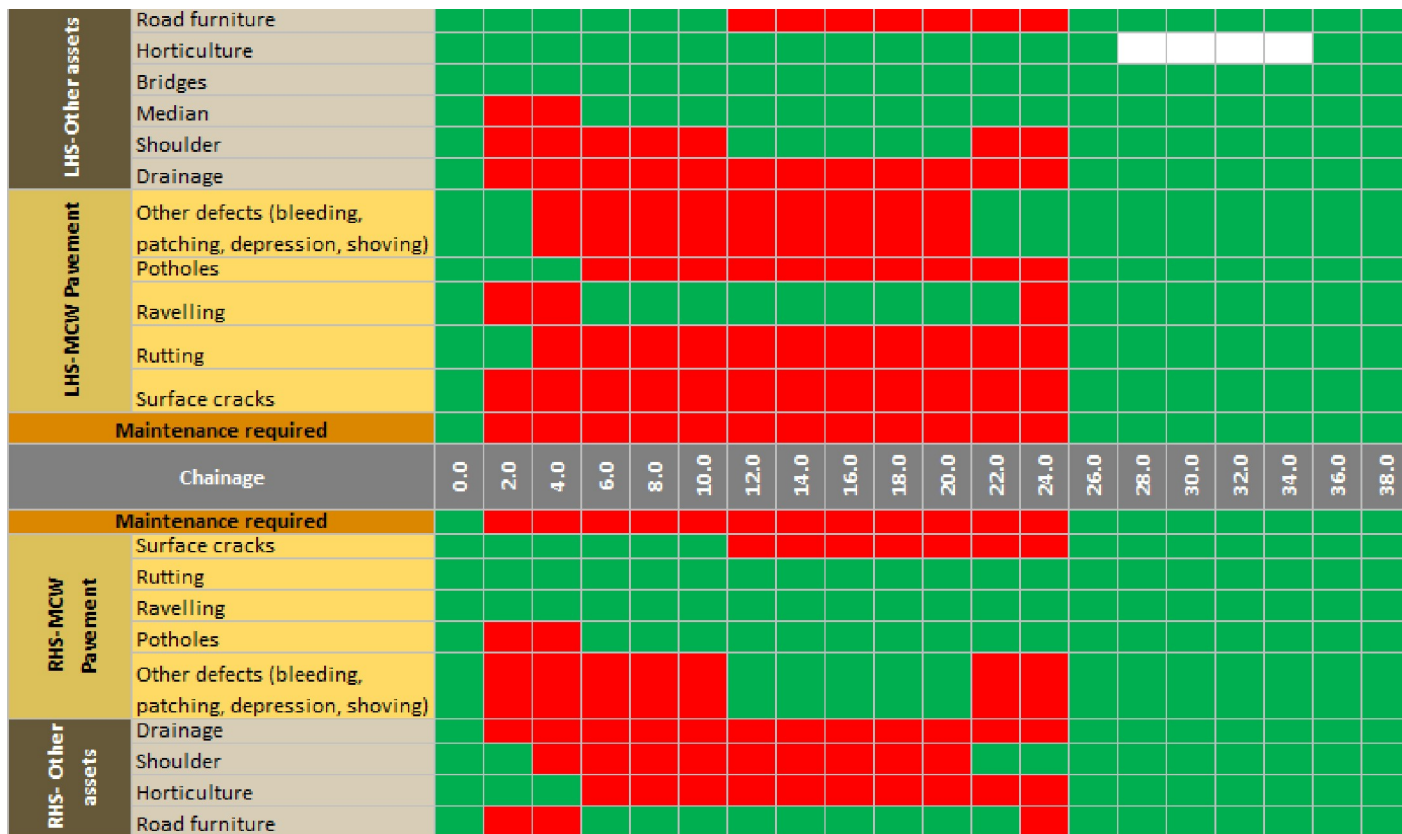

Satisfactory road condition (Maintenance not required)	Green
Poor road condition (Maintenance required)	Red

*All figures and graphs in templates are illustrative. Please add actual details.*

## Main report

### 1 Project Overview

#### 1.1 Key project details

<b>Project Name</b>	
<b>NH no (New/Old)</b>	
<b>Mode of the Project</b>	
<b>No. of Lanes</b>	
<b>Length of the Project</b>	
<b>Total Project Cost</b>	
<b>Contractor/ Contractor</b>	
<b>Date of Award (LOA date)</b>	
<b>Appointed Date</b>	
<b>Commercial Operation Date (COD)</b>	
<b>Concession Period</b>	
<b>O&amp;M Period</b>	
<b>Authority Engineer</b>	
<b>AE Agreement Date</b>	
<b>AE Mobilization Date</b>	
<b>AE Scheduled Completion Date</b>	
<b>AE EOT (Extension Of Time)</b>	

All figures and graphs in templates are illustrative. Please add actual details.

## 2.2 Location Map

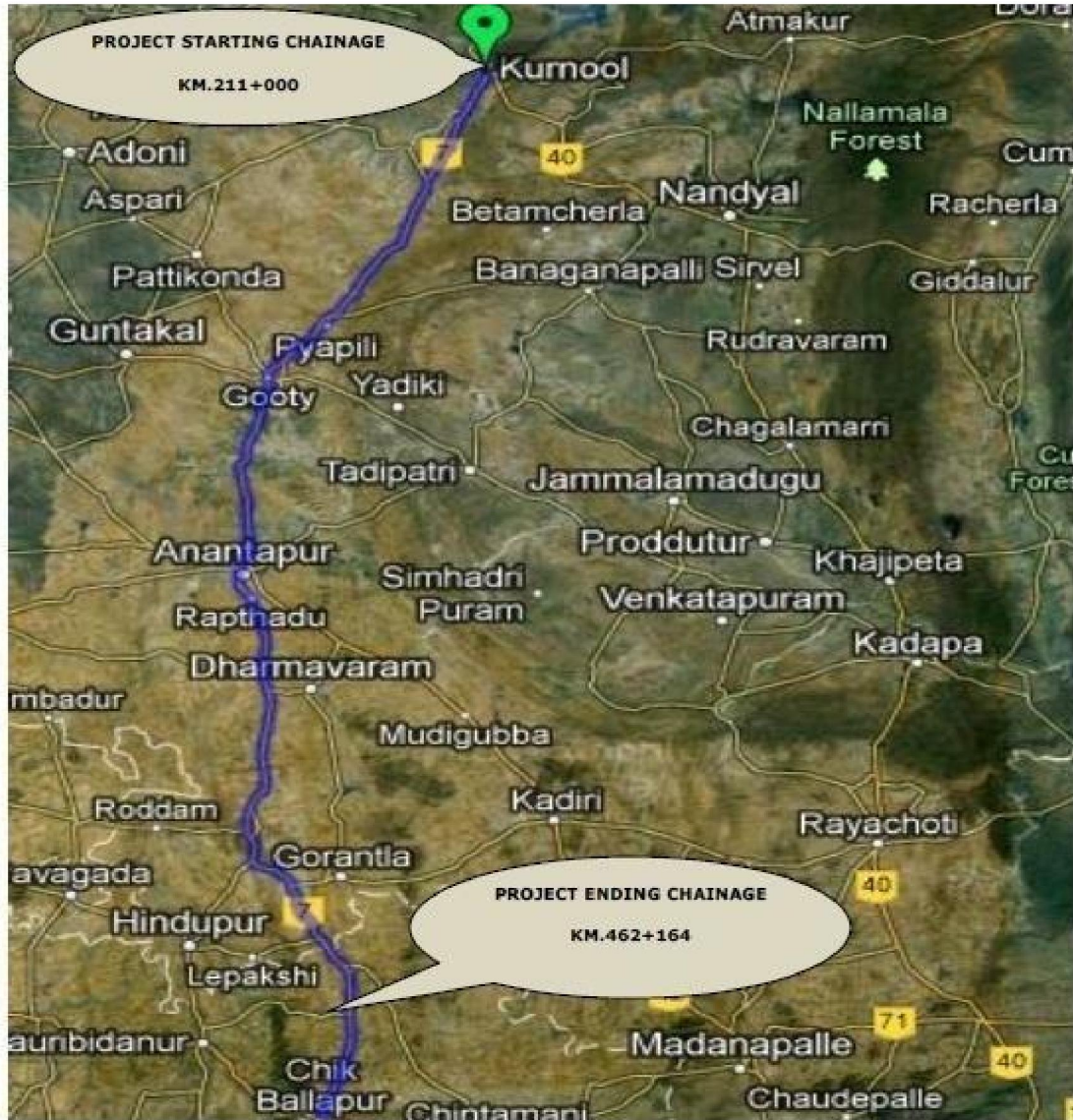



## 2.5 Summary of project features

SNo	Particulars	Value
1	No of flyovers	2
2	Service Road	45
3	ROBs	5
4	ROB location (chainage)	261.975, 299.606, 350.547, 396.135 & 420.302
5	RUBs	0
6	RUB location (chainage)	NA
7	No of Bypass	7
8	Length of Bypass	43
9	No of Major Bridges	7
10	No of Minor Bridges	67
11	No of Culvert	640
12	No of VUP	16
13	No of PUP/ Cattle Underpass	12
14	No of Major Intersection/ Junction	22
15	No of Toll Plaza	3
16	Location of Toll Plaza (chainage)	
17	No of Truck Laybye	30
18	No of Bus Bays	122
19	No of Wayside Amenities	0
20	Location of Wayside Amenities (chainage)	NA

*All figures and graphs in templates are illustrative. Please add actual details.*

### 3 Critical Issues and Action taken 3.1

#### Issue and action log

SNo	Issue Description	Ongoing/New Issue	Concerned Authority	Chainage(s) affected due to the issue	Length affected (km)	Action(s) taken till now	Action(s) suggested by SC	Expected Date for resolving issue
1	Drying up of plants on median	Ongoing	Concessionaire	325+200 to 327+800	2.6	Irregular watering	Replacement of plants and daily watering	NA
2	Large potholes	New	Concessionaire	387+300 LHS	0.1	None	Filling of potholes	<DD/MM M>

*All figures and graphs in templates are illustrative. Please add actual details.*

### 3.2 Summary of items (Cumulative Observations/ Deficiencies)

SNo	Description	Unit	Total	Work done upto previous month	Work done during reporting month	Balance	Remarks
<b>1</b>	<b>Carriageway and paved shoulders</b>						
	Pot Holes	Sqm	42	-	-	42	
	Roughness value exceeding	mm					
(c)	Cracking in more than 5% of road surface	Sqm	7179	-	-	7179	
(d)	Rutting exceeding 10mm in more than 2% of road surface	Sqm	5	-	-	5	
(e)	Bleeding/Skidding	Sqm					
(f)	Ravelling	Sqm					
(g)	Damage to pavement edges exceeding 10cm	m					
<b>2</b>	<b>Hard/Earth Shoulders</b>						
(a)	Rain cuts/ gullies in slope	Cum	650	25	-	625	

SNo	Description	Unit	Total	Work done upto previous month	Work done during reporting month	Balance	Remarks
(b)	Edge drop at shoulders exceeding 40 mm	m					
<b>3</b>	<b>Drains and culverts</b>						
(a)	Cleaning of Culvert	Nos	1	-	-	1	
(b)	Damage to or silting of culverts						
(c)	Silting of drains in urban/ semi urban areas						
<b>4</b>	<b>Road furniture</b>						
(a)	Sign Boards	Nos	456	-	-	456	
(b)	Kilometer Stones						
(c)	Metal Beam Crash Barrier						
	Bus Shelters	Nos	72	4	-	68	
	Junction signs	Nos	26	8	-	18	
	Median Grills	Rmt	894	-	-	894	
	Studs	Nos	5328	-	-	5328	
	Delinators	Nos	8236	-	-	8236	
	Road Marking	Sqm	1899	-	-	1899	
	Kerb Painting	Sqm	4575	-	-	4575	
	Guard Posts	Nos	3657	-	-	3657	
<b>5</b>	<b>Street lighting and telecom (ATMS)</b>						
	Street lights	Nos					
	Telecom	Nos					
<b>6</b>	<b>Trees and plantation</b>						
	Removal of vegetation affecting sight line and road structures	Ha	77.42	-	3.57	73.85	
	Replacement of trees and bushes	Nos	15072	-	-	15072	
<b>7</b>	<b>Buildings and bridges</b>						
	Rest areas						
	Toll plazas						
(c)	Bridges						

### 3.3 Obligations as per contract

*Please write a summary of contractual obligations of Contractor and non-compliances of critical obligations highlighting reasons for delay and stating pending actions*

- Critical obligations of Contractor as per contract
- Non compliances of critical contractual obligations

### 1.4 Major maintenance and Inspection schedule

Item	Responsibility	Last completed on	Due date
Major maintenance	Contractor	[DD/MM/YY]	[DD/MM/YY]
Periodic overlay	Contractor	[DD/MM/YY]	[DD/MM/YY]
Pavement inspection using NSV	Authority Engineer	[DD/MM/YY]	[DD/MM/YY]
Roughness using Laser Profilometer	Authority Engineer	[DD/MM/YY]	[DD/MM/YY]
Pavement strength using FWD	Authority Engineer	[DD/MM/YY]	[DD/MM/YY]
Bridge inspection using MBIU	Authority Engineer	[DD/MM/YY]	[DD/MM/YY]
Road sign inspection using Reflectometer	Authority Engineer	[DD/MM/YY]	[DD/MM/YY]
Other			

All figures and graphs in templates are illustrative. Please add actual details.

## 4 Inspection Report

### 4.1 Summary of NCR issued

SNo	Highway asset	Total NCR issued till previous month (A)	NCR issued in reporting month (B)	NCR closed in reporting month (C)	Balance NCR (A+B-C)
1	Pavement	48	12	25	35
2	Shoulder	7	0	3	4
3	Drainage				
4	Median				
5	Road furniture				
6	Bridges				
7	Buildings				
8	Horticulture				
9	[Other assets]				
	<b>Total</b>				

### 4.2 Equipment based inspection report

Starting Chainage	Ending Chainage	Lane number	Pavement Surface Defects							Roughness	Pavement Strength		
			Cracks (cm)	Potholes (cm)	Raveling (cm)	Bleeding (cm)	Rutting depth (mm)	Texture depth (mm)	Skid Resistance		IRI (International Roughness Index)	Elastic Modulus Bituminous E1	Elastic Modulus
0.000	0.500	L1	2X10	20X35	2.5X1.2	4X12	25	1.4		4.23	7110	34	14
0.500	1.000	L1	3X5	10X15	1.5X0.8	3X10	24	1.8		2.68	7430	36	15
1.000	1.500	L1											

Report of equipment based inspection needs be provided as an Annexure to monthly report as per the defined frequency. Following documents/media to be submitted for equipment based inspection.

- Video footage of all cameras installed on Network Survey Vehicle- ROW cameras and pavement camera
- Network Survey Vehicle report capturing dimensions of following key metrics of pavement

→ Crack

- Potholes
  - Raveling
  - Bleeding
  - Rutting
  - Texture depth
  - Skid resistance
  - Roughness (IRI)
- Falling Weight Deflectometer (FWD) report capturing following key metrics of pavement strength
    - Deflection Bowl (Transient Deflections at seven different points)
    - Corrected Elastic Modulus Bituminous E1
    - Corrected Elastic Modulus Granular E2
    - Corrected Elastic Modulus Subgrade E3
    - Subgrade CBR
    - Bituminous layer coefficient A1
    - Base layer coefficient A2
    - Granular base layer coefficient A3
    - Modified structural number
  - Mobile Bridge Inspection Report (MBIU) capturing following key metrics of bridges
    - Condition Approach
    - Condition Signs
    - Condition Debris
    - Condition Joint
    - Condition Deck
    - Condition Rails
    - Condition Protect
    - Condition Stream
    - Condition Superstructure
    - Condition Piers
    - Condition Abutment
  - Retro reflectometer report capturing following key metrics of road furniture
    - Coefficient of retroreflected luminance RA (night time retroreflection) of road traffic signs

All figures and graphs in templates are illustrative. Please add actual details.

## 5 Monitoring of ETC lanes 5.1

### Monthly ETC Report

TYPE OF VEHICLE			For Corresponding month of previous year		For Previous Month		For Current Month		
			No of vehicles	Fee Collected	No of vehicles	Fee Collected	Fee per vehicle	No of vehicles	Fee Collected
A	Car	Total	3845	384500	4659	465,900.00	100	4289	428,900.00
B	LCV	Total	1521	243360	1312	209,920.00	160	1399	223,840.00
C	Bus	Total	2404	793386	2284	765,207.00	201	2349	786,915.00
D	Truck	Total	1603	528924	1523	510,138.00	134	1566	524,610.00
E	3 Axle	Total	18990	6836400	16310	5,953,150.00	365	15127	5,521,355.00
F	MAV	Total	16119	8381880	21111	11,188,830.00	530	18790	9,958,700.00
G	Over Size	Total	1	630	27	17,280.00	640	36	23,040.00
Total for the Month			49844	18,050,618	52963	19,898,834		49016	18,265,661

### 5.2 On-ground infrastructure report Total

number of plaza lanes =

Total number of dedicated ETC lanes =

Total number of hybrid lanes =

SNo	Description	Total units	Units working	Units damaged/missing	Equipment owner/provider	Equipment as per specifications (Y/N)	Remarks
1	<b>Hardware</b>						
(a)	Over-head transceiver	4	3	1	ABC Co.	Y	
(b)	Hand-held reader						
(c)	Lane controller						
	AVC						
	Camera						
	Weigh-in-motion						
	Static weigh bridge						
	Any other items						
2	<b>Softwares</b>						

SNo	Description	Total units	Units working	Units damaged/missing	Equipment owner/provider	Equipment as per specifications (Y/N)	Remarks
	Software — Lane/ Plaza level						
	TMS						
	Any other items						

### 5.3 On-ground ETC operations and SLA adherence

Lane	Average queue length during peak time	Average queue length during non peak time	Average Transaction time (cash)	Average transaction time (RFID)	Average transaction time (cards)	Average transaction time (wallet)	Average transaction time (others)
Lane 1	10 vehicles	5 vehicles	15 seconds	10 seconds	20 seconds	25 seconds	UPI - 20 seconds
Lane 2							
Lane 3							

- Average system uptime = 80%
- Transactions uploaded (as per SLA) = 80%
- Blacklists uploaded (as per SLA) = 50%
- Blacklists downloaded (as per SLA) = 85%

## 6 Status of Damages for breach of maintenance activities 6.1

### Damages for non completion of project facilities

SNo	Period	Amount of damages (Rs)
1	Upto June 2016	15,00,35,000
2	Jul 2016	2,00,88,000
3	Aug 2016	2,00,88,000
4	Sep 2016	1,94,40,000
	<b>Total</b>	<b>20,96,51,000</b>

### Supporting Calculations for damages for Sep 2016

- No of days in Sep = 30
- Performance security is Rs 64,80,00,000
- As per CA Clause 12.3.2 damages payable is 0.1% of performance security per day = Rs 6,48,000
- Total damages payable = 30 X 6,48,000 = Rs 1,94,40,000

### 6.2 Damages for breach of maintenance activities

SNo	Period	Amount of damages (Rs)
1	Upto June 2016	1,00,35,000

2	Jul 2016	6,63,196
3	Aug 2016	6,63,196
4	Sep 2016	52,22,444
	<b>Total</b>	<b>1,65,83,836</b>

**Supporting Calculations for damages for reporting month**

**6.3 Damages for non completion of major maintenance/ periodic overlay**

S No	Nature of defect	Unit	Total Quantity	Rate	Cost o repair as estimated	Damages as per CA	Damages at higher side	Date of inspection	No of days as per CA	Damages from	No of days damages	Damages amount

SNo	Period	Amount of damages (Rs)
1	June 2016	6,48,000
2	Jul 2016	2,00,88,000
3	Aug 2016	2,00,88,000
4	Sep 2016	1,94,40,000
	<b>Total</b>	<b>6,02,64,000</b>

**Supporting Calculations for damages for Sep 2016**

- No of days in Sep = 30
- Performance security is Rs 64,80,00,000
- As per CA Clause 12.3.2 damages payable is 0.1% of performance security per day = Rs 6,48,000
- Total damages payable = 30 X 6,48,000 = Rs 1,94,40,000

*All figures and graphs in templates are illustrative. Please add actual details.*

### 7 Change of Scope proposals

SN o	Proposal Details	Date of first submission to AE	Current status	COS Amount	Expected/ Actual date of approval
1	Construction of [Flyover Name] at [Chainage]	[DD/MM/YYYY]	Approved in principle by Authority. Detailed quantities in proper order yet to be submitted	[+/-Amount]	[DD/MM/YYYY]
2	Nallah diversion through box culvert at [Chainage]	[DD/MM/YYYY]	Clarifications to be submitted by Contractor, expected date [DD/MM/YYYY]	[+/- Amount]	[DD/MM/YYYY]

### 8 Status of pending disputes

SoN	Dispute Details	Date of first submission to AE	Suggested resolution by AE	Dispute Amount (if applicable)	Current stage
1	Increased tollable length to be applicable in toll fee calculations	[DD/MM/YYYY]	No merit in increasing tollable length hence no action required by NHIDCL	NA	SAROD
2	Filling stations energized without obtaining NOC from ministry	[DD/MM/YYYY]	NHIDCL to consider the Contractor's request for intervention and assistance	[+/- Amount]	B/w Concessionaire and NHIDCL

*All figures and graphs in templates are illustrative. Please add actual details.*

## 9 Reports

### 9.1 Monthly Toll Collection Report (Applicable only if project highway is tolled)

TYPE OF VEHICLE			For Corresponding month of previous year		For Previous Month		For Current Month		
			No of vehicles	Fee Collected	No of vehicles	Fee Collected	Fee per vehicle	No of vehicles	Fee Collected
A	Car	Single	3845	384500	4659	465,900.00	100	4289	428,900.00
		Return	1506	218370	1972	295,800.00	150	1758	263,700.00
		Local	769	38450	979	48,950.00	50	1029	51,450.00
B	LCV	Single	1521	243360	1312	209,920.00	160	1399	223,840.00
		Return	134	31490	162	38,880.00	240	132	31,680.00
		Local	1683	134640	1838	147,040.00	80	1461	116,880.00
C	Bus	Single	2404	793386	2284	765,207.00	201	2349	786,915.00
		Return	359	177903	173	87,567.00	303	203	102,717.00
		Local	277	45738	205	34,782.00	102	318	54,060.00
D	Truck	Single	1603	528924	1523	510,138.00	134	1566	524,610.00
		Return	240	118602	116	58,378.00	202	136	68,478.00
		Local	185	30492	136	23,188.00	68	212	36,040.00
E	3 Axle	Single	18990	6836400	16310	5,953,150.00	365	15127	5,521,355.00
		Return	131	70740	34	18,700.00	550	37	20,350.00
		Local	69	12420	84	15,540.00	185	131	24,235.00
F	MAV	Single	16119	8381880	21111	11,188,830.00	530	18790	9,958,700.00
		Return	2	1550	20	15,800.00	790	35	27,650.00
		Local	6	1560	18	4,770.00	265	8	2,120.00
G	Over Size	Single	1	630	27	17,280.00	640	36	23,040.00
		Return		0	0	-	965		-
		Local		0	0	-	320		-
<b>Total for the Month</b>			<b>49844</b>	<b>18,050,618</b>	<b>52963</b>	<b>19,898,834</b>		<b>49016</b>	<b>18,265,661</b>

## 9.2 Accident Report

		S No	
		Date	
		Chainage no	
		Time of accident	
		Sex (M/F)	
		A	Accident location
		B	Nature of accident
		C	Classification of accident
		D	Causes
		E	Load conditions of vehicle
		1	
		4	
		3	
		2	
		2	
		382/050	
		RHS	
		1/1/17	
		05:25	
		pm	

*All figures and graphs in templates are illustrative. Please add actual details.*

		1	Road condition	F
			Intersection type of control	G
		1	Weather condition	H
		3	Age of victim	I
		1	Type of victim	J
		3	Type of vehicle	K
			Fatal	No of affected persons
		1	Major	
		1	Minor	
		Ambu	Help provided by	

## Mapping of report fields to responses

A	1. Urban 2. Rural
B	1. Overturned 2. Head On Collision 3. Hit from Back 4. Hit to Fix Object 5. Right turn Collision 6. Left turn Collision 7. Veered Out off The Road 8. Hit Pedestrian 9. Unknown/Hit & Ran Away
C	1. Fatal 2. Major injury 3. Minor injury
D	1. Drunken 2. Over Speeding 3. Vehicle out of Control 4. Driven on wrong side 5. Mechanical Problem 6. Drowsiness/Not Applicable 7. Fault of Driver
E	1. Normally Loaded 2. Overloaded/Handing 3. Empty 4. Unknown
F	1. Straight road 2. Slight Curve 3. Sharp Curve 4. Hump 5. Dip
G	1. T-Junction 2. Y-Junction 3. Four arm Junction 4. Staggered Junction 5. Junction with more than 6. Round about Junction
H	1. Fine/Clear 2. Mist/Fog 3. Cloudy 4. Light Rain 5. Heavy Rain 6. Strong Wind 7. Dust Storm 8. Cold 9. Hot
I	1. 0-18 Years 2. 18-25 Years 3. 25-40 Years 4. 40-60 Years 5. 60-80 Years
J	1. Driver 2. Passenger 3. Pedestrian 4. Cyclist 5. Others
K	1. Two Wheeler 2. Auto Rickshaw 3. Car/Jeep 4. Bus 5. Light Truck 6. Heavy Truck 7. Tractor 8. Bicycle 9. Cycle Rickshaw 10. Hand Drawn Cart 11. Animal Drawn Cart

*All figures and graphs in templates are illustrative. Please add actual details.*

### 9.3 Details of complaints

SNo	Toll plaza	Complaint No	Date	Name of the person	Contact details of person	Details of complaint	Compliance by the Contractor
1		81	8/9 /2016	Mr. Shailendra Gurjar, LIG-44, RSS mohalla, Shivaji Nagar, Bhopal (M.P.)		Mr. Shailendra Complaints regarding Pot holes on the Highway may cause accidents.	Pot holes are repaired
2		82	10/9/2016	Dr. Anil Diwakar, HIG Swarganga Complex Bus Stand Seoni (M.P.)		Dr. Diwakar complaints that presence of Animals and also Pot holes on road are obstructing the driving which may cause accidents.	Animals are continuously drivenout from the Road by the Highway Patrolling team Pot holes are repaired.
3		83	11/9/2016	Maj. Sidharth, 238 Fd wksp C/o-56 APO		Maj. Sidharth while travelling in personal car wants Exemption from Toll Fee on production of I.D. Card	The Exemption under Indian Toll (Army and Air force) Act 1901, to army personnel travelling in private vehicle may be given if on Govt. duty with requisite pass as specified in the Indian Toll (Army and Air Force Rules, 1942)

All figures and graphs in templates are illustrative. Please add actual details.

#### 9.4 Encroachment list

SNo	Stretch Chainage (km)	Side (LHS/RHS)	District/ Tehsil	Village	Encroachment type (Temporary/ Permanent)	Category (Tea stall, Temple, etc)	Establishment (New/ existing)	Distance from road edge (m)	Encroachment width and length	Name of Encroacher
1	212+50 0	LHS	Kurnool	Kurnool	Temporary	Tea stall	New	7	5mX3.5m	Vijay Kumar Reddy
2	213+20 0	RHS	Kurnool	Dinnedevara Padu	Permanent	Godown	Existing	5	10.5m X 4m	Buddana

#### 9.5 Lane Closure Report

S.No	Date	Chainage (Km)		Side	Time of Closure	Reasons for Lane Closure & Approval Details	Remarks
		From	To				
1	9/9/2016	2150+30	2150+35	RHS	1 pm-4pm	Patch work	

## 10 Annexures

### Annexure 1: Detailed visual inspection report of project highway

**Assets to be covered-** Pavement, Shoulder, Drainage, Median, Bridges, Road furniture, Buildings, Horticulture, Service Road

SNo	NCP/ SNo	Date of issue	Description of defect	Chainage	Side	AE Remarks
1	311	15.08.2016	Potholes	311+200	LHS	To be repaired
2	312	15.08.2016	Cracking	311+500	RHS	To be filled immediately
3						
4						

### Annexure 2 onwards:

AE should include comments, status update, data points and reports in following annexures which have not been included elsewhere in the main report. Such reports may include but not limited to:

- Minutes of review meeting
- Correspondence details
- Weather report
- Organizational chart of Contractor and AE
- Project photographs

**Annexure VII-OUTPUT FORMAT FROM NETWORK SURVEY VEHICLE AND FWD TESTING**

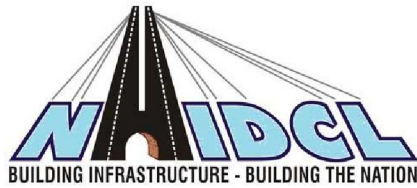

**[NATIONAL HIGHWAYS & INFRASTRUCTURE DEVELOPMENT CORPORATION LTD.]**

**[Name of the Work]**

**Authority Engineer**  
*[NAME OF CONSULTING FIRM]*

**OUTPUT FROM NETWORK SURVEY VEHICLE AND FWD TESTING**

## Table of contents

Contents	Page Nos.
<b>SECTION 1 ROAD INVENTORY DATA</b>	<b>161</b>
1.1. Location Reference Post (LRP) Master	161
1.2. Carriageway Type	162
1.3. Road Type	162
1.4. Pavement Type	163
1.5. Pavement Width	164
1.6. Shoulder Type	165
1.7. Shoulder Width	166
1.8. Topography	166
1.9. Cross Section	167
1.10. Drain Type	168
1.11. Median Opening	169
1.12. Right Of Way	170
1.13. Pavement composition	171
1.14. Carriageway Furniture	173
1.15. Wayside Amenities	174
1.16. Land Use	175
<b>SECTION 2 ROAD CONDITION DATA</b>	<b>176</b>
2.1. Visual condition	176
2.2. Roughness	179
2.3. Rutting	180
2.4. Texture Depth	181
2.5. Skid Resistance	182
2.6. Falling Weight Deflectometer (FWD)	183
2.7. Falling Weight Deflectometer (FWD) Rigid	187

**Annexure VII: OUTPUT FORMAT FROM NETWORK SURVEY VEHICLE AND FWD TESTING (SECTION 1: TESTING AT TIME OF COMPLETION, SECTION 2: FWD ATTRIBUTES - ANNUALLY, BALANCE PARAMETERS BIANNUALLY AFTER CONSTRUCTION PHASE)**

In addition to the reports being submitted on equipment based inspection as specified in Section 4.2 of the Monthly Progress Report in the O&M phase, the Authority Engineer (AE) shall submit electronically in excel (.xls) format certain key parameters to the Project Director in the following format.

Worksheets under Section 1 ('Road inventory data') shall be updated from surveys conducted only once at the time of completion testing. Worksheets under Section 2 ('Road condition data') shall be updated from surveys carried out annually for FWD attributes and biannually for the remaining attributes.

The fields to be updated in each of the worksheets are described below. Each description is followed by an example of data for a sample project.

**SECTION 1 - ROAD INVENTORY DATA**

Road inventory data consists of parameters which provide basic information about roads such as pavement type, number of lanes, topography, etc. These parameters are largely static in nature, and therefore a survey to update this dataset shall be conducted only once at the time of completion testing. The road inventory data shall be used to update specific worksheets listed below.

**1.1 Location Reference Post (LRP) Master**

The following table lists the fields which need to be populated for the 'LRP Master' attribute. The descriptions of the fields are given below.

Field	Description	Example
NH Number	New National Highway number	NH0065
LRP Name	Name of location reference post (LRP)	Km stone 17
Chainage	Chainage of the survey point (in km)	17
Direction	Direction of survey <input type="checkbox"/> Increasing (chainage) <input type="checkbox"/> Decreasing (chainage)	Increasing
Latitude	Latitude of survey point	9.98897
Longitude	Longitude of survey point	78.02671
Survey Date	Date of survey in the format <DD-MM-YY>	06-05-17
Old NH Number	Old National Highway number	NH0065
Section Code	Code indicating starting and ending locations of section	HYD-VIJ (Hyderabad-

A sample output is shown below for reference

NH Number	LRP Name	Chainage	Direction	Latitude	Longitude	Altitude	Survey Date	Old NH Number	Section Code
NH0xxx	Road Start	1.230	Increasing	9.98897	78.0267	63.0776	23-12-	NH0yyy	ABC-DEF
NH0xxx	Km Stone 8	8.000	Increasing	9.98444	78.0293	68.6012	23-12-	NH0yyy	ABC-DEF
NH0xxx	Km Stone 8	8.030	Increasing	9.98341	78.0300	68.1552	23-12-	NH0yyy	ABC-DEF
NH0xxx	Km Stone	9.008	Increasing	9.98107	78.0307	65.1715	23-12-	NH0yyy	ABC-DEF
NH0xxx	Km Stone	12.012	Increasing	9.96328	78.0416	56.0343	23-12-	NH0yyy	ABC-DEF
NH0xxx	Km Stone 17	17.085	Increasing	9.95385	78.0525 5	56.2474 8	23-12- 15	NH0yyy	ABC-DEF

## 1.2 Carriageway Type

The following table lists the fields which need to be populated for the 'Carriageway Type' attribute. The descriptions of the fields are given below.

Field	Description	Example
NH Number	New National Highway number	NH0065
Section Code	Code indicating starting and ending locations of section	HYD-VIJ (Hyderabad-Vijayawada)
Start Chainage	Chainage of the start point (in km)	0.500
End Chainage	Chainage of the end point (in km)	1.500
Carriageway Type	Type of carriageway, classified into one of the below categories: <input type="checkbox"/> Divided <input type="checkbox"/> Undivided	Divided
Survey Date	Date of survey in the format <DD-MM-YY>	06-05-17
Latitude	Latitude of survey point	9.98897
Longitude	Longitude of survey point	78.02671

A sample output is shown below for reference

NHNumber	Section	Start Chainage	End Chainage	Carriageway Type	Date of Survey	Latitude	Longitude
NH00xx	ABC-DEF	0.000	0.794	Undivided	06-05-17	9.98897	78.02671
NH00xx	ABC-DEF	0.794	1.000	Undivided	06-05-17	9.98444	78.02934
NH00xx	ABC-DEF	1.000	2.810	Undivided	06-05-17	9.98341	78.03004
NH00xx	ABC-DEF	2.810	4.335	Undivided	06-05-17	9.98107	78.03078
NH00xx	ABC-DEF	4.335	6.666	Undivided	06-05-17	9.96328	78.04160
NH00xx	ABC-DEF	6.666	12.906	Undivided	06-05-17	9.95385	78.05255

### 1.3 Road Type

The following table lists the fields which need to be populated for the 'Road Type' attribute. The descriptions of the fields are given below.

Field	Description	Example
NH Number	New National Highway number	NH0065
Section Code	Code indicating starting and ending locations of section	HYD-VIJ (Hyderabad-Vijayawada)
Start Chainage	Chainage of the start point (in km)	0.500
End Chainage	Chainage of the end point (in km)	1.500
Road Type	Classification of road on basis of number of lanes <input type="checkbox"/> Single Lane <input type="checkbox"/> Two Lane <input type="checkbox"/> Intermediate Lane <input type="checkbox"/> Four Lane <input type="checkbox"/> Six Lane	Four Lane
Survey Date	Date of survey in the format <DD-MM-YY>	06-05-17
Latitude	Latitude of survey point	9.98897
Longitude	Longitude of survey point	78.02671

A sample output is shown below for reference:

NHNumber	Section	Start Chainage	End Chainage	RoadType	Date of Survey	Latitude	Longitude
NH00xx	ABC-DEF	0.000	0.794	Two Lane	06-05-17	9.98897	78.02671
NH00xx	ABC-DEF	0.794	1.000	Two Lane	06-05-17	9.98444	78.02934
NH00xx	ABC-DEF	1.000	2.810	Two Lane	06-05-17	9.98341	78.03004
NH00xx	ABC-DEF	2.810	4.335	Two Lane	06-05-17	9.98107	78.03078
NH00xx	ABC-DEF	4.335	6.666	Two Lane	06-05-17	9.96328	78.04160
NH00xx	ABC-DEF	6.666	12.906	Two Lane	06-05-17	9.95385	78.05255

### 1.4 Pavement Type

The following table lists the fields which need to be populated for the 'Pavement Type' attribute. The descriptions of the fields are given below.

Field	Description	Example
NH Number	New National Highway number	NH0065
Section Code	Code indicating starting and ending locations of section	HYD-VIJ (Hyderabad-Vijayawada)
Start Chainage	Chainage of the start point (in km)	0.500
End Chainage	Chainage of the end point (in km)	1.500
Direction	Direction of survey <input type="checkbox"/> Increasing (chainage) <input type="checkbox"/> Decreasing (chainage)	Increasing
Pavement Type	Classification of pavement based on type of surface:	Asphalt

Field	Description	Example
	<input type="checkbox"/> Asphalt <input type="checkbox"/> Cement concrete	
Survey Date	Date of survey in the format <DD-MM-YY>	06-05-17
Latitude	Latitude of survey point	9.98897
Longitude	Longitude of survey point	78.02671

A sample output is shown below for reference:

NHNumber	Section	Start Chainage	End Chainage	Direction	Pavement Type	Date of Survey	Latitude	Longitude
NH00xx	ABC-DEF	0.000	0.804	Both	Asphalt	06-05-17	9.98897	78.02671
NH00xx	ABC-DEF	0.804	1.000	Both	Asphalt	06-05-17	9.98444	78.02934
NH00xx	ABC-DEF	1.000	1.172	Both	Asphalt	06-05-17	9.98341	78.03004
NH00xx	ABC-DEF	1.172	2.821	Both	Asphalt	06-05-17	9.98107	78.03078
NH00xx	ABC-DEF	2.821	4.350	Both	Asphalt	06-05-17	9.96328	78.04160
NH00xx	ABC-DEF	4.350	6.710	Both	Asphalt	06-05-17	9.95385	78.05255
NH00xx	ABC-DEF	6.710	12.925	Both	Asphalt	06-05-17	9.93102	78.05648

### 1.5 Pavement Width

The following table lists the fields which need to be populated for the 'Pavement Width' attribute. The descriptions of the fields are given below.

Field	Description	Example
NH Number	New National Highway number	NH0065
Section Code	Code indicating starting and ending locations of section	HYD-VIJ (Hyderabad-Vijayawada)
Start Chainage	Chainage of the start point (in km)	0.500
End Chainage	Chainage of the end point (in km)	1.500
Direction	Direction of survey <input type="checkbox"/> Increasing (chainage) <input type="checkbox"/> Decreasing (chainage)	Increasing
Pavement Width	Width of the pavement in metres, classified into one of the below categories >= 3.75m and < 5.5m >5.5m and < 7m >= 7m and < 10.5m >=10.5m and <=12.5m	>7m and <10.5m
Pavement Width Value	Width of the pavement in metres, rounded to two places after decimal	7.0

Field	Description	Example
Survey Date	Date of survey in the format <DD-MM-YY>	06-05-17
Latitude	Latitude of survey point	9.98897
Longitude	Longitude of survey point	78.02671

A sample output is shown below for reference:

NHNumber	Section Code	Start Chainage	End Chainage	Direction	Pavement	Pavement	Survey Date	Latitude	Longitude
					Width	Width Value			
NH00xx	ABC-DEF	0.000	0.794	Both	7 - 10.5 m	7.00	06-05-17	9.98897	78.02671
NH00xx	ABC-DEF	0.794	1.000	Both	7 - 10.5 m	7.00	06-05-17	9.98444	78.02934
NH00xx	ABC-DEF	1.000	2.810	Both	7 - 10.5 m	7.00	06-05-17	9.98341	78.03004
NH00xx	ABC-DEF	2.810	4.335	Both	7 - 10.5 m	7.00	06-05-17	9.98107	78.03078
NH00xx	ABC-DEF	4.335	6.666	Both	7 - 10.5 m	7.00	06-05-17	9.96328	78.04160
NH00xx	ABC-DEF	6.666	12.906	Both	7 - 10.5 m	7.00	06-05-17	9.95385	78.05255

## 1.6 Shoulder Type

The following table lists the fields which need to be populated for the 'Shoulder Type' attribute. The descriptions of the fields are given below.

Field	Description	Example
NH Number	New National Highway number	NH0065
Section Code	Code indicating starting and ending locations of section	HYD-VIJ (Hyderabad-Vijayawada)
Start Chainage	Chainage of the start point (in km)	0.500
End Chainage	Chainage of the end point (in km)	1.500
Direction	Direction of survey Increasing (chainage) Decreasing (chainage)	Increasing
Shoulder Type	Type of shoulder, classified into one of the below categories: None Paved Gravel Earth	Gravel
Survey Date	Date of survey in the format <DD-MM-YY>	06-05-17
Latitude	Latitude of survey point	9.98897
Longitude	Longitude of survey point	78.02671

A sample output is shown below for reference:

NHNumber	SectionCode	StartChainage	End Chainage	Direction	ShoulderType	SurveyDate	Latitude	Longitude
NH00xx	ABC-DEF	0.000	0.763	Increasing	No Shoulder	09-01-16	9.98897	78.02671
NH00xx	ABC-DEF	0.763	0.834	Increasing	Gravel	09-01-16	9.98444	78.02934

NH00xx	ABC-DEF	0.834	1.254	Increasing	Gravel	09-01-16	9.98341	78.03004
NH00xx	ABC-DEF	1.254	2.945	Increasing	Gravel	05-01-16	9.98107	78.03078
NH00xx	ABC-DEF	2.945	4.327	Increasing	Gravel	05-01-16	9.96328	78.04160
NH00xx	ABC-DEF	4.327	4.405	Increasing	Gravel	05-01-16	9.95385	78.05255
NH00xx	ABC-DEF	4.405	6.844	Increasing	Gravel	05-01-16	9.93102	78.05648
NH00xx	ABC-DEF	6.844	9.359	Increasing	Gravel	05-01-16	9.91229	78.04961
NH00xx	ABC-DEF	9.359	12.966	Increasing	Gravel	05-01-16	9.89041	78.03458

## 1.7 Shoulder Width

The following table lists the fields for the 'Shoulder Width' attribute, which need to be populated. The descriptions of the fields are given below.

Field	Description	Example
NH Number	New National Highway number	NH0065
Section Code	Code indicating starting and ending locations of section	HYD-VIJ (Hyderabad-Vijayawada)
Start Chainage	Chainage of the start point (in km)	0.500
End Chainage	Chainage of the end point (in km)	1.500
Direction	Direction of survey Increasing (chainage) Decreasing (chainage)	Increasing
Shoulder Width	Width of the shoulder in metres, classified into one of the below categories  No shoulder < 1m >= 1m and <= 2m	< 1m
Shoulder Width	Width of the shoulder in metres, rounded to one place after decimal	0.5
Survey Date	Date of survey in the format <DD-MM-YY>	06-05-17
Latitude	Latitude of survey point	9.98897
Longitude	Longitude of survey point	78.02671

A sample output is shown below for reference:

NH Number	Section Code	Start Chainage	End Chainage	Direction	Shoulder Width	Shoulder Width	Survey Date	Latitude	Longitude
NH0xxx	ABC-DEF	0.000	0.785	Increasing	No Shoulder	0.0	03-01-16	9.98897	78.02671
NH0xxx	ABC-DEF	0.785	2.612	Increasing	No Shoulder	0.0	03-01-16	9.98444	78.02934
NH0xxx	ABC-	2.612	3.170	Increasing	1-2m	2.0	03-01-16	9.98341	78.03004
NH0xxx	ABC-	3.170	5.194	Increasing	1-2m	2.0	03-01-16	9.98107	78.03078
NH0xxx	ABC-	5.194	6.793	Increasing	1-2m	2.0	03-01-16	9.96328	78.04160
NH0xxx	ABC-	6.793	11.404	Increasing	1-2m	2.0	03-01-16	9.95385	78.05255

## 1.8 Topography

The following table lists the fields which need to be populated for the 'Topography' attribute. The descriptions of the fields are given below.

Field	Description	Example
NH Number	New National Highway number	NH0065
Section Code	Code indicating starting and ending locations of section	HYD-VIJ (Hyderabad-Vijayawada)
Start Chainage	Chainage of the start point (in km)	0.500
End Chainage	Chainage of the end point (in km)	1.500
Topography	Topography of the road, classified into one of the below categories <input type="checkbox"/> Flat <input type="checkbox"/> Rolling <input type="checkbox"/> Hilly	Flat
Survey Date	Date of survey in the format <DD-MM-YY>	06-05-17
Latitude	Latitude of survey point	9.98897
Longitude	Longitude of survey point	78.02671

A sample output is shown below for reference:

NH Number	Section Code	Start Chainage	End Chainage	Topography	Survey Date	Latitude	Longitude
NH0xxx	ABC-DEF	0.000	0.808	Flat	05-01-16	9.98897	78.02671
NH0xxx	ABC-DEF	0.808	1.254	Flat	05-01-16	9.98444	78.02934
NH0xxx	ABC-DEF	1.254	2.828	Flat	05-01-16	9.98341	78.03004
NH0xxx	ABC-DEF	2.828	4.363	Flat	05-01-16	9.98107	78.03078
NH0xxx	ABC-DEF	4.363	6.724	Flat	05-01-16	9.96328	78.04160
NH0xxx	ABC-DEF	6.724	12.933	Flat	05-01-16	9.95385	78.05255

## 1.9 Cross Section

The following table lists the fields which need to be populated for the 'Cross Section' attribute. The descriptions of the fields are given below.

Field	Description	Example
NH Number	New National Highway number	NH0065
Section Code	Code indicating starting and ending locations of section	HYD-VIJ (Hyderabad-Vijayawada)
Start Chainage	Chainage of the start point (in km)	0.500
End Chainage	Chainage of the end point (in km)	1.500
Direction	Direction of survey Increasing (chainage) Decreasing (chainage)	Increasing
Cross Section	Cross section type, classified into one of the below categories	Fill

Field	Description	Example
	Cut Fill Cut and Fill Level	
Survey Date	Date of survey in the format <DD-MM-YY>	06-05-17
Latitude	Latitude of survey point	9.98897
Longitude	Longitude of survey point	78.02671

A sample output is shown below for reference:

NH Number	Section Code	Start Chainage	End Chainage	Direction	Cross Section	Survey Date	Latitude	Longitude
NH0xxx	ABC-DEF	0.000	0.822	Increasing	Level	03-01-16	9.98897	78.02671
NH0xxx	ABC-DEF	0.822	2.642	Increasing	Level	03-01-16	9.98444	78.02934
NH0xxx	ABC-DEF	2.642	3.199	Increasing	Level	03-01-16	9.98341	78.03004
NH0xxx	ABC-DEF	3.199	5.360	Increasing	Level	03-01-16	9.98107	78.03078
NH0xxx	ABC-DEF	5.360	5.715	Increasing	Fill	03-01-16	9.96328	78.04160
NH0xxx	ABC-DEF	5.715	6.941	Increasing	Level	03-01-16	9.95385	78.05255
NH0xxx	ABC-DEF	6.941	11.163	Increasing	Level	03-01-16	9.93102	78.05648

### 1.10 Drain Type

The following table lists the fields which need to be populated for the 'Drain Type' attribute. The descriptions of the fields are given below.

Field	Description	Example
NH Number	New National Highway number	NH0065
Section Code	Code indicating starting and ending locations of section	HYD-VIJ (Hyderabad-Vijayawada)
Start Chainage	Chainage of the start point (in km)	0.500
End Chainage	Chainage of the end point (in km)	1.500
Direction	Direction of survey Increasing (chainage) Decreasing (chainage)	Increasing
Drain Type	Type of drain, classified into one of the below categories Open unlined drain Open lined drain Covered line drain No drain	Open lined drain
Survey Date	Date of survey in the format <DD-MM-YY>	06-05-17
Latitude	Latitude of survey point	9.98897
Longitude	Longitude of survey point	78.02671

A sample output is shown below for reference:

NHNumber	SectionCode	StartChainage	EndChainage	Direction	DrainType	SurveyDate	Latitude	Longitude
NH0xxx	ABC-DEF	0.000	0.069	Increasing	Open Unlined Drain	09-01-16	9.98897	78.02671
NH0xxx	ABC-DEF	0.069	0.782	Increasing	Open Lined Drain	09-01-16	9.98444	78.02934
NH0xxx	ABC-DEF	0.288	0.000	Decreasing	Open Unlined Drain	09-01-16	9.98341	78.03004
NH0xxx	ABC-DEF	0.782	0.846	Increasing	Open Unlined Drain	09-01-16	9.98107	78.03078
NH0xxx	ABC-DEF	0.846	1.254	Increasing	Open Unlined Drain	09-01-16	9.96328	78.04160
NH0xxx	ABC-DEF	1.254	2.265	Increasing	Open Unlined Drain	05-01-16	9.95385	78.05255
NH0xxx	ABC-DEF	1.929	0.288	Decreasing	Open Unlined Drain	09-01-16	9.93102	78.05648
NH0xxx	ABC-DEF	1.952	1.929	Decreasing	No Drain	09-01-16	9.91229	78.04961
NH0xxx	ABC-DEF	2.265	3.005	Increasing	Open Unlined Drain	05-01-16	9.89041	78.03458
NH0xxx	ABC-DEF	2.680	1.952	Decreasing	Open Unlined Drain	09-01-16	9.88489	78.02995
NH0xxx	ABC-DEF	3.005	4.424	Increasing	Open Unlined Drain	05-01-16	9.87474	78.02828
NH0xxx	ABC-DEF	3.109	2.680	Decreasing	Open Unlined Drain	09-01-16	9.87363	78.02744
NH0xxx	ABC-DEF	3.320	3.109	Decreasing	Covered Line Drain	09-01-16	9.84857	78.01535
NH0xxx	ABC-DEF	3.917	3.320	Decreasing	Open Unlined Drain	09-01-16	9.83764	78.00392
NH0xxx	ABC-DEF	4.424	4.601	Increasing	Open Unlined Drain	05-01-16	9.83711	77.98576
NH0xxx	ABC-DEF	4.601	5.693	Increasing	Open Unlined Drain	05-01-16	9.83386	77.97729

### 1.11 Median Opening

The following table lists the fields which need to be populated for the 'Median Opening' attribute. The descriptions of the fields are given below.

Field	Description	Example
NH Number	New National Highway number	NH0065
Section Code	Code indicating starting and ending locations of section	HYD-VIJ (Hyderabad-Vijayawada)
Start Chainage	Chainage of the start point (in km)	0.500
End Chainage	Chainage of the end point (in km)	1.500
Direction	Direction of survey Increasing (chainage)	Increasing
Median Type	Type of median, classified into one of the below categories  Raised; Depressed; Barrier; None.	Raised

Median Width	Width of the median in metres, rounded to one place after decimal	0.5
Survey Date	Date of survey in the format <DD-MM-YY>	06-05-17
Latitude	Latitude of survey point	9.98897
Longitude	Longitude of survey point	78.02671

A sample output is shown below for reference:

NHNumber	Section Code	Start Chainage	End Chainage	Direction	Median Type	Median Width	Survey Date	Latitude	Longitude
NH00xx	ABC-DEF	0.000	0.794	Both	Raised	0.5	05-01-16	9.98897	78.02671
NH00xx	ABC-DEF	0.794	1.000	Both	Raised	0.5	05-01-16	9.98444	78.02934
NH00xx	ABC-DEF	1.000	2.810	Both	NoMedian	0.0	05-01-16	9.98341	78.03004
NH00xx	ABC-DEF	2.810	4.335	Both	Raised	1.5	05-01-16	9.98107	78.03078
NH00xx	ABC-DEF	4.335	6.666	Both	NoMedian	0.0	05-01-16	9.96328	78.04160
NH00xx	ABC-DEF	6.666	12.906	Both	NoMedian	0.0	05-01-16	9.95385	78.05255

### 1.12 Right Of Way

The following table lists the fields which need to be populated for the 'Right of Way' attribute. The descriptions of the fields are given below.

Field	Description	Example
NH Number	New National Highway number	NH0065
Section Code	Code indicating starting and ending locations of section	HYD-VIJ (Hyderabad-Vijayawada)
Start Chainage	Chainage of the start point (in km)	0.500
End Chainage	Chainage of the end point (in km)	1.500
Direction	Direction of survey Increasing (chainage) Decreasing (chainage)	Increasing
Row Width	Width of Right of Way (in metres)	24
Remarks		
Survey Date	Date of survey in the format <DD-MM-YY>	06-05-17
Latitude	Latitude of survey point	9.98897
Longitude	Longitude of survey point	78.02671

A sample output is shown below for reference:

NHNumber	Section Code	Start Chainage	End Chainage	Direction	ROW Width	Remarks	Survey Date	Latitude	Longitude
NH0xxx	ABC-DEF	0.000	1.000	Increasing	28		05-05-15	9.98897	78.02671
NH0xxx	ABC-DEF	1.000	2.000	Increasing	24		05-05-15	9.98444	78.02934
NH0xxx	ABC-DEF	2.000	3.000	Increasing	30		05-05-15	9.98341	78.03004
NH0xxx	ABC-DEF	3.000	4.000	Increasing	26		05-05-15	9.98107	78.03078
NH0xxx	ABC-DEF	4.000	11.000	Increasing	24		05-05-15	9.96328	78.04160

## Pavement composition

The following table lists the fields which need to be populated for the 'Pavement composition' attribute. The descriptions of the fields are given below.

Field	Description	Example
NH Number	New National Highway number	NH0065
Section Code	Code indicating starting and ending locations of section	HYD-VIJ (Hyderabad-Vijayawada)
Start Chainage	Chainage of the start point (in km)	0.500
End Chainage	Chainage of the end point (in km)	1.500
Direction	Direction of survey Increasing (chainage) Decreasing (chainage)	Increasing
Pavement Type	Type of pavement Asphalt Cement concrete	Asphalt
Bituminous Surface Course	Type of bituminous surface course	BC
Bituminous Surface Course	Thickness of BSC layer in mm	40
BSC Construction Year	Year of construction of BSC layer in flexible pavements	2015
Bituminous Base Course	Type of bituminous base course	DBM
Bituminous Base Course Thick—	Thickness of BBC layer in mm	100
BBC Construction Year	Year of construction of BBC layer in flexible pavements	2015
Granular Base Type	Type of granular base	WMM
Granular Base Thick-ness	Thickness of GB layer in mm	250
GB Construction Year	Year of construction of GB layer in flexible pavements	2015
Pavement Quality	Type of pavement quality concrete	PQC
Pavement Quality Concrete Thickness	Thickness of PQC layer in mm	300
PQC Construction Year	Year of construction of PQC layer in rigid pavements	2015
Dry Lean Concrete	Thickness of DLC layer in mm	100
Dry Lean Concrete Type	Type of dry lean concrete	DLC
DLC Construction Year	Year of construction of DLC layer in rigid pavements	2015
Granular Sub Base Type	Type of granular sub base	GSB
Granular Sub Base Thickness	Thickness of GSB layer in mm	200
GSB Construction Year	Year of construction of GSB layer	2014
Design CBR	Design CBR of the subgrade, expressed in %	5%
Survey Date	Date of survey in the format <DD-MM-YY>	06-05-17
Latitude	Latitude of survey point	9.98897

Longitude	Longitude of survey point	78.02671
-----------	---------------------------	----------

A sample output is shown below for reference:

NH No.	Section Code	Start Chainage	End Chainage	Direction	Pavement Type	Bituminous Surface Course Type	Bituminous Surface Course Thickness	BSC Construction Year	Bituminous Base Course	Bituminous Base Course Thickness	BBC Construction Year	Granular Base Type	Granular Base Thickness
NH00x	ABC-DEF	0.0	5.0	Both side	Asphalt	BC	40.0	2015	DBM	100	2015	WM	250
NH00x	ABC-DEF	5.0	11.0	Both side	Asphalt	BC	40.0	2015	DBM	80	2015	WM	250
NH00x	ABC-DEF	11.0	20.0	Both side	Asphalt	SDBC	25.0	2015	BM	115	2015	WM	250
NH00x	ABC-DEF	20.0	22.0	Both side	Asphalt	BC	40.0	2015	DBM	100	2015	WM	250
NH00x	ABC-DEF	22.0	30.0	Both side	Asphalt	SDBC	25.0	2015	BM	115	2015	WM	250
NH00x	ABC-DEF	30.0	31.0	Both side	Asphalt	BC	40.0	2015	DBM	100	2015	WM	250

(table continued...)

GB Construction Year	Pavement Quality Concrete Type	Pavement Quality Concrete Thickness	PQC Construction Year	Dry Lean Concrete Thickness	Dry Lean Concrete Type	DLC Construction Year	Granular SubBase Type	Granular SubBase Thickness	GSB Construction Year	Design CBR	Survey Date	Latitude	Longitude
2015	NA	NA	NA	NA	NA	NA	GSB	300	2015	5%	0155	9.99	78.03
2015	NA	NA	NA	NA	NA	NA	GSB	300	2015	5%	0155	9.98	78.03
2015	NA	NA	NA	NA	NA	NA	GSB	300	2015	5%	0155	9.98	78.03
2015	NA	NA	NA	NA	NA	NA	GSB	300	2015	5%	0155	9.98	78.03
2015	NA	NA	NA	NA	NA	NA	GSB	300	2015	5%	0155	9.96	78.04
2015	NA	NA	NA	NA	NA	NA	GSB	300	2015	5%	0155	9.95	78.05

#### 1.14 Carriageway Furniture

The following table lists the fields which need to be populated for the 'Carriageway Furniture' attribute. The descriptions of the fields are given below.

Field	Description	Example
NH Number	New National Highway number	NH0065
Section Code	Code indicating starting and ending locations of section	HYD-VIJ (Hyderabad-Vijayawada)
Chainage	Chainage of the point (in km)	0.500
Direction	Direction of survey Increasing (chainage) Decreasing (chainage)	Increasing

Wayside Amenity Type	Wayside amenities classified into one of the below categories: Crash barriers Signs Street Lights Km stone	Road sign
Survey Date	Date of survey in the format <DD-MM-YY>	06-05-17
Latitude	Latitude of survey point	9.98897
Longitude	Longitude of survey point	78.02671

A sample output is shown below for reference:

NHNumber	SectionCode	Chainage	Direction	EventType	SurveyDate	Latitude	Longitude
NH00xx	ABC-DEF	0.012	Increasing	Street Light Start	03-01-16	9.98897	78.02671
NH00xx	ABC-DEF	0.287	Increasing	Street Light End	03-01-16	9.98444	78.02934
NH00xx	ABC-DEF	2.491	Decreasing	Road Sign	03-01-16	9.98341	78.03004
NH00xx	ABC-DEF	2.708	Decreasing	Road Sign	03-01-16	9.98107	78.03078
NH00xx	ABC-DEF	3.496	Increasing	Road Sign	03-01-16	9.96328	78.04160
NH00xx	ABC-DEF	5.160	Increasing	Road Sign	03-01-16	9.95385	78.05255
NH00xx	ABC-DEF	5.356	Decreasing	Road Sign	03-01-16	9.93102	78.05648
NH00xx	ABC-DEF	8.402	Decreasing	Road Sign	03-01-16	9.91229	78.04961
NH00xx	ABC-DEF	10.966	Decreasing	Road Sign	03-01-16	9.89041	78.03458

### 1.15 Wayside Amenities

The following table lists the fields which need to be populated for the 'Wayside Amenities' attribute. The descriptions of the fields are given below.

Field	Description	Example
NH Number	New National Highway number	NH0065
Section Code	Code indicating starting and ending locations of section	HYD-VIJ (Hyderabad-Vijayawada)
Chainage	Chainage of the point (in km)	0.500
Direction	Direction of survey Increasing (chainage) Decreasing (chainage)	Increasing
Wayside Amenity	Wayside amenities classified into one of the below categories: Bus shelter; Culverts; Restaurant/Motel; Toilet/Public convenience; Rest Rooms for short stay; Toll Plaza; First aid/Medical centre;	Restaurant/Motel

Field	Description	Example
	Telephone booth; Petrol pump/minor repair shop (optional); Police Station; Temple /Mosque; Bridges.	
Survey Date	Date of survey in the format <DD-MM-YY>	06-05-17
Data Source		
Remarks		
Latitude	Latitude of survey point	9.98897
Longitude	Longitude of survey point	78.02671

A sample output is shown below for reference:

NH Number	Section Code	Chainage	Direction	Wayside Amenity	Survey Date	Data Source	Remarks	Latitude	Longitude
NH00xx	ABC-DEF	0.650	Increasing	Restaurant/Motel	05-01-16			9.98897	78.02671
NH00xx	ABC-DEF	1.998	Increasing	Restaurant/Motel	05-01-16			9.98444	78.02934
NH00xx	ABC-DEF	5.524	Increasing	Petrol Pump	05-01-16			9.98341	78.03004
NH00xx	ABC-DEF	11.413	Increasing	Restaurant/Motel	05-01-16			9.98107	78.03078

### 1.16 Land Use

The following table lists the fields which need to be populated for the 'Land Use' attribute. The descriptions of the fields are given below.

Field	Description	Example
NH Number	New National Highway number	NH0065
Section Code	Code indicating starting and ending locations of section	HYD-VIJ (Hyderabad-Vijayawada)
Start Chainage	Chainage of the start point (in km)	0.500
End Chainage	Chainage of the end point (in km)	1.500
Direction	Direction of survey Increasing (chainage) Decreasing (chainage)	Increasing
Land Use	Land use classified into one of the below categories: <ul style="list-style-type: none"> <li>Residential;</li> <li>Commercial;</li> <li>Industrial;</li> <li>Agricultural;</li> <li>Water bodies;</li> <li>Mixed.</li> </ul>	Commercial
Survey Date	Date of survey in the format <DD-MM-YY>	06-05-17
Latitude	Latitude of survey point	9.98897
Longitude	Longitude of survey point	78.02671

A sample output is shown below for reference:

NHNumber	SectionCode	StartChainage	EndChainage	Direction	LandUse	SurveyDate	Latitude	Longitude
NH00xx	ABC-DEF	0.000	0.797	Increasing	Mixed	03-01-16	9.98897	78.02671
NH00xx	ABC-DEF	0.511	0	Decreasing	Mixed	03-01-16	9.98444	78.02934
NH00xx	ABC-DEF	0.797	2.699	Increasing	Mixed	03-01-16	9.98341	78.03004
NH00xx	ABC-DEF	0.835	0.511	Decreasing	Mixed	03-01-16	9.98107	78.03078
NH00xx	ABC-DEF	0.987	0.835	Decreasing	Mixed	03-01-16	9.96328	78.04160
NH00xx	ABC-DEF	1.641	0.987	Decreasing	Agriculture	03-01-16	9.95385	78.05255
NH00xx	ABC-DEF	2.081	1.641	Decreasing	Barren Land	03-01-16	9.93102	78.05648
NH00xx	ABC-DEF	2.378	2.081	Decreasing	Agriculture	03-01-16	9.91229	78.04961
NH00xx	ABC-DEF	2.458	2.378	Decreasing	Agriculture	03-01-16	9.89041	78.03458
NH00xx	ABC-DEF	2.699	3.234	Increasing	Agriculture	03-01-16	9.88489	78.02995

## SECTION 2 - ROAD CONDITION DATA

Road condition data consists of parameters which directly affect maintenance requirements of the road. These parameters are dynamic in nature, and therefore a survey to update this dataset shall be conducted annually for FWD testing and every six months as per Annexure IV for network survey vehicle testing. The first survey shall be conducted at the time of completion testing and the remaining surveys shall be conducted as per the defined frequency.

As an example, if majority of highway length (>50%) passes through a state, where defined survey months are May and November, if completion testing is conducted in April, then the first network survey shall be conducted in the month of April. This shall be considered as the network survey to be conducted in the month of May. The 2nd survey shall be conducted in the month of November, the 3rd survey shall be conducted in the month of May and so on. As regards FWD, the first test/survey shall be conducted at the time of completion in April. The 2nd test/survey shall be conducted in April of next year and so on.

The road condition data shall be used to update specific worksheets, which are listed below.

### 2.1 Visual condition

The following table lists the fields which need to be populated for the 'Visual Condition' attribute. The descriptions of the fields are given below.

Field	Description	Example
NH Number	New National Highway number	NH0065

Field	Description	Example
Section Code	Code indicating starting and ending locations of section	HYD-VIJ (Hyderabad-Vijayawada)
Start Chainage	Chainage of the start point (in	0.500
End Chainage	Chainage of the end point (in	1.500
Direction	Direction of survey Increasing (chainage) Decreasing	Increasing
Lane Number	Number of the lane: L1, L2, R1, R2, etc., L1 being 1st lane on the left from centreline of carriageway, L2 being 2nd lane on the left from centerline and so on	L1
Ravelling	Percent of pavement area affected by ravelling, which is converted to the following rating scale: 1 - Very Poor (> 30%) 2 - Poor (11-30%) 3 - Fair (6-10%) 4 - Good (1-5%)	2
Pot Holes	No. of potholes, which is converted to the following rating scale: 1 - Very Poor (> 5) 2 - Poor (3-5) 3 - Fair (2) 4 - Good (1) 5 - Very Good (0)	1
Edge Break	Pavement area containing edge breaks, which is converted to the following rating scale: 1 - Very Poor (> 5m <sup>2</sup> ) 2 - Poor (1-5m <sup>2</sup> ) 3 - Fair (0.5-1m <sup>2</sup> ) 4 - Good (0-0.5m <sup>2</sup> ) 5 - Very Good (0m <sup>2</sup> )	3
Cracking	Percent of pavement area affected by cracking, which is converted to the following rating scale: 1 - Very Poor (> 30%) 2 - Poor (21-30%) 3 - Fair (11-20%) 4 - Good (5-10%) 5 - Very Good (<5%)	3

Disintegration	Percent of pavement area affected by disintegration, which is converted to the following rating scale: 1 - Very Poor (> 50%) 2 - Poor (20-50%) 3 - Fair (10-20%) 4 - Good (1-10%) 5 - Very Good (<1%)	2
----------------	----------------------------------------------------------------------------------------------------------------------------------------------------------------------------------------------------------------------	---

Field	Description	Example
Depression	Percent of pavement area affected by depression, which is converted to the following rating scale: 1 - Very Poor (> 5%) 2 - Poor (3-5%) 3 - Fair (1-2%) 4 - Good (0-1%) 5 - Very Good (0)	5
Bleeding	Percent of pavement area affected by bleeding, which is converted to the following rating scale: 1 - Very Poor (> 50%) 2 - Poor (20-50%) 3 - Fair (10-20%) 4 - Good (1-10%) 5 - Very Good (<1%)	3
Patching	Percent of pavement area affected by patching, which is converted to the following rating scale: 1 - Very Poor (> 30%) 2 - Poor (16-30%) 3 - Fair (6-15%) 4 - Good (2-5%) 5 - Very Good (<2%)	4
Drain Condition	Condition of the drain, which is converted to the following rating scale: 1 - Poor 2 - Fair 3 - Good	2
Shoulder Condition	Condition of the shoulder, which is converted to the following rating scale: 1 - Poor 2 - Fair 3 - Good	Fair
Survey Date	Date of survey in the format <DD-MM-YY>	06-05-17
Latitude	Latitude of survey point	9.98897
Longitude	Longitude of survey point	78.02671

A sample output is shown below for reference:

NHNumber	Section	Start Chainage	End Chainage	Direction	Lane Number	Ravelling	PotHoles	EdgeBreak	Cracking
NH00xx	ABC-DEF	0.000	0.500	Increasing	L1	4	4	4	4



5	5	5	5	2	2	06-05-17	9.77426	77.98129
5	4	4	4	2	2	06-05-17	9.73071	77.97999
5	5	5	3	2	2	06-05-17	9.68686	77.97017

## 2.2 Roughness

The following table lists the fields which need to be populated for the 'Roughness' attribute. The descriptions of the fields are given below.

Field	Description	Example
NH Number	New National Highway number	NH0065
Section Code	Code indicating starting and ending locations of section	HYD-VIJ (Hyderabad-Vijayawada)

Field	Description	Exa
Start Chainage	Chainage of the start point (in km)	0.500
End Chainage	Chainage of the end point (in km)	1.500
Direction	Direction of survey Increasing (chainage) Decreasing (chainage)	Increasing
Lwplri	International roughness index (IRI) of left wheel path measured from laser profilometer	2.33
Rwplri	International roughness index (IRI) of right wheel path measured from laser profilometer	1.97
Lanelri	Average of the International roughness index (IRI) of left and right wheel paths	2.15
Speed	Speed of vehicle in km/h	42
Survey Date	Date of survey in the format <DD-MM-YYYY>	06-05-17
Latitude	Latitude of survey point	9.98897
Longitude	Longitude of survey point	78.02671

A sample output is shown below for reference:

NH Number	Section Code	Start Chainage	End Chainage	Direction	Lane Number	Lwplri	Rwplri	Lanelri	Speed	Survey Date	Latitude	Longitude
NH00xx	ABC-DEF	0.0	0.1	Increasing	L1	3.31	5.16	4.24	20	06-05-17	9.98897	78.02671
NH00xx	ABC-DEF	0.1	0.2	Increasing	L1	2.81	3.54	3.18	37	06-05-17	9.98444	78.02934
NH00xx	ABC-DEF	0.2	0.3	Increasing	L1	2.31	1.92	2.12	42	06-05-17	9.98341	78.03004
NH00xx	ABC-DEF	0.3	0.4	Increasing	L1	2.17	2.37	2.27	46	06-05-17	9.98107	78.03078
NH00xx	ABC-DEF	0.4	0.5	Increasing	L1	2.11	1.72	1.92	42	06-05-17	9.96328	78.04160
NH00xx	ABC-DEF	0.5	0.6	Increasing	L1	2.33	1.97	2.15	49	06-05-17	9.95385	78.05255
NH00xx	ABC-DEF	0.6	0.7	Increasing	L1	2.37	2.00	2.19	42	06-05-17	9.93102	78.05648
NH00xx	ABC-DEF	0.7	0.8	Increasing	L1	2.15	2.17	2.16	33	06-05-17	9.91229	78.04961
NH00xx	ABC-DEF	0.8	0.9	Increasing	L1	2.45	2.05	2.25	32	06-05-17	9.89041	78.03458

NH00xx	ABC-DEF	0.9	1.0	Increasing	L1	2.18	2.51	2.35	48	06-05-17	9.88489	78.02995
--------	---------	-----	-----	------------	----	------	------	------	----	----------	---------	----------

### 2.3 Rutting

The following table lists the fields which need to be populated for the 'Rutting' attribute. The descriptions of the fields are given below.

Field	Description	Example
NH Number	New National Highway number	NH0065
Section Code	Code indicating starting and ending locations of section	HYD-VIJ (Hyderabad-Vijayawada)
Start Chainage	Chainage of the start point (in km)	0.500

Field	Description	Example
End Chainage	Chainage of the end point (in km)	1.500
Direction	Direction of survey Increasing (chainage) Decreasing (chainage)	Increasing
Lane Number	Number of the lane: L1, L2, R1, R2, etc., L1 being 1st lane on the left from centreline of carriageway. L2 being 2nd lane on the left from	L1
Rutting Left	Rut depth in mm, measured from left wheel	20
Rutting Right	Rut depth in mm, measured from left wheel	18
Rutting Avg	Average rut depth measured from left and right wheel paths	19
Speed	Speed of vehicle in km/h	42
Survey Date	Date of survey in the format <DD-MM-YYYY>	06-05-17
Latitude	Latitude of survey point	9.98897
Longitude	Longitude of survey point	78.02671

A sample output is shown below for reference:

NH Number	Section Code	Start Chainage	End Chainage	Direction	Lane Number	Rutting Left	Rutting Right	Rutting Avg	Speed	Survey Date	Latitude	Longitude
NH00xx	ABC-DEF	0.0	0.5	Increasing	L1	15	14	15	20	06-05-17	9.98897	78.02671
NH00xx	ABC-DEF	0.5	1.0	Increasing	L1	20	18	19	37	06-05-17	9.98444	78.02934
NH00xx	ABC-DEF	1.0	1.5	Increasing	L1	10	8	9	42	06-05-17	9.98341	78.03004
NH00xx	ABC-DEF	1.5	2.0	Increasing	L1	5	6	6	46	06-05-17	9.98107	78.03078
NH00xx	ABC-DEF	2.0	2.5	Increasing	L1	10	10	10	42	06-05-17	9.96328	78.04160
NH00xx	ABC-DEF	2.5	3.0	Increasing	L1	7	5	6	49	06-05-17	9.95385	78.05255
NH00xx	ABC-DEF	3.0	3.5	Increasing	L1	20	18	19	42	06-05-17	9.93102	78.05648
NH00xx	ABC-DEF	3.5	4.5	Increasing	L1	5	5	5	33	06-05-17	9.91229	78.04961
NH00xx	ABC-DEF	4.5	5.0	Increasing	L1	5	5	5	32	06-05-17	9.89041	78.03458

## 2.4 Texture Depth

The following table lists the fields which need to be populated for the 'Texture Depth' attribute. The descriptions of the fields are given below.

Field	Description	Example
NH Number	New National Highway number	NH0065
Section Code	Code indicating starting and ending locations of section	HYD-VIJ (Hyderabad-Vijayawada)
Start Chainage	Chainage of the start point (in km)	0.500

Field	Description	Example
End Chainage	Chainage of the end point (in km)	1.500
Direction	Direction of survey Increasing (chainage) Decreasing (chainage)	Increasing
Lane Number	Number of the lane: L1, L2, R1, R2, etc., L1 being 1st lane on the left from centreline of carriageway, L2 being 2nd lane on the left from centerline and so on	L1
Texture Left	Texture depth of pavement in mm, measured from left wheel path	0.40
Texture Right	Texture depth of pavement in mm, measured from left wheel path	0.30
Texture Average	Average texture depth measured from left and right wheel paths	0.35
Speed	Speed of vehicle in km/h	42
Survey Date	Date of survey in the format <DD-MMYYYY>	06-05-17
Latitude	Latitude of survey point	9.98897
Longitude	Longitude of survey point	78.02671

A sample output is shown below for reference:

NH Number	Section Code	Start Chainage	End Chainage	Direction	Lane Number	Texture Left	Texture Right	Texture Average	Speed	Survey Date	Latitude	Longitude
NH00xx	ABC-DEF	0.0	0.5	Increasing	L1	0.40	0.30	0.35	20	06-05-17	9.98897	78.02671
NH00xx	ABC-DEF	0.5	1.0	Increasing	L1	0.60	0.50	0.55	37	06-05-17	9.98444	78.02934
NH00xx	ABC-DEF	1.0	1.5	Increasing	L1	0.80	0.90	0.85	42	06-05-17	9.98341	78.03004
NH00xx	ABC-DEF	1.5	2.0	Increasing	L1	0.40	0.40	0.4	46	06-05-17	9.98107	78.03078
NH00xx	ABC-DEF	2.0	2.5	Increasing	L1	0.30	0.30	0.3	42	06-05-17	9.96328	78.04160
NH00xx	ABC-DEF	2.5	3.0	Increasing	L1	0.70	0.60	0.65	49	06-05-17	9.95385	78.05255
NH00xx	ABC-DEF	3.0	3.5	Increasing	L1	0.40	0.50	0.45	42	06-05-17	9.93102	78.05648
NH00xx	ABC-DEF	3.5	4.5	Increasing	L1	0.90	0.80	0.85	33	06-05-17	9.91229	78.04961

NH00xx	ABC-DEF	4.5	5.0	Increasing	L1	0.40	0.30	0.35	32	06-05-17	9.89041	78.03458
--------	---------	-----	-----	------------	----	------	------	------	----	----------	---------	----------

## 2.5 Skid Resistance

The following table lists the fields which need to be populated for the 'Skid Resistance' attribute. The descriptions of the fields are given below.

Field	Description	Example
NH Number	New National Highway number	NH0065
Section Code	Code indicating starting and ending locations of section	HYD-VIJ (Hyderabad-Vijayawada)

Field	Description	Example
Start Chainage	Chainage of the start point (in km)	0.500
End Chainage	Chainage of the end point (in km)	1.500
Direction	Direction of survey Increasing (chainage) Decreasing (chainage)	Increasing
Lane Number	Number of the lane: L1, L2, R1, R2, etc., L1 being 1st lane on the left from centreline of carriageway, L2 being 2nd lane on the left from centerline and so on	L1
Skid Left	Skid resistance of pavement measured as skid number, measured from left wheel path	25
Skid Right	Skid resistance of pavement measured as skid number, measured from right	24
Skid Average	Average skid resistance measured from left and right wheel paths	24.5
Speed	Speed of vehicle in km/h	42
Survey Date	Date of survey in the format <DD-MM-YYYY>	06-05-17
Latitude	Latitude of survey point	9.98897
Longitude	Longitude of survey point	78.02671

A sample output is shown below for reference:

NH Number	Section Code	Start Chainage	End Chainage	Direction	Lane Number	Skid Left	Skid Right	Skid Average	Speed	Survey Date	Latitude	Longitude
NH00xx	ABC-DEF	0.0	0.5	Increasing	L1	25.0	24.0	24.5	20	06-05-17	9.98897	78.02671
NH00xx	ABC-DEF	0.5	1.0	Increasing	L1	23.0	23.0	23.0	37	06-05-17	9.98444	78.02934
NH00xx	ABC-DEF	1.0	1.5	Increasing	L1	23.0	24.0	23.5	42	06-05-17	9.98341	78.03004
NH00xx	ABC-DEF	1.5	2.0	Increasing	L1	22.0	22.0	22.0	46	06-05-17	9.98107	78.03078
NH00xx	ABC-DEF	2.0	2.5	Increasing	L1	20.0	21.0	20.5	42	06-05-17	9.96328	78.04160
NH00xx	ABC-DEF	2.5	3.0	Increasing	L1	24.0	24.0	24.0	49	06-05-17	9.95385	78.05255
NH00xx	ABC-DEF	3.0	3.5	Increasing	L1	28.0	28.0	28.0	42	06-05-17	9.93102	78.05648
NH00xx	ABC-DEF	3.5	4.5	Increasing	L1	21.0	21.0	21.0	33	06-05-17	9.91229	78.04961
NH00xx	ABC-DEF	4.5	5.0	Increasing	L1	25.0	24.0	24.5	32	06-05-17	9.89041	78.03458

## 2.6 Falling Weight Deflectometer (FWD)

The following table lists the fields which need to be populated for the 'FWD' attribute. The descriptions of the fields are given below.

Field	Description	Example
NH Number	New National Highway number	NH0065

Field	Description	Example
Section Code	Code indicating starting and ending locations of section	HYD-VIJ (Hyderabad-Vijayawada)
Chainage	Chainage of survey point (in km)	0.500
Direction	Direction of survey Increasing (chainage) Decreasing (chainage)	Increasing
Lane Number	Number of the lane: L1, L2, R1, R2, etc., L1 being 1st lane on the left from centreline of carriageway, L2 being 2nd lane on the left from centerline and so on	L1
Air Temperature	Air temperature recorded in °C	33
Surface Temperature	Temperature of the pavement surface, recorded in °C	39.3
Peak Load	Peak impulse load, measured in kN	45.7
Deflection0	Surface deflection at the test load center, measured in micron	246
Deflection1	Surface deflection at location 1 from the test load center, measured in micron	110
Distance1	Distance of location 1 from the test load center	300
Deflection2	Surface deflection at location 2 from the test load center, measured in micron	153
Distance2	Distance of location 2 from the test load center	600
Deflection3	Surface deflection at location 3 from the test load center, measured in micron	110
Distance3	Distance of location 3 from the test load center	900
Deflection4	Surface deflection at location 4 from the test load center, measured in micron	76
Distance4	Distance of location 4 from the test load center	1200
Deflection5	Surface deflection at location 5 from the test load center, measured in micron	59
Distance5	Distance of location 5 from the test load center	1500
Deflection6	Surface deflection at location 6 from the test load center, measured in micron	44
Distance6	Distance of location 6 from the test load center	1800
Deflection7	Surface deflection at location 7 from the test load center, measured in micron	35
Distance7	Distance of location 7 from the test load center	2100
Deflection8	Surface deflection at location 8 from the test load center, measured in micron	28
Distance8	Distance of location 8 from the test load center	2400
Elastic Modulus	Elastic modulus of bituminous layer, back calculated in MPa	3359
Elastic Modulus	Elastic modulus of granular layer, backcalculated in MPa	396
Elastic Modulus	Elastic modulus of subgrade, back calculated in MPa	90

Field	Description	Example
Corrected Elastic Modulus	Corrected elastic modulus of bituminous layer in MPa	3424
Corrected Elastic Modulus	Corrected elastic modulus of granular layer in MPa	300
Corrected Elastic Modulus SubGrade E3	Corrected elastic modulus of subgrade in MPa	69
Bituminous Layer	Thickness of bituminous layer in mm	105
Base Layer	Thickness of base layer in mm	230
GSB Layer	Thickness of GSB layer in mm	200
Subgrade CBR	CBR of subgrade	0.08
Bituminous Layer Coefficient A1	Layer coefficient of the bituminous layer	0.36
Base Layer Coefficient A2	Layer coefficient of the base layer	0.17
Granular Base Layer Coefficient A3	Layer coefficient of the GSB layer	0.17
Structural Number	Structural number of the pavement	3.86
Modified Structural	Modified structural number including contribution from subgrade	4.85
Survey Date	Date of survey in the format <DD-MM-YY>	06-05-17
Latitude	Latitude of survey point	9.98897
Longitude	Longitude of survey point	78.02671

A sample output is shown below for reference:

NH Number	Section Code	Chainage	Direction	Lane Number	Air Temperature	Surface Temperature	Peak Load	Deflection 0	Deflection 1	Location 1	Deflection 2
NH00xx	ABC-DEF	0.500	RHS	R2	32.6	43.7	45.7	333	188	300	243
NH00xx	ABC-DEF	1.000	LHS	L1	29.9	32.6	45.4	317	163	300	217
NH00xx	A B	1.499	RHS	R1	33.0	39.3	45.7	246	110	300	153
NH00xx	ABC-DEF	2.000	LHS	L2	28.7	32.4	46.0	293	130	300	187
NH00xx	A B	2.500	RHS	R2	33.7	45.8	45.3	429	232	300	316
NH00xx	ABC-DEF	3.000	LHS	L1	29.0	33.0	45.7	343	204	300	252
NH00xx	ABC-DEF	3.500	RHS	R1	33.5	45.4	44.5	373	194	300	268
NH00xx	A B	4.010	LHS	L2	28.9	33.5	45.0	348	201	300	254
NH00xx	ABC-DEF	4.500	RHS	R2	33.3	40.3	46.0	393	241	300	301

(table continued...)

Location 2	Deflection 3	Location 3	Deflection 4	Location 4	Deflection 5	Location 5	Deflection 6	Location 6	Deflection 7	Location 7	Deflection 8
600	180	900	128	1200	102	1500	75	1800	58	2100	42
600	158	900	104	1200	70	1500	48	1800	38	2100	28
600	110	900	76	1200	59	1500	44	1800	35	2100	28
600	126	900	81	1200	62	1500	44	1800	32	2100	23
600	227	900	152	1200	116	1500	86	1800	71	2100	58
600	196	900	144	1200	117	1500	85	1800	65	2100	48
600	187	900	118	1200	83	1500	47	1800	31	2100	22
600	198	900	135	1200	105	1500	64	1800	42	2100	26
600	231	900	162	1200	123	1500	82	1800	62	2100	46

(table continued...)

Location 8	Elastic Modulus Bituminous E1	Elastic Modulus Granular E2	Elastic Modulus Subgrade E3	Corrected Elastic Modulus Bituminous E1	Corrected Elastic Modulus Granular E2	Corrected Elastic Modulus Subgrade E3	Bituminous Layer	Base Layer	GSBLayer	Subgrade CB R
2400	6213	185	100	6447	135	78	105	230	200	0.08
2400	5356	195	100	5295	143	78	105	230	200	0.08
2400	3359	396	90	3424	300	69	105	230	200	0.08
2400	4830	226	100	4770	169	78	105	230	200	0.08
2400	4570	137	97	4781	93	75	105	230	200	0.08
2400	8454	135	100	8374	91	78	105	230	200	0.08
2400	4394	165	100	4590	117	78	105	230	200	0.08
2400	7817	139	96	7762	95	74	105	230	200	0.08
2400	7666	123	95	7847	81	73	105	230	200	0.08

(table continued...)

Bituminous Layer Coefficient A1	Base Layer Coefficient A2	Granular Base Layer Coefficient A3	Structural Number	Modified Structural Number	Survey Date	Latitude	Longitude
0.45	0.13	0.13	3.68	4.82	01-07-16	9.98897	78.02671
0.42	0.13	0.13	3.56	4.70	23-06-16	9.98444	78.02934
0.36	0.17	0.17	3.86	4.85	01-07-16	9.98341	78.03004
0.41	0.14	0.14	3.65	4.79	23-06-16	9.98107	78.03078
0.41	0.11	0.11	3.24	4.34	01-07-16	9.96328	78.04160
0.49	0.11	0.11	3.58	4.72	23-06-16	9.95385	78.05255
0.40	0.12	0.12	3.34	4.48	01-07-16	9.93102	78.05648
0.48	0.12	0.12	3.67	4.75	23-06-16	9.91229	78.04961
0.48	0.11	0.11	3.53	4.59	01-07-16	9.89041	78.03458

## 2.7

### Falling Weight Deflectometer (FWD) Rigid

The following table lists the fields which need to be populated for the 'FWD Rigid' attribute. The descriptions of the fields are given below.

Field	Description	Example
NH Number	New National Highway number	NH0065
Section Code	Code indicating starting and ending locations of section	HYD-VIJ (Hyderabad-Vijayawada)
Chainage	Chainage of the point (in km)	0.500
Direction	Direction of survey Increasing (chainage) Decreasing (chainage)	Increasing
Lane Number	Number of the lane: L1, L2, R1, R2, etc.	L2
Air Temperature	Air temperature recorded in °C	30.1
Surface Temperature	Temperature of the pavement surface, recorded in °C	39.4
Peak Load	Peak impulse load, measured in kN	103.7
Deflection1	Surface deflection at the test load center, measured in micron	140
Deflection2	Surface deflection at 300 mm from the test load center, measured in micron	121
Deflection3	Surface deflection at 600 mm from the test load center, measured in micron	108
Deflection4	Surface deflection at 900 mm from the test load center, measured in micron	101
Concrete Slab Thickness	Thickness of concrete slab, measured in mm	300
Area of Deflection Basin	Area of deflection basin, calculated from measured deflections, in cm <sup>2</sup>	761
Radius of Relative Stiffness	Radius of relative stiffness, calculated in mm	823
Normalized Deflection1	Normalized deflection at location 1, in mm	3.1
Normalized Deflection 2	Normalized deflection at location 2, in mm	2.9
Normalized Deflection 3	Normalized deflection at location 3, in mm	2.4
Normalized Deflection 4	Normalized deflection at location 4, in mm	1.9
Modulus of Subgrade Reaction k	Modulus of subgrade reaction, measured in MPa/m	131
Elastic Modulus of Concrete Ec	Elastic modulus of concrete, calculated in MPa	26118
Cube Strength of Concrete fck	Cube strength of concrete, calculated in MPa	27
Flexural strength of concrete fmr	Flexural strength of concrete, calculated in MPa	3.7
Date Of Testing	Date of testing in the format <DD-MM-YY>	06-05-17

Latitude	Latitude of survey point	9.98897
Longitude	Longitude of survey point	78.02671

A sample output is shown below for reference:

NH No	Section Code	Chain -age	Direction	Lane No.	Air Temperature	Surface Temperature	Peak Load	Deflection1	Deflection2	Deflection3	Deflection4	Concrete Slab Thickness
NH00x	ABC-DEF	0.0	LHS	L2	29.0	34.9	104.1	167	143	130	119	300
NH00x	ABC-DEF	0.5	RHS	R2	30.5	38.1	104.4	141	130	122	115	300
NH00x	ABC-DEF	1.0	LHS	L1	30.0	35.6	105.2	147	111	100	91	300
NH00x	ABC-DEF	1.5	RHS	R1	28.9	38.3	102.4	140	126	116	107	300
NH00x	ABC-DEF	2.0	LHS	L2	30.1	39.4	103.7	140	121	108	101	300
NH00x	ABC-DEF	2.5	RHS	R2	29.0	37.5	104.6	150	134	126	117	300
NH00x	ABC-DEF	3.0	LHS	L1	30.6	38.9	102.7	124	109	104	92	300
NH00x	ABC-DEF	3.5	RHS	R1	29.3	39.1	105.9	149	136	128	119	300
NH00x	ABC-DEF	4.5	RHS	R2	30.3	41.0	104.9	138	127	121	114	300

(Table continued...)

Area of Deflection Basin	Radius of Relative Stiffness	Normalized Deflection d1	Normalized Deflection d2	Normalized Deflection d3	Normalized Deflection d4	Modulus of Subgrade Reaction k	Elastic Modulus of Concrete Ec	Cube Strength of Concrete fck	Flexural strength of concrete fmr	Date Of Testing	Latitude	Longitude
759	816	3	3	2	2	112	21590	19	3	25-06-16	9.98897	78.02671
821	1214	3	3	3	2	62	58161	135	8	28-06-16	9.98444	78.02934
684	580	3	3	2	1	246	12051	6	2	25-06-16	9.98341	78.03004
796	1014	3	3	3	2	87	39783	63	6	28-06-16	9.98107	78.03078
761	823	3	3	2	2	131	26118	27	4	25-06-16	9.96328	78.04160
800	1040	3	3	3	2	79	39908	64	6	28-06-16	9.95385	78.05255
789	971	3	3	3	2	107	41290	68	6	25-06-16	9.93102	78.05648
814	1150	3	3	3	2	66	50086	100	7	28-06-16	9.91229	78.04961
826	1257	3	3	3	2	59	64082	164	9	28-06-16	9.89041	78.03458

**SECTION 7**

**DRAFT FORM OF CONTRACT**

**Note:** This draft Agreement is a generic document and shall be modified based on particulars of the Project.

<b>S. No</b>	<b>Content</b>	<b>Page No.</b>
<b>I</b>	<b>FORM OF CONTRACT</b>	
<b>II</b>	<b>GENERAL CONDITIONS OF CONTRACT</b>	
<b>1</b>	<b>General Provisions</b>	
1.1	Definitions	
1.2	Relation between the Parties	
1.3	Law Governing the Contract	
1.4	Language	
1.5	Headings	
1.6	Notices	
1.7	Location	
1.8	Authority of Member in charge	
1.9	Authorized Representatives	
1.10	Taxes and Duties	
<b>2</b>	<b>Commencement, Completion, Modification, and Termination of Contract</b>	
2.1	Effectiveness of Contract	
2.2	Termination of Contract for Failure to Become Effective	
2.3	Commencement of Services	
2.4	Expiration of Contract	
2.5	Entire Agreement	
2.6	Modification	
2.7	Force Majeure	
2.7.1	Definitions	
2.7.2	No Breach of Contract	
2.7.3	Measures to be taken	
2.7.4	Extension of Time	
2.7.5	Payments	
2.7.6	Consultation	
2.8	Suspension	
2.9	Termination	
2.9.1	By NHIDCL	
2.9.2	By the Consultants	
2.9.3	Cessation of Rights and Obligations	
2.9.4	Cessation of Services	
2.9.5	Payment upon Termination	
2.9.6	Disputes about Events of Termination	
<b>3</b>	<b>Obligations of the Consultants</b>	
3.1	General	
3.1.1	Standard of Performance	
3.1.2	Law Governing Services	
3.2	Conflict of Interests	
3.2.1	Consultants not to Benefit from Commissions, Discounts, etc.	
3.2.2	Procurement Rules of Funding Agencies	
3.2.3	Consultants and Affiliates Not to Engage in certain Activities	
3.2.4	Prohibition of Conflicting Activities	

3.3	Confidentiality	
3.4	Liability of the Consultants	
3.5	Insurance to be Taken out by the Consultants	
3.6	Accounting, Inspection and Auditing	
3.7	Consultant's Actions requiring NHIDCL's prior Approval	
3.8	Reporting Obligations	
3.9	Documents prepared by the Consultants To Be the Property of NHIDCL	
3.10	Equipment and Materials Furnished by NHIDCL	
<b>4</b>	<b>Consultants' Personnel and Sub-consultants</b>	
4.1	General	
4.2	Description of Personnel	
4.3	Approval of Personnel	
4.4	Working Hours, Overtime, Leave etc.	
4.5	Removal and /or Replacement of Personnel	
4.6	Resident Project Manager	
<b>5</b>	<b>Obligations of NHIDCL</b>	
5.1	Assistance and Exemptions	
5.2	Access to Land	
5.3	Change in the Applicable Law	
5.4	Services, Facilities and Property of NHIDCL	
5.5	Payment	
5.6	Counterpart Personnel	
<b>6</b>	<b>Payments to the Consultants</b>	
6.1	Cost Estimates, Ceiling Amount	
6.2	Remuneration and Reimbursable Expenditures	
6.3	Currency of Payment	
6.4	Mode of Billing and Payment	
<b>7</b>	<b>Fairness and Good Faith</b>	
<b>7.1</b>	Good Faith	
<b>7.2</b>	Operation of the Contract	
<b>III</b>	<b>SPECIAL CONDITIONS OF CONTRACT</b>	
<b>IV</b>	<b>APPENDICES</b>	
Appendix A	Description of the Services	
Appendix B	Reporting Requirements	
Appendix C	Key Personnel and Sub-consultants	
Appendix D	Medical Certificate	
Appendix E	Hours of Work for Key Personnel	
Appendix F	Duties of the NHIDCL	
Appendix G	Cost Estimates	
Appendix H	Form of Performance Bank Guarantee	
Appendix I	Form of Bank Guarantee for Advance Payments	
Appendix J	Letter of invitation	
Appendix K	Letter of Award	
Appendix L	Minutes of pre-bid meeting	
Appendix M	Memorandum of Understanding (in case of JV)	
<b>V</b>	<b>ANNEXURES</b>	

**1. FORM OF CONTRACT**

**COMPLEX TIME BASED ASSIGNMENTS**

This CONTRACT (hereinafter called the "Contract") is made the [...] Day of the Month of [month] 201\_\_, between, on the one hand NHIDCL and, on the other hand [Name of the Consultant] hereinafter called the "Consultants")

*[Note\*: If the Consultants consist of more than one entity, the above should be partially amended to read as follows:*

"...and, on the other hand, a joint venture consisting of the following entities, each of which will be jointly severally liable to NHIDCL for all the Consultants' obligations under this Contract, namely, [Name of the Lead] and [Name of other Partner/Association] (Hereinafter called "Consultants")]

**WHEREAS**

- (a) NHIDCL has requested the Consultants to provide certain consulting services as defined in the General Conditions of Contract attached to this Contract (hereinafter called the "Services");
- (b) the Consultants, having represented to NHIDCL that they have the required professional skills ,and personnel and technical resources ,have agreed to provide the Services on the terms and conditions set forth in this Contract;

NOW THEREFORE the parties hereto hereby agree as follows:

- 1. The following documents attached hereto shall be deemed to form an integral part of this Contract:
  - (a) The General Conditions of Contract (hereinafter called "GC")'
  - (b) The Special Conditions of Contract (hereinafter called "SC");
  - (c) The following Appendices:

[Note: If any of these Appendices are not used, the words "Not Used" should be inserted below next to the title of the Appendix on the sheet attached hereto carrying the title of that Appendix].

Appendix A	Description of the Services
Appendix B	Reporting Requirements
Appendix C	Key Personnel and Sub-consultants
Appendix D	Medical Certificate
Appendix E	Hours of Work for Key Personnel
Appendix F	Duties of NHIDCL
Appendix G	Cost Estimates
Appendix H	Form of Performance Bank Guarantee
Appendix I	Form of Bank Guarantee for Advance Payments
Appendix J	Letter of invitation

Appendix K	Letter of Award
Appendix L	Minutes of pre-bid meeting
Appendix M	Memorandum of Understanding (in case of JV)

2. The mutual rights and obligations of NHIDCL and the Consultants shall be as set forth in the Contract; in particular
- (a) The Consultants shall carry out the Services in accordance with the provisions of the Contract; and
  - (b) NHIDCL shall make payments to the Consultants in accordance with the Provisions of the Contract.

IN WITNESS WHEREOF, the Parties hereto have caused this Contract to be signed in their respective names as of the day and year first above written.

FOR AND ON BEHALF OF NHIDCL	FOR AND ON BEHALF OF [NAME OF THE CONSULTANTS]
By  (Authorized Representative)	By  (Authorized Representative)

[Note: If the Consultants consist of more than one entity, all of these entities should appear as signatures, e.g. in the following manner]

FOR AND ON BEHALF OF NHIDCL	FOR AND ON BEHALF OF EACH OF THE MEMBERS OF THE CONSULTANTS
By  (Authorized Representative)	[Name of the Member]  By  (Authorized Representative)  [Name of the Member]  By  (Authorized Representative)

## GENERAL CONDITIONS OF CONTRACT

### 1. General Provisions

Unless the context otherwise requires, the following terms whenever used in this Contract have the following meanings:

#### 1.1 Definitions

- (a) "Applicable Law" means the laws and any other instruments having the force of law in the Government's country [or in such other country as may be specified in the Special Conditions of Contract (SC)], as they may be issued and in force from time to time.
- (b) "Contract" means the Contract signed by the Parties, to which these General Conditions of Contract are attached, together with all the documents listed in Clause 1 of such signed Contract;
- (c) "Effective Date" means the date on which this Contract comes into force and effect pursuant to Clause GC 2.1;
- (d) 'foreign currency' means any currency other than the currency of the Government;
- (e) 'GC' means these General Conditions of Contract;
- (f) "Government" means the Government of India;
- (g) 'Local currency' means the Indian Rupees;
- (h) "Consultant" wherever mentioned in this Contract Agreement means the "Authority Engineer (AE)" and includes sub-consultants or Associates engaged by the primary consultant.
- (i) "Member", in case the Consultants consist of a joint venture of more than one entity, means any of these entities, and "Members" means all of these entities;
- (j) "Party" means the NHIDCL or the Consultants, as the case may be, and Parties means both of them;
- (k) "Personnel" means persons hired by the Consultants or by any Sub-Consultants and or Associates as Employees and assigned to the performance of the Services

Or any part thereof; "Foreign Personnel" means such persons who at the time of being so hired had their domicile outside India, "Local Personnel" means such persons who at the time of being so hired had their domicile inside the India; and 'key personnel' means the personnel referred to in Clause GC 4.2 (a).

- (l) "SC" means the Special Conditions of Contract by which these General Conditions of Contract may be amended or supplemented;

- (m) "Services" means the work to be performed by the Consultants pursuant to his contract, as described in Appendix A hereto. The scope of work will be strictly as given in various Clauses in TOR. The approach and methodology to be adopted by the Consultant for carrying out the assignment as Authority Engineer may be modified depending on the site requirements and work programme of the EPC Contract or after mutual discussions with NHIDCL, the EPC Contractor and the Authority Engineer. The work plan as indicated by the Consultant may be modified accordingly to the site requirements.
- (n) "Sub-Consultant and or Associates "means any entity to which the Consultants subcontract any part of the Services in accordance with the provisions of Clause GC 3.7; and
- (o) "Third Party" means any person or entity other than the Government, NHIDCL, the Consultants or a Sub-consultant.

## **1.2 Relation between the Parties**

Nothing contained herein shall be construed as establishing a relation of master and servant or of principal and agent as between NHIDCL and the Consultants. The Consultants, subject to this Contract, have complete charge of Personnel and Sub-consultants, if any, performing the Services and shall be fully responsible for the Services performed by them or on their behalf hereunder.

## **1.3 Law Governing Contract**

This Contract, its meaning and interpretation, and the relation between the Parties shall be governed by the Applicable Law.

## **1.4 Language**

This Contract has been executed in the language specified in the SC, which shall be the binding and controlling language for all matters relating to the meaning or interpretation of this Contract.

## **1.5 Headings**

The headings shall not limit, alter or affect the meaning of this Contract.

## **1.6 Notices**

1.6.1 Any notice, request or consent required or permitted to be given or made pursuant to this Contract shall be in writing. Any such notice, request or consent shall be deemed to have been given or made when delivered in person to an authorized representative of the Party to whom the communication is addressed, or when sent by registered mail, telegram or E-Mail to such Party at the address specified in the SC.

1.6.2 Notice will be deemed to be effective as specified in the SC.

1.6.3 A Party may change its address for notice hereunder by giving the other Party notice of such change pursuant to the provisions listed in the SC with respect to Clause GC 1.6.2.

## **1.7 Location**

The Services shall be performed at such locations as are specified in Appendix A hereto and, where the location of a particular task is not so specified, at such locations whether in Government's Country or elsewhere, as NHIDCL may approve.

## **1.8 Authority of Member in Charge**

In case the Consultants consist of a joint venture of more than one entity, the Members hereby authorize the entity specified in the SC to act on their behalf in exercising all the Consultants' rights and obligations towards NHIDCL under this Contract, including without limitation the receiving of instructions and payments from NHIDCL.

## **1.9 Authorized Representatives**

Any action required or permitted to be taken, and any document required or permitted to be executed, under this Contract by NHIDCL or the Consultants may be taken or executed by the officials specified in the SC.

## **1.10 Taxes and Duties**

Unless otherwise specified in the SC, the Consultants, Sub-consultants and Personnel shall pay such taxes, duties, fees and other impositions as may be levied under the Applicable Law. Goods & Service tax as applicable shall be paid to the Authority's Engineer while making payment for services rendered. The consultants shall then deposit the same with the tax authorities and provide a proof of having done so within next 90 days in line with policy circulars issued by NHIDCL.

## **2. Commencement, Completion, Modification and Termination of Contract**

### **2.1 Effectiveness of Contract**

This Contract shall come into force and effect on the date (the "Effective Date") of NHIDCL's notice to the Consultants instructing the Consultants to begin carrying out the Services. This notice shall confirm that the effectiveness conditions, if any, listed in the SC have been met.

### **2.2 Termination of Contract for Failure to Become Effective**

If this Contract has not become effective within such time period after the date of the Contract signed by the Parties as shall be specified in the SC, either Party may, by not less than four (4) weeks' written notice to the other Party, declare this Contract to be null and void, and in the event of such a declaration by either Party, neither Party shall

have any claim against the other Party with respect hereto.

### **2.3 Commencement of Services**

The Consultants shall begin carrying out the Services at the end of such time period after the Effective Date as shall be specified in the SC.

### **2.4 Expiration of Contract**

Unless terminated earlier pursuant to Clause GC2.9 hereof, this Contract shall expire when services have been completed and all payments have been made at the end of such time period after the Effective Date as shall be specified in the SC.

### **2.5 Entire Agreement**

This Contract contains all covenants, stipulations and provisions agreed by the Parties. No agent or representative of either Party has authority to make, and the Parties shall not be bound by or be liable for, any statement, representation, promise or agreement not set forth herein.

### **2.6 Modification**

Modification of the terms and conditions of this Contract, including any modification of the scope of the Services, may only be made by written agreement between the Parties as the case may be, has been obtained. Pursuant to Clause GC 7.2 hereof, however, each Party shall give due consideration to any proposals for modification made by the other Party.

### **2.7 Force Majeure**

#### **2.7.1. Definition**

- (a) For the purposes of this Contract, "Force Majeure" means an event which is beyond the reasonable control of a Party, and which makes a Party's performance of its obligations hereunder impossible or so impractical as reasonably to be considered impossible in the circumstances, and includes, but is not limited to, war, riots, civil disorder, earthquake, fire, explosion, storm, flood or other adverse weather conditions, strikes, lockouts or other industrial action ( except where such strikes, lockouts or other industrial action are within the power of the Party invoking Force Majeure to prevent), confiscation or any other action by government agencies.
- (b) Force Majeure shall not include (i) any event which is caused by the negligence or intentional action of a party or such Party's Sub-consultants or agents or employees, nor (ii) any event which a diligent Party could reasonably have been expected to both(A) take in to account at the time of the conclusion of this Contract and(B) avoid or overcome in the carrying out of its obligations hereunder .

- (c) Force Majeure shall not include insufficiency of funds or failure to make any payment required hereunder.

### **2.7.2 No Breach of Contract**

The failure of a Party to fulfill any of its obligations hereunder shall not be considered to be a breach of, or default under, this Contract insofar as such inability arises from an event of Force Majeure, provided that the Party affected by such an event has taken all reasonable precautions, due care and reasonable alternative measures, all with the objective of carrying out the terms and conditions of this Contract.

### **2.7.3 Measures to be taken**

- (a) A Party affected by an event of Force Majeure shall take all reasonable measures to remove such Party's inability to fulfill its obligations hereunder with a minimum of delay.
- (b) A Party affected by an event of Force Majeure shall notify the other Party of such event as soon as possible, and in any event not later than fourteen (14) days following the occurrence of such event, providing evidence of the nature and cause of such event, and shall similarly give notice of the restoration of normal conditions as soon as possible.
- (c) The Parties shall take all reasonable measures to minimize the consequences of any event of Force Majeure.

### **2.7.4 Extension of Time**

Any period within which a Party shall, pursuant to this Contract, complete any action or task, shall be extended for a period equal to the time during which such Party was unable to perform such action as a result of Force Majeure.

Extension of Time for providing services of the Authority's Engineer shall be extended concurrently with the Extension of Time granted, if any, to the EPC Contractor for the project, subject to satisfactory performance of the Authority's Engineer.

### **2.7.5 Payments**

During the period of their inability to perform the Services as a result of an event of Force Majeure, the Consultants shall be entitled to be reimbursed for additional costs reasonably and necessarily incurred by them during such period for the purposes of the Services and in reactivating the Services after the end of such period.

### **2.7.6 Consultation**

Not later than thirty (30) days after the Consultants, as the result of an event of Force

Majeure, have become unable to perform a material portion of the Services, the Parties shall consult with each other with a view to agreeing on appropriate measures to be taken in the circumstances.

## **2.8. Suspension**

NHIDCL may, by written notice of suspension to the Consultants, suspend all payments to the Consultants hereunder if the Consultants fail to perform any of their obligations under this Contract, including the carrying out of the Services, provided that such notice of suspension (i) shall specify the nature of the failure, and (ii) shall request the Consultants to remedy such failure within a period not exceeding thirty (30) days after receipt by the Consultants of such notice of suspension.

## **2.9 Termination**

### **2.9.1 By NHIDCL**

NHIDCL may, by not less than thirty (30) days' written notice of termination to the Consultants (except in the event listed in paragraph (f) below, for which there shall be a written notice of not less than sixty (60) days), terminate this contract. Such notice to be given after the occurrence of any of the events specified in paragraphs (a) through (h) of this Clause GC 2.9.1.

- (a) if the Consultants fail to remedy a failure in the performance of their obligations hereunder, as specified in a notice of suspension pursuant to Clause GC 2.8 herein above, within thirty (30) days of receipt of such notice of suspension or within such further period as NHIDCL may have subsequently approved in writing;
- (b) If the Consultants become (or, if the Consultants consist of more than one entity, if any of their Members becomes) in solvent or bankrupt or enter into any agreements with their creditors for relief of debt or take advantage of any law for the benefit of debtors or go into liquidation or receivership whether compulsory or voluntary;
- (c) If the Consultants fail to comply with any final decision reached as a result of arbitration proceedings pursuant to Clause GC 8 hereof;
- (d) If the Consultants submit to NHIDCL a statement which has a material effect on the rights, obligations or interests of NHIDCL and which the Consultants know to be false;
- (e) if, as the result of Force Majeure, the Consultants are unable to perform a material portion of the Services for a period of not less than sixty (60) days; or
- (f) if NHIDCL, in its sole discretion and for any reason whatsoever, decides to

terminate this Contract.

- (g) if the consultant, in the judgment of NHIDCL has engaged in corrupt or fraudulent practices in competing for or in executing the Contract. For the purpose of this clause:

"corrupt practice" means the offering, giving, receiving or soliciting of anything of value to influence the action of a public official in the selection process or in contract execution.

"fraudulent practice" means a misrepresentation of facts in order to influence a selection process or the execution of a contract to the detriment of the Borrower, and includes collusive practice among consultants (prior to or after submission of proposals) designed to establish prices at artificial non-competitive levels and to deprive the Borrower of the benefits of free and open competition.

- (h) if EPC Contractor represents to NHIDCL that the Consultant is not discharging his duties in a fair, efficient and diligent manner and if the dispute remains unresolved, NHIDCL may terminate this contract.

2.9.1.1 NHIDCL may, at its discretion, without terminating the contract and allowing the consultant to continue with the existing contract, place the consultant in the Negative List for any of the following reasons : -

- (a) Failure to mobilize at site, the key personnel and sub – professional staff within the time frame of the Contract Agreement or as directed by NHIDCL.
- (b) Frequent replacement of key personnel.
- (c) Failure to deploy all key personnel as per the Contract Agreement.
- (d) Submission of incorrect/ fake CV of personnel.
- (e) Failure to replace in reasonable time frame the key personnel who have left the site or asked to be replaced by NHIDCL due to poor performance/ unprofessional conduct.
- (f) Failure to establish site office and Bio – metric attendance system.
- (g) Failure to review the designs and drawings and other submissions of EPC Contractor in time.
- (h) Failure to examine and recommend release of payments due to the Contractor, EOT and COS proposals, terminations payment etc as per the Contract Agreement or as per the instructions issued by NHIDCL from time to time.
- (i) Incorrect/inaccurate assessment of COS proposals/estimates and termination/final payment.

- (j) Not ensuring quality of works as per the specifications and standards.
- (k) Not conducting requisite tests as per the provisions of the Contract Agreement.
- (l) Not submitting Monthly Inspection Report in time and as per the format in the Contract Agreement.
- (m) Failure to suspend whole or part of the work, if the work threatens the safety of users and pedestrians.
- (n) Failure to submit the completion and/or the provisional completion certificate in time.
- (o) Failure to inspect the site by the key personnel on a regular basis.
- (p) Failure to inspect the site to comply with the maintenance requirement during construction period and during the maintenance period.
- (q) Failure to comply with any other condition of TOR and any other lawful directions of NHIDCL.

Provided that, NHIDCL shall issue a notice giving 15 days time to the consultant before placing him in the 'Negative List' and upon evaluation of reply, if any, shall take a final decision. Such notice shall not be issued without the approval of an officer below the rank of Executive Director.

Provided, upon satisfactory action on the matter for which the Consultant was placed in the list, the NHIDCL may remove the name of the Consultant to be removed from the 'Negative List'.

#### 2.9.1.2 Consequence of placement in the Negative List:-

"The consultant to include all the JV partners and Associates and their related parties shall not be eligible to bid in any of the Authority's Consultancy Contracts for a period of 2 years from date of being placed in the negative list or till the completion of the ongoing consultancy service or till removal from Negative list, whichever is earlier.

### 2.9.2 By the Consultants

The Consultants may, by not less than thirty (30) days' written notice to NHIDCL, terminate this Contract. Such notice to be given after the occurrence of any of the events specified in paragraphs (a) through (d) of this Clause GC2.9.2:

- (a) if NHIDCL fails to pay any money due to the Consultants pursuant to this Contract and not subject to dispute pursuant to Clause 8 hereof within forty-five (45) days after receiving written notice from the Consultants that such payment is overdue;
- (b) if NHIDCL is in material breach of its obligations pursuant to this Contract and has not remedied the same within forty-five (45) days (or such longer period as the Consultants may have subsequently approved in writing) following the

receipt by NHIDCL of the Consultants' notice specifying such breach;

- (c) if, as the result of Force Majeure, the Consultants are unable to perform a material portion of the Services for a period of not less than sixty (60) days; or
- (d) if NHIDCL fails to comply with any final decision reached as a result of arbitration pursuant to Clause GC 8 hereof.

### **2.9.3. Cessation of Rights and Obligations**

Upon termination of this Contract pursuant to Clauses GC 2.2 or GC 2.9 hereof, or upon expiration of this Contract pursuant to Clause GC2.4 hereof, all rights and obligations of the Parties hereunder shall cease, except:

- (i) such rights and obligations as may have accrued on the date of termination or expiration;
- (ii) the obligation of confidentiality set forth in Clause GC 3.3 hereof;
- (iii) the Consultants' obligation to permit inspection, copying and auditing of their accounts and records set forth in Clause GC 3.6 (ii) hereof; and
- (iv) any right which a Party may have under the Applicable Law

### **2.9.4 Cessation of Services**

Upon termination of this Contract by notice of either Party to the other pursuant to Clauses GC2.9.1 or GC2.9.2 hereof, the Consultants shall, immediately upon dispatch or receipt of such notice, take all necessary steps to bring the Services to a close in a prompt and orderly manner and shall make every reasonable effort to keep expenditures for this purpose to a minimum. With respect to documents prepared by the Consultants and equipment and materials furnished by NHIDCL, the Consultants shall proceed as provided, respectively, by Clauses GC 3.9 or GC 3.10 hereof.

### **2.9.5 Payment upon Termination**

Upon termination of this Contract pursuant to Clauses GC 2.9.1 or GC 2.9.2 hereof, NHIDCL shall make the following payments to the Consultants (after offsetting against these payments any amount that may be due from the Consultant to NHIDCL):

- (a) remuneration pursuant to Clause GC 6 hereof for Services satisfactorily performed prior to the effective date of termination;
- (b) reimbursable expenditures pursuant to Clause GC 6 hereof for expenditures actually incurred prior to the effective date of termination; and

- (c) except in the case of termination pursuant to paragraphs (a) through (d) of Clause GC2.9.1 hereof, reimbursement of any reasonable cost incident to the prompt and orderly termination of the Contract including the cost of return travel of the Consultants' personnel and their eligible dependents.

#### **2.9.6. Disputes about Events of Termination**

If either Party disputes whether an event specified in paragraphs (a) through (e) of Clause GC 2.9.1 or in Clause GC2.9.2 hereof has occurred, such Party may, within forty-five (45) days after receipt of notice of termination from the other Party, refer the matter to arbitration pursuant to Clause GC8 hereof, and this Contract shall not be terminated on account of such event except in accordance with the terms of any resulting arbitral award.

### **3. Obligation of the Consultants**

#### **3.1 General**

##### **3.1.1. Standard of Performance**

The Consultants shall perform the Services and carry out their obligations hereunder with all due diligence, efficiency and economy, in accordance with generally accepted professional techniques and practices, and shall observe sound management practices, and employ appropriate advanced technology and safe and effective equipment, machinery, materials and methods "The Consultants shall always" act, in respect of any matter relating to this Contract or to the Services, as faithful advisers to NHIDCL, and shall at all times support and safeguard NHIDCL's legitimate interests in any dealings with Sub-consultants or Third Parties.

##### **3.1.2 Law Governing Services**

The Consultants shall perform the Services in accordance with the Applicable Law and shall take all practicable steps to ensure that any Sub-consultants and or Associates, as well as the Personnel of the Consultants and any Sub-consultants and or Associates, comply with the Applicable Law. NHIDCL shall advise the Consultants in writing of relevant local customs and the Consultants shall, after such notifications, respect such customs.

#### **3.2 Conflict of Interests**

##### **3.2.1 Consultants Not to Benefit from Commissions, Discounts, etc.**

The Remuneration of the Consultants pursuant to Clause GC6 hereof shall constitute the Consultants' sole remuneration in connection with this Contract or the Services and, subject to Clause GC3.2.2 hereof, the Consultants shall not accept for their own benefit any trade commission, discount or similar payment in connection with

activities pursuant to this Contract or to the Services or in the discharge of their obligations hereunder, and the Consultants shall use their best efforts to ensure that any Sub-consultants and or Associates, as well as the Personnel and agents of either of them, similarly shall not receive any such additional remuneration.

**3.2.2** If the Consultants, as part of the Services, have the responsibility of advising NHIDCL on the procurement of goods, works or services, the Consultants shall comply with any applicable procurement guidelines of NHIDCL and or Associates Bank or of the Association, as the case maybe, and other funding agencies and shall at all times exercise such responsibility in the best interest of NHIDCL. Any discounts or commissions obtained by the Consultants in the exercise of such procurement responsibility shall be for the account of NHIDCL.

**3.2.3 Consultants and Affiliates Not to engage in Certain Activities**

The Consultants agree that, during the term of this Contract and after its termination, the Consultants and any entity affiliated with the Consultants, as well as any Sub-Consultant and or Associates and any entity affiliated with such Sub Consultant and or Associates, shall be disqualified from providing goods works or services (other than the Services and any continuation thereof) for any project resulting from or closely related to the Services. .

**3.2.4 Prohibition of Conflicting Activities**

The Consultants shall not engage, and shall cause their Personnel as well as their Sub-consultants and or Associates and their Personnel not to engage, either directly or indirectly, in any of the following activities:

- (a) during the term of this Contract, any business or professional activities in the Government's country which would conflict with the activities assigned to them under this Contract; and
- (b) after the termination of this Contract, such other activities as may be specified in the SC.

**3.3 Confidentiality**

The Consultants, their Sub-consultants and the Personnel of either of them shall not, either during the term or within two (2) years after the expiration of this Contract, disclose any proprietary or confidential information relating to the Project, the Services, this Contract or NHIDCL's business or operations without the prior written consent of NHIDCL.

**3.4 Liability of the Consultants**

Subject to additional provisions, if any, set forth in the SC, the Consultants' liability under this Contract shall be as provided by the Applicable Law.

### **3.5 Insurance to be Taken Out by the Consultants**

The Consultants (i) shall take out and maintain, and shall cause any Sub-consultants to take out and maintain, at their (or the Sub-consultants', as the case may be) own cost but on terms and conditions approved by NHIDCL, insurance against the risks, and for the coverages, as shall be specified in the SC, and (ii) at NHIDCL's request, shall provide evidence to NHIDCL showing that such insurance has been taken out and maintained and that the current premiums therefore have been paid.

### **3.6 Accounting, Inspection and Auditing**

The Consultants(i)shall keep accurate and systematic accounts and records in respect of the Services, hereunder, in accordance with internationally accepted accounting principles and in such form and detail as will clearly identify all relevant time charges and cost, and the bases thereof (including such bases as may be specifically referred to in the SC) ; (ii) shall permit NHIDCL or its designated representative periodically, and upto one year from the expiration or termination of this Contract, to inspect the same and make copies thereof as well as to have them audited by auditors appointed by NHIDCL; and (iii) shall permit NHIDCL to inspect the Consultant's accounts and records relating to the performance of the Consultant and to have them audited by auditors appointed by NHIDCL.

### **3.7 Consultants' Actions Requiring NHIDCL's Prior Approval**

The Consultants shall obtain NHIDCL's prior approval in writing before taking any of the following actions:

- (a) appointing such members of the Personnel as are listed in Appendix 'C' ("Consultants' Sub-consultants' Key Personnel") merely by title but not by name;
- (b) entering into a subcontract for the performance of any part of the Services, it being understood (i) that the selection of the Sub-Consultant and the terms and conditions of the subcontract shall have been approved in writing by NHIDCL prior to the execution of the subcontract, and (ii) that the Consultants shall remain fully liable for the performance of the Services by the Sub-Consultant and its Personnel pursuant to this Contract; and
- (c) any other action that may be specified in the SC

### **3.8 Reporting Obligations**

The Consultants shall submit to NHIDCL the reports and documents specified in Appendix B here to, in the form, in the numbers and within the time periods set forth in the said Appendix.

### **3.9 Documents Prepared by the Consultants to Be the Property of NHIDCL**

All plans, drawings, specifications, designs, reports, other documents and software prepared by the Consultants for NHIDCL under this Contract shall become and remain the property of NHIDCL, and the Consultants shall, not later than upon termination or expiration of this Contract, deliver all such documents to NHIDCL, together with a detailed inventory thereof. The Consultants may retain a copy of such documents and software. Restrictions about the future use of these documents and software, if any, shall be specified in the SC.

### **3.10 Equipment and Materials Furnished by NHIDCL**

Equipment and materials made available to the Consultants by NHIDCL, or purchased by the Consultants with funds provided by NHIDCL, shall be the property Of NHIDCL and shall be marked accordingly. Upon termination or expiration of this Contract, the Consultants shall make available to NHIDCL an inventory of such equipment and materials and shall dispose of- such equipment and materials in accordance with NHIDCL's instructions. While in possession of such equipment and materials, the Consultants, unless otherwise instructed by NHIDCL in writing, shall insure them at the expense of NHIDCL in an amount equal to their full replacement value.

## **4. Consultants' Personnel and Sub-consultants and or Associates**

### **4.1 General**

The Consultants shall employ and provide such qualified and experienced Personnel and Sub-consultants as are required to carry out the Services.

### **4.2 Description of Personnel**

- (a) The titles, agreed job descriptions, minimum qualification and estimated periods of engagement in the carrying out of the Services of each of the Consultants' Key Personnel are described in Appendix C. If any of the Key Personnel has already been approved by NHIDCLs his/her name is listed as well.
- (b) If required to comply with the provisions of Clause GCC 3.1.1 hereof, adjustments with respect to the estimated periods "of engagement of Key Personnel set forth in Appendix C may be made by the Consultants by written notice to NHIDCL, provided (i) that such adjustments shall not alter the originally estimated period of engagement of any individual by more than 10% or one week, whichever is larger, and (ii) that the aggregate of such adjustments shall not cause payments under this Contract to exceed the ceilings set forth in Clause GC 6.1(b) of this Contract. Any other such adjustments shall only be made with NHIDCL's written approval.

- (c) If additional work is required beyond the scope of the Services specified in Appendix A, the estimated periods of engagement of Key Personnel set forth in Appendix C may be increased by agreement in writing between NHIDCL and the Consultants, provided that any such increase shall not, except as otherwise agreed, cause payments under this Contract to exceed the ceilings set for thin Clause GC 6.1 (b) of this Contract.

#### **4.3 Approval of Personnel**

The Key Personnel i.e. Professional Staff and Sub-consultants listed by title as well as By name in Appendix C are hereby approved by NHIDCL. In respect of other Key Personnel which the Consultants propose, to use in the carrying out of the Services, the Consultants shall submit to NHIDCL for review and approval a copy of their biographical data and (in the case of Key personnel to be used within the country of the Government) a copy of a satisfactory medical certificate in the form attached here to as Appendix D. If NHIDCL does not object in writing(stating the reasons for the objection) within thirty (30) calendar days from the date of receipt of such biographical data and (if applicable) such certificate, such Key Personnel shall be deemed to have been approved by NHIDCL.

#### **4.4 Working Hours, Overtime, Leave, etc.**

- (a) Working hours and holidays for Key Personnel are set forth in Appendix E hereto. To account for travel time, foreign Personnel carrying out Services inside the Government's country shall be deemed to have commenced (or finished) work in respect of the Services such number of days before their arrival in (or after their departure from) the Government's country as is specified in Appendix E hereto.
- (b) The Personnel of all types engaged by Consultant to provide Services on this Contract shall not be entitled to be paid for overtime nor to take paid sick leave or vacation leave **except as specified in Appendix E** hereto, and except as specified. In such Appendix, the Consultants' remuneration shall be deemed to cover these items. All leave to be allowed to the Personnel is included in the staff-months of service set for in **Appendix C**. Any taking of leave by Personnel shall be subject to the prior approval by NHIDCL and the Consultants shall ensure that absence for leave purposes will not delay the progress and adequate supervision of the Services.

#### **4.5 Removal and/or Replacement of Personnel**

Removal and/or replacement of Key Personnel shall be regulated as under:

- 4.5.1** In case notice to commence services pursuant to Clause 2.1 of this Contract is not ordered by NHIDCL within 120 days of signing of contract the key personnel can excuse themselves on valid grounds, e.g., selection on some other assignment, health problem developed after signing of contract, etc. In such a case no penalty shall be levied on the

Firm or on the person concerned. The firm shall however be asked to give a replacement by an equal or better scoring person, whenever mobilization is ordered.

**4.5.2** In case notice to commence services is given within 120 days of signing of contract the, NHIDCL expects all the Key Personnel specified in the Proposal to be available during implementation of the Agreement. NHIDCL will not consider any substitution of Key Personnel except under compelling circumstances beyond the control of the Consultant and the concerned Key Personnel. Such substitution shall be limited to not more than three Key Personnel subject to equally or better qualified and experienced personnel being provided to the satisfaction of NHIDCL. Replacement of the Team Leader will not normally be considered and may lead to disqualification of the Applicant or termination of the Agreement. Replacement of one Key Personnel shall be permitted subject to reduction of remuneration equal to 5 % (five per cent) of the total remuneration specified for the Key Personnel who is proposed to be replaced. In case of second replacement the reduction in remuneration shall be equal to 10% (ten per cent) and for third and subsequent replacement, such reduction shall be equal to 15% (fifteen per cent) If the consultant finds that any of the personnel had made false representation regarding his qualification and experience, he may request the NHIDCL for replacement of the personnel. There shall be no reduction in remuneration for such replacement. The replacement shall however be of equal or better score. The personnel so replaced shall be debarred from future projects for 2 years.

**4.5.4** Replacement after original contract period is over:

There shall be no limit on the replacements and no reduction in remunerations shall be made. The replacement shall however be of equal or better score.

**4.5.5** If the NHIDCL (i) finds that any of the Personnel has committed serious misconduct or has been charged with having committed a criminal action or (ii) has reasonable ground to be dissatisfied with the performance of any of the Personnel, then the consultant shall, at the NHIDCL's written request specifying the grounds therefore, forthwith provide a replacement with qualifications and experience acceptable to him. For such replacement there will be no reduction in remuneration.

**4.5.6** If any member of the approved team of a consultant engaged by NHIDCL leaves that consultant before completion of the job, he shall be barred for a period of 6 months to 24 months from being engaged as a team member of any other consultant working (or to be appointed) for any other NHIDCL / MoRTH projects.

**4.5.7** In order to minimize the delay in approval of replacements, Consultant shall submit the proposal directly to the competent level responsible for such approvals. The approval for replacement of key personnel shall be accorded within one month of submission of such proposal. In case of further delay, unless refused after due evaluation of CV by the Authority within a month, it will be considered deemed approval of such replacements proposed.

**4.5.8** In case, person permanently employed with the firm is to be replaced, Technical score of both the CVs shall be compared excluding the marks given for employment with firm. Replacement would be allowed when the Technical Score (excluding the marks given for employment with firm) of the new key person is equal or better than the existing key person's Technical Score excluding marks assigned for permanent employment with the firm. However, the remuneration of such replacement shall be reduced on proportionate basis in case the overall score of the replacement person is less than the overall score of original person.

#### **4.6 Resident Team Leader and Coordinator**

The person designated as the Team Leader of the Consultant's Personnel shall be responsible for the coordinated, timely and efficient functioning of the Personnel. In addition, the Consultant shall designate a suitable person from its Head Office as Project Coordinator who shall be responsible for day to day performance of the Services.

### **5. Obligations of NHIDCL**

#### **5.1 Assistance and Exemptions**

Unless otherwise specified in the SC, NHIDCL shall use its best efforts to ensure that the Government shall:

- (c) provide the Consultants, Sub-consultants and Personnel with work permits and such other documents as shall be necessary to enable the Consultants, Sub-consultants or Personnel to perform the Services;
- (d) assist for the Personnel and, if appropriate, their eligible dependents to be provided promptly with all necessary entry and exit visas, residence permits, exchange permits and any other documents required for their stay in Government's country;
- (e) Facilitate prompt clearance through customs of any property required for the Services and of the personal effects of the Personnel and their -eligible dependents;
- (f) Issue to officials, agents and representatives of the Government all such instructions as may be necessary or appropriate for the prompt and effective implementation of the Services;
- (g) assist the Consultants and the Personnel and any Sub-consultants and or Associates employed by the Consultants for the Services from any requirement to register or obtain any permit to practice their profession or to establish themselves either individually or as a corporate entity according to the Applicable Law;
- (h) grant to the Consultants, any Sub-consultants and or Associates and the Personnel of either of them the privilege, pursuant to the Applicable Law, of bringing into Government's country reasonable amounts of foreign currency

for the purposes of the Services or for the personal use of the Personnel and their dependents and of withdrawing any such amounts as may be earned therein by the Personnel in the execution of the Services: and

- (i) Provide to the Consultants, Sub-consultants and or Associates and Personnel any such other assistance as may be specified in the SC.

## **5.2 Access to Land**

NHIDCL warrants that the Consultants shall have, free of charge, unimpeded access to all land in the Government's country in respect of which access is required for the performance of the Services. NHIDCL will be responsible for any damage to such land or any property thereon resulting from such access and will indemnify the Consultants and each of the Personnel in respect of liability for any such damage, unless such damage is caused by the default or negligence of the Consultants or any Sub-Consultant or the Personnel of either of them.

## **5.3 Change in the Applicable Law**

If, after the date of this Contract, there is any change in the Applicable Law with respect to taxes and duties which increases or decreases the cost or reimbursable expenses incurred by the Consultants in performing the Services, then the remuneration and reimbursable expenses otherwise payable to the Consultants under this Contract shall be increased or decreased accordingly by agreement between the Parties hereto, and corresponding adjustments shall be made to the ceiling amounts specified in Clause GC 6.1(b).

## **5.4 Services, Facilities and Property of NHIDCL**

NHIDCL shall make available to the Consultants and the Personnel, for the purposes of the services and free of any charge, the services, facilities and property described in Appendix F at the times and in the manner specified in said Appendix F, provided that if such services, facilities and property shall not be made available to the Consultants as and when so specified, the Parties shall agree on (i) any time extension that it may be appropriate to grant to the Consultants for the performance of the Services, (ii) the manner in which the Consultants shall procure any such services, facilities and property from other sources, and (iii) the additional payments, if any, to be made to the Consultants as a result thereof pursuant to Clause GC 6.1(c) hereinafter.

## **5.5 Payment**

In consideration of the Services performed by the Consultants under this Contract, NHIDCL shall make to the Consultants such payments and in such manner as is provided by Clause GC 6 of this Contract.

## **5.6 Counterpart Personnel**

- (a) If so provided in Appendix F hereto, NHIDCL shall make available to the

Consultants, as and when provided in such Appendix F, and free of charge, such counterpart personnel to be selected by NHIDCL, with the Consultants' advice, as shall be specified in such **Appendix F**. Counterpart personnel shall work under the exclusive direction of the Consultants. If any member of the counterpart personnel fails to perform adequately any work assigned to him by the Consultants which is consistent with the position occupied by such member, the Consultants may request the replacement of such member, and NHIDCL shall not unreasonably refuse to act upon such request.

- (b) If counterpart personnel are not provided by NHIDCL to the Consultants as and when specified in Appendix F, NHIDCL and the Consultants shall agree on
  - (i) how the affected part of the Services shall be carried out, and (ii) the additional payments, if any, to be made by NHIDCL to the Consultants as a result thereof pursuant to Clause GC 6.1(c) hereof.

## **6. Payments to the Consultants**

### **6.1 Cost Estimates; Ceiling Amount**

- (a) An estimate of the cost of the Services payable is set forth in Appendix G.
- (b) Except as may be otherwise agreed under Clause GC2.6 and subject to Clause GC 6.1(c), payments under this Contract shall not exceed the ceilings specified in the SC. The Consultants shall notify NHIDCL as soon as cumulative charges incurred for the Services have reached 80% of these ceilings.
- (c) Notwithstanding Clause GC6.1 (b) hereof, if pursuant to clauses GC5.3, 5.4 or 5.6 hereof, the Parties shall agree that additional payments shall be made to the Consultants in order to cover any necessary additional expenditures not envisaged in the cost estimates referred to in Clause GC6.1(a) above, the ceiling or ceilings, as the case maybe, set forth in Clause GC6.1(b) above shall be increased by the amount or amounts, as the case may be, of any such additional payments.

### **6.2 Remuneration and Reimbursable Expenditures**

- (a) Subject to the ceilings specified in Clause GC6.1(b) hereof, NHIDCL shall pay to the Consultants (i) remuneration asset for thin Clause GC6.2(b), and (ii) reimbursable expenditures asset forth in Clause GC6.2(c). If specified in the SC, said remuneration shall be subject to price adjustment as specified in the SC.
- (b) Remuneration for the Personnel shall be determined on the basis of time actually spent by such Personnel in the performance of the Services after the date determined in accordance with Clause GC2.3 and Clause SC2.3 (or such other date as the Parties shall agree in writing) (including time for necessary travel via the most direct route) at the rates referred to, and subject to such additional provisions as are set forth, in the SC.
- (c) Reimbursable expenditures actually and reasonably incurred by the Consultants in the performance of the Services, as specified in SC.

- (d) Notwithstanding anything to the contrary stated in the GCC and SCC, it shall be mandatory to deploy the key personnel and sub-professional as per the Man-Months Input specified in the Terms of Reference.

Inadequate deployment of key personnel and sub-professional shall lead to deduction in the monthly payment as per following table. The key personnel and sub-professional shall be considered to be inadequately deployed if he/she is not present for atleast 90% of the time stipulated in the month, as per the Man Months Input in the Terms of Reference and the Deployment Schedule proposed by the firm.

Sr. No.	Personnel	% reduction in monthly payment
<b>Normal Highway Project</b>		
1	Team Leader cum Senior Highway Engineer	20%
2	Resident Engineer cum Highway Engineer	25%
3	Bridge/Structural Engineer	20%
4	Other Key Personnel	20%
5	Sub- Professional Staff	15%

For avoidance of doubt, in case the Team Leader cum Senior Highway Engineer has not been made available for 90% of the stipulated time in the month, then only 80% of the monthly payment shall be released. In the case of "Other Key Personnel (Sr. No. 4)" and "Sub – Professional Staff (Sr. No. 5)", the average availability across the group shall be considered for calculation.

### **6.3 Currency of Payment**

All payments shall be made in Indian Rupees and shall be subjected to applicable Indian laws withholding taxes if any.

### **6.4 Mode of Billing and Payment**

Billing and payments in respect of the Services shall be made as follows:

- (a) NHIDCL shall cause to be paid to the Consultants an interest bearing advance payment as specified in the SC, and as otherwise set forth below. The advance payment will be due after provision by the Consultants to NHIDCL of a bank guarantee by a bank acceptable to NHIDCL in an amount (or amounts) and in a currency (or currencies) specified in the SC, such bank guarantee (i) to remain effective until the advance payment has been fully set off as provided in the SC, and(ii)to be in the form set for thin Appendix I hereto or in such other form as NHIDCL shall have approved in writing.
- (b) As soon as practicable and not later than fifteen (15days)after the end of each calendar month during the period of the Services, the Consultants shall submit to NHIDCL, in duplicate, itemized statements, accompanied by copies of receipted invoices, vouchers and other appropriate supporting materials, of the

amounts payable pursuant to Clauses GC6.3 and 6.4 for such month. Each monthly statement shall distinguish that portion of the total eligible costs which pertains to remuneration from that portion which pertains to reimbursable expenditures.

- (c) 75% of bill raised by the Consultant shall be paid within 72 Hrs and remaining bill may be paid after due scrutiny. NHIDCL shall cause the payment of the Consultants periodically as given in schedule of payment above within thirty (30) days after the receipt by NHIDCL of bills with supporting documents. Only such portion of a monthly statement that is not satisfactorily supported may be withheld from payment. Should any discrepancy be found to exist between actual payment and costs authorized to be incurred by the Consultants, NHIDCL may add or subtract the difference from any subsequent payments. Interest at the rate specified in the SC shall become payable as from the above due date on any amount due by, but not paid on such due date.
- (d) The final payment under this Clause shall be made only after the final report and a final statement, identified as such, shall have been submitted by the Consultants and approved as satisfactory by NHIDCL. The Services shall be deemed completed and finally accepted by NHIDCL and the final report and final statement shall be deemed approved by NHIDCL as satisfactory ninety (90) calendar days after receipt of the final report and final statement by NHIDCL unless NHIDCL, within such ninety (90)-day period, gives written notice to the Consultants specifying in detail deficiencies in the Services, the final report or final statement. The Consultants shall there upon promptly make any necessary corrections, and upon completion of such corrections, the foregoing process shall be repeated. Any amount which NHIDCL has paid or caused to be paid in accordance with this Clause in excess of the amounts actually payable in accordance with the provisions of this Contract shall be reimbursed by the Consultants to NHIDCL within thirty, (30) days after receipt by the Consultants of notice thereof. Any such claim by NHIDCL for reimbursement must be made within twelve (12) calendar months after receipt by NHIDCL of a final report and a final statement approved by NHIDCL in accordance with the above.
- (e) All payments under this Contract shall be made to the account of the Consultants specified in the SC.

## **7. Fairness and Good Faith**

### **7.1 Good Faith**

The Parties undertake to act in good faith with respect to each other's rights under this Contract and to adopt all reasonable measures to ensure the realization of the objectives of this Contract.

### **7.2 Operation of the Contract**

The Parties recognize that it is impractical in this Contract to provide for every contingency which may arise during the life of the Contract, and the Parties hereby agree that it is their intention that this Contract shall operate fairly as between them, and without detriment to the interest of either of them, and that, if during the term of this Contract either Party believes that this Contract is operating unfairly, the Parties will use their best efforts to agree on such action as may be necessary to remove the cause or causes of such unfairness, but no failure to agree on any action pursuant to this Clause shall give rise to a dispute subject to arbitration in accordance with Clause GC 8 hereof.

## **8. Settlement of Disputes**

### **8.1 Amicable Settlement**

The Parties shall use their best efforts to settle amicably all disputes arising out of or in connection with this Contract the interpretation thereof.

### **8.2 Dispute Resolution**

8.2.1 Any dispute, difference or controversy of whatever nature howsoever arising under or out of or in relation to this Agreement (including its interpretation) between the Parties, and so notified in writing by either Party to the other Party (the “**Dispute**”) shall, in the first instance, be attempted to be resolved amicably in accordance with the conciliation procedure set forth in Clause 8.3.

8.2.2 The Parties agree to use their best efforts for resolving all Disputes arising under or in respect of this Agreement promptly, equitably and in good faith, and further agree to provide each other with reasonable access during normal business hours to all non – privileged records, information and data pertaining to any dispute.

### **8.3 Conciliation**

In the event of any Dispute between the Parties, either Party may call upon [Managing Director of NHIDCL] and the Chairman of the Board of Directors of the Consultant or a substitute thereof for amicable settlement, and upon such reference, the said persons shall meet no later than 10(ten) days from the date of reference to discuss and attempt to amicably resolve the Dispute. If such meeting does not take place within the 10(ten) day period or the Dispute is not amicably settled within 15(fifteen) days of the meeting or the Dispute is not resolved as evidenced by the signing of written terms of settlement within 30 (thirty) days of the notice in writing referred to in Clause 8.2.1 or such longer period as may be mutually agreed by the Parties, either Party may refer the Dispute to arbitration in accordance with the Provisions of Clause 8.4.

### **8.4 Arbitration**

8.4.1. Any Dispute which is not resolved amicably by conciliation, as provided in Clause 8.3, shall be finally decided by reference to arbitration by an Arbitral Tribunal appointed in

accordance with Clause 8.4.2. Such arbitration shall be held in accordance with the Rules of Arbitration of the International Centre for Alternative Dispute Resolution, New Delhi (the "Rules"), or such other rules as may be mutually agreed by the Parties, and shall be subject to the provisions of the Arbitration and Conciliation Act, 1996 as amended. The venue of such arbitration shall be \*\*\*\*\* and the language of arbitration proceedings shall be English.

**8.4.2** Each dispute submitted by a Party to arbitration shall be heard by a sole arbitrator to be appointed as per the procedure below

(a) Parties may agree to appoint a sole arbitrator or, failing agreement on the identity of such sole arbitrator within thirty(30) days after receipt by the other Party of the proposal of a name for such an appointment by the Party who initiated the proceedings, either Party may apply to the President, Indian Roads Congress, New Delhi for a list of not fewer than five nominees and, on receipt of such list, the Parties shall alternately strike names there from, and the last remaining nominee on the list shall be sole arbitrator for the matter in dispute. If the last remaining nominee has not been determined in this manner within sixty (60) days of the date of the list, the President, Indian Roads Congress, New Delhi, shall appoint, upon the request of either Party and from such list or otherwise, a sole arbitrator for the matter in dispute.

**8.4.3 Substitute Arbitrator**

If for any reason an arbitrator is unable to perform his function, a substitute shall be appointed in the same manner as the original arbitrator.

**8.4.4 Qualifications of Arbitrator**

The sole arbitrator selected pursuant to Clause 8.2.1 hereof shall be expert with extensive experience in relation to the matter in dispute.

**8.4.5** The Arbitrators shall make a reasoned award (the "Award"). Any Award made in any arbitration held pursuant to this Clause 8 shall be final and binding on the Parties as from the date it is made, and the Consultant and NHIDCL agree and undertake to carry out such Award without delay.

**8.4.6** The Consultant and NHIDCL agree that an Award may be enforced against the Consultant and/or NHIDCL, as the case may be, and their respective assets wherever situated.

**8.4.7.** This Agreement and the rights and obligations of the Parties shall remain in full force and effect, pending the Award in any arbitration proceedings hereunder

**8.4.8 Miscellaneous**

In any arbitration proceeding hereunder:

- (a) Proceedings shall, unless otherwise agreed by the parties shall be held in Delhi.
- (b) The English language shall be the official language for all purposes;
- (c) The decision of sole arbitrator shall be final and binding and shall be enforceable in any court of competent jurisdiction, and the Parties hereby waive any objections to or claims of immunity in respect of such enforcement; and
- (d) The schedule of Expenses and Fee payable to the Arbitrator shall be as under

Sr. No.	Particulars of Fees and Expenses	Maximum amount payable per case
1	Fee	(i) Rs. 25,000/- per day; (ii) 25% extra on fee at (i) above in case of fast-track procedure as per Section -29 (B) of A&C Act; Or 10% extra on fee at (i) above if award is published within 6 months from date of entering the reference by AT; Alternatively, the Arbitrator may opt for a lump-sum fee of Rs. 5.00 Lakh per case including counter-claims.
2	Reading charges- one Time	Rs 25,000/- per case including counter claims.
3	One-time charges for Secretarial Assistance and Incidental Charges (telephone, fax, postage etc.)	Rs. 25,000/- per case
4	One time charges for publishing/declaration of the Award	Rs. 40,000/-
5	Other expenses (As per actual against bills subject to celling given below	
(i)	Travelling expenses	Economy class (by air), First class AC (by train) and AC Car (by road)
(ii)	Lodging and Boarding	Rs. 15,000/- per day (in metro cities); or Rs. 8000 per day (in other cities); or Rs. 5,000/- per day, if any Arbitrator makes their own arrangements.
6.	Local travel	Rs. 2,000 /- per day
7	Extra charges for days other than meeting days (maximum for 2 X ½ days)	Rs. 5000 /- per ½ day for outstation Arbitrator
Note	1. Lodging boarding and travelling expenses shall be allowed only for the arbitrator who is are residing 100 kms. away from the venue of meeting,	
	2. Delhi, Mumbai, Chennai, Kolkata, Bengaluru and Hyderabad shall be considered as Metro cities.	

In exceptional cases, such as cases involving major legal implications/wider ramifications/higher financial stakes etc. a special fee structure could be fixed in consultation with the Contractor/Supervision Consultants and with the specific approval of the <Agency> before appointment of the Arbitrator

**9. Fake CV**

If any case of fake/incorrect/inflated CV is found, it shall be dealt with very severely and would result in all possible penal action including blacklisting from future projects of NHIDCL. This would also apply even when the consulting firm is not successful in getting the assignment. In case , the information contained in the CV for the duration in which the key personnel was not employed by the firm proposing his candidature is found incorrect/Fake/inflated at any stage , the consultancy firms will have to refund the twice of salary and perks drawn in respect of the person.

## II. SPECIAL CONDITIONS OF CONTRACT

### GC Clause

#### A. **Amendments of, and Supplements to, Clauses in the General Conditions of Contract**

1.1(a) The words " in the Government's country" are amended to read "in INDIA"

1.4 The language is: English

1.6.1 The addresses are:

**NHIDCL: Address of NHIDCL Attention:**

**Telephone:**

**E-mail :**

**Consultant: Address of Consultant Attention:**

**Postal address:**

**Telephone:**

**E-Mail:**

***[Note' : Fill in the Blanks]***

1.6.2 Notice will be deemed to be effective as follows:

- (a) in the case of personal delivery or registered mail, on delivery;
- (b) in the case of Telephone, 24 hours following confirmed transmission;
- (c) in the case of Email, 24 hours following confirmed transmission; and
- (d) in the case of facsimiles, 24 hours following confirmed transmission.

1.8 The Executive Director in Charge is: ED (P) Sh. \_\_\_\_\_

*(Note: If the Consultants consist of a joint venture of more than one entity, the name of the entity whose address is specified in SC1.6.1 should be inserted here. If the Consultants consist of one entity, this Clause 1.8 should be deleted from the SC)*

1.9 The Authorized Representative are:

For NHIDCL: [.....]

For the Consultants: [.....]

1.10 The Consultants, Sub-consultants and the Personnel shall pay the taxes, duties, fees, levies and other impositions levied under the existing, amended or enacted laws during life of this contract and NHIDCL shall perform such duties in regard to the deduction of such tax as may be lawfully imposed.

2.1 The effectiveness conditions are the following:

i) Approval of the Contract by NHIDCL

2.2 The time period shall be [4 month] or such other time period as the parties may agree in writing.

2.3 The time period shall be [one] month or such other time period as the Parties may agree in writing.

2.4 The time period shall be [84] months (24) month for construction period and [60] months for Maintenance period)

### 3.4 Limitation of the Consultants' Liability towards NHIDCL

(a) Except in case of gross negligence or willful misconduct on the part of the Consultants or on the part of any person or firm acting on behalf of the Consultants in carrying out the Services, the Consultants, with respect to damage caused by the Consultants to NHIDCL's property, shall not be liable to NHIDCL:

(i) for any indirect or consequential loss or damage; and

(ii) Consultant will maintain at its expenses; Professional Liability Insurance including coverage for errors and omissions caused by Consultant's negligence in the performance of its duties under this agreement,(A)For the amount not exceeding total payments for Professional Fees and Reimbursable Expenditures made or expected to be made to the Consultants hereunder OR

(B) the proceeds, the Consultants may be entitled to receive from any insurance maintained by the Consultants to cover such a liability, whichever of (A) or (B) is higher.

(iii) The policy should be issued only from an Insurance Company operating in India.

(iv) The policy must clearly indicate the limit of indemnity in terms of "Any One Accident"(AOA) and "Aggregate limit on the policy period"(AOP)

and in no case should be for an amount less than stated in the contract.

- (v) If the Consultant enters into an agreement with NHIDCL in a joint venture or 'in association', the policy must be procured and provided to NHIDCL by the joint venture/in association entity and not by the individual partners of the joint venture/association.
- (vi) The contract may include a provision whereby the Consultant does not cancel the policy midterm without the consent of the NHIDCL. The insurance company may provide an undertaking in this regard.
- (b) This limitation of liability shall not affect the Consultants' liability, if any, for damage to Third Parties caused by the Consultants or any person or firm acting on behalf of the Consultants in carrying out the Services.
- (c) Professional Liability Insurance may be accepted for initially one year which shall be extended annually for five years. PLI shall be uniformly taken for a period of five years.

### **3.5 The risks and the coverage shall be as follows**

- (a) Third Party motor vehicle liability insurance as required under Motor Vehicles Act,1988 in respect of motor vehicles operated in India by the Consultants or their Personnel or any Sub-consultants or their Personnel for the period of consultancy.
- (b) Third Party liability insurance with a minimum coverage, of Rs. 1.0 million for the period of consultancy.
- (c) Professional liability insurance (PLI) as per 3.4 (a) (ii) of SC of the consultancy, with a minimum coverage equal to estimated remuneration and reimbursable.
- (d) NHIDCL's liability and workers' compensation insurance in respect of the Personnel of the Consultants and of any Sub-consultant, in accordance with the relevant provisions of the Applicable Law, as well as, with respect to such Personnel, any such life, health, accident, travel or other insurance as may be appropriate; and
- (e) Insurance against loss of or damage to(i) equipment purchased in whole or in part with funds provided under this Contract, (ii) the Consultants' property used in the performance of the Services, and(iii)any documents prepared by the Consultants in the performance of the Services.

#### **3.7(c) The other actions are**

"(i) taking any action under a civil works contract designating the Consultants as "Authority's Engineer", for which action, pursuant to such civil works contract, the written approval of NHIDCL is required".

#### **3.9 The Consultants shall not use these documents for purposes unrelated to this**

Contract without the prior written approval of NHIDCL.

4.6 "The person designated as Team Leader cum Senior Highway Engineer in Appendix C shall serve in that capacity, as specified in Clause GC 4.6."

6.1(b) **The amount payable Indian Rupee is : [.....] (in Numeric & Words)**

6.2(a) "Payments for remuneration and reimbursable items made in accordance with Clause GC 6:2(a) :

- (i) Consultants shall be paid billing rates for services rendered by the personnel of all categories namely (i) key Personnel; (ii) sub-Professional personnel and (iii) Support staff on man-month basis . Billing rates of remaining items of the financial proposal, namely (i) transportation , (ii) Duty travel to site (iii) Office Rent, (iv) office supplies communication etc. (v) reports & document printing and (vi) survey equipment etc. shall be worked out month wise as per actual expenditure Beginning 13<sup>th</sup> months from the last date of submission of bid, billing rates shall be increased to cover all items of contract i.e. remuneration, vehicle hire, office rent, consumables, furniture etc. @ 5% every 12 months. However, for evaluation and award of the Bid proposals, the quoted initial rate (as applicable for first 12 months from last date of submission of bid) shall be multiplied by the total time input for each position on this contract, i.e. without considering the increase in the billing rates. All payments shall be made in Indian Rupees and shall be subjected to applicable Indian laws withholding taxes if any.
- (ii) Remuneration paid pursuant to the rates set forth in Appendix G shall be adjusted every twelve (12) months (and, the first time, with effect for the billing rates earned in the 13<sup>th</sup>calendar month after the last date of submission of bid) by 5% every 12month for personnel.

Notwithstanding any other provisions in the agreement in this regard, this provision will prevail and override any other provision to the contrary in this agreement.

- 6.2(b) (i) (1) Payment of Authority Engineer shall be released on approval of the monthly reports. Report shall be approved by NHIDCL only if it includes all the sections prescribed in the format and submitted as per specified timelines.
- (2) Payment shall be released as per rates quoted in Appendix C3- Breakup of Local currency costs
- (3) For equipment based road inspection to be conducted in O&M phase, payment shall be released as per actual use of equipment on road and rates quoted in Appendix C3- Breakup of Local currency costs.

- (4) If any of the report is found to be misleading or containing incorrect information as determined by NHIDCL, 10% of payment linked to that report shall be deducted as penalty
- (5) It is understood(i)that the remuneration rates shall cover(A) such salaries and allowances as the Consultants shall have agreed to pay to the Personnel as well as factors for social charges and overhead, and (B)the cost of back stopping by home office staff not included in the Personnel listed in Appendix C, and(C)the Consultants' fee;(ii)that bonuses or other means of profit-sharing shall not be allowed as an element of overhead, and(iii)that any rates specified for persons not yet appointed shall be provisional and shall be subject to revision, with the written approval of NHIDCL, once the applicable salaries and allowances are known.
- (6) Remuneration for periods of less than one month shall be calculated on an hourly basis for actual time spent in the Consultants' home office and directly attributable to the Services(one hour being equivalent to 1/240th of a month) and on a calendar-day basis for time spent away from home office(one day being equivalent to 1/30th of a month).

6.2(b)(ii) The rates for foreign and local Personnel are set forth in Appendix G 6.4(a) The following provisions shall apply to the interest bearing advance payment and the advance payment guarantee:

- 1) An advance payment of 10% of the contract price in proportion to the quoted Indian currency (INR) in the bid shall be made within 60 days after receipt and verification of advance payment bank guarantee. The advance payment along with interest will be set off by NHIDCL in equal installments against the statements for the first 12 months of the Service until the advance payment has been fully set off. The advance payment shall be in Indian Rupee.
- 2) The bank guarantee shall be in the amount and in the currency of the the advance payment.
- 3) Interest rate shall be 10% per annum (on outstanding amount).

6.4(c) The interest rate is 10% per annum. 6.4(e) The accounts are:

[Note: Insert account number, type of account and name and address of the Bank]

8.2 Disputes shall be settled by arbitration in accordance with the following provisions:

## **9. PENALTY**

- (i) If the Authority's Engineer does not approve the design and drawing within a period of 15 days from the submission by the contractor, a penalty of Rs. 5000/- per day shall be levied on the contractor.

However, if the design and drawing needs to be reviewed by any third party, exception from NHIDCL shall be sought by the AE for prevention from imposition of such penalty.

(ii) If the Authority's Engineer fails to submit a satisfactory Project Quality Audit and the Project Safety Audit report as stipulated in Para 15 of the TOR, in that case a fine of Rs. 1 lakh shall be imposed on the Authority's Engineer.

#### **IV. APPENDICES**

##### **Appendix A: Description of the Services**

*[Give detailed descriptions of the Services to be provided; dates for completion of various tasks, place of performance for different tasks; specific tasks to be approved by NHIDCL, etc.]*

**Details as per TOR**

## Appendix B: Reporting Requirements

*[List format, frequency, contents of reports and number of copies; persons to receive them; dates of submission etc. If no reports are to be submitted, state here "Not applicable".]*

**Please refer TOR**

## **Appendix C: Key Personnel and Sub-consultants**

- [List under: C-1      Titles [and names, if already available], detailed job descriptions and minimum qualifications. Experience of Personnel to be assigned to work in India, and staff- months for each.*
- C-2      Same information as C-1 for Key local Personnel.*
- C-3      Same as C-1 for Key foreign Personnel to be assigned to work outside India.*
- C-4      List of approved Sub-consultants [if already available]; same information with respect to their Personnel as in C-1 through C-4)*

**Please refer TOR**

## **Appendix D: Medical Certificate**

*[Show here an acceptable form of medical certificate for foreign Personnel to be stationed in India. If there is no need for a medical certificate, state here: "Not applicable. "]*

**The form of Medical Certificate as required under the rules of Govt. of India**

## **Appendix E: Hours of Work for Key Personnel**

The Consultants Key personnel and all other Professional / Sub Professional / Support Staff/Sub-Consultancy personnel shall work 6 days (Mondays through Saturday) every week and observe the Gazetted Holidays of Government of India as Holidays. The Consultant shall work as per the work program of the EPC Contractor. In this context in case the work plan of the Consultant needs suitable modifications, the same shall be carried out and submitted to NHIDCL for consideration. The Consultants hours of work normally shall match with that of Contractor's activities on the site. No extra remuneration shall be claimed or paid for extra hours of work required in the interest of Project completion.

In respect of foreign personnel, one day per trip as travel time from and to India shall be allowed.

**Appendix F: Duties of NHIDCL**

[List here under:

F-1 Services, facilities and property to be made available to the Consultants by NHIDCL.

F-2 Counterpart personnel to be made available to the Consultants by NHIDCL.]

**Please refer TOR**

## Appendix G: Cost Estimates

List hereunder cost estimate in INR:

1. Monthly rates for local Personnel (Key Personnel and other Personnel)
2. Reimbursable/Rental/Fixed expenditures as follows:
  - a. Cost of local transportation.
  - b. Cost of other local services, rentals, utilities, etc.

**Appendix H: FORM OF PERFORMANCE SECURITY**

**(PERFORMANCE BANK GUARANTEE)**

(Clause-13 of TOR)

**To**

**Address of NHIDCL:**

WHEREAS [**Name and address of Consultants**] <sup>1</sup> (hereinafter called "the consultants") has undertaken, in pursuance of Contract No.[...] dated [DD/MM/YYYY] to provides the services on terms and conditions set forth in this Contract [Name of contract and brief description of works) (hereinafter called the "the Contract").

AND WHEREAS it has been stipulated by you in the said Contract that the Consultants shall furnish you with a Bank Guarantee by a recognized bank for the sum specified there in as security for compliance with his obligations in accordance with the Contract;

AND WHEREAS we have agreed to give the Consultants such a BankGuarantee;

NOW THEREOF we hereby affirm that we are the Guarantor and responsible to you, on behalf of the Consultants up to a total of [amount of Guarantee in numeric]<sup>2</sup> [Amount in words], such sum being payable in the types and proportions of currencies in which the Contract Price is payable, and we undertake to pay you, upon your first written demand and without cavil or argument, any sum or sums within the limits of [amount of Guarantee] as aforesaid without your needing to prove or to show grounds or reasons for your demand for the sum specified therein.

We hereby waive the necessity of your demanding the said debt from the Consultants before presenting us with the demand.

We further agree that no change or addition to or other modification of the terms of the Contract or of the services to be performed there under or of any of the Contract documents which may be made between you and the Consultants shall in any way release us from any liability under this guarantee, and we hereby waive notice of any such change, addition or modification.

The liability of the Bank under this Guarantee shall not be affected by any change in the constitution of the consultants or of the Bank.

Notwithstanding anything contained herein before, our liability under this guarantee is restricted to Rs.[Amount in Numeric](Rs. Amount in words)) and the guarantee shall remain valid till [DD/MM/YYYY]. Unless a claim or a demand in writing is made up on us on or before [DD/MM/YYYY]all our liability underthis guarantee shall cease.

This guarantee shall be valid for a period of [...] months i.e. up to 2 months beyond the expiry of contract of [...] months.

Bank Guarantee has been sent to authority's bank through SFMS gateway as per the details below: -

<b>Particulars</b>	<b>Details</b>
<b>Name of the Beneficiary</b>	National Highways and Infrastructure Development Corporation Limited
<b>Beneficiary Bank Account No.</b>	90621010002659
<b>Beneficiary Bank Branch</b>	IFSC CNRB0019062
<b>Beneficiary Bank Branch Name</b>	Transport Bhawan, New Delhi
<b>Beneficiary Bank Address</b>	Syndicate Bank, Transport Bhawan, 1st Parliament street, New Delhi-110001

<b>Signature and Seal of the Guarantor [.....]</b>
<b>In presence of</b>
<b>Name &amp; Designation</b>
1
<b>Name , Signature &amp; Occupation</b>
<b>Name of the bank</b>
<b>Address</b>
<b>Date</b>
2
<b>Name , Signature &amp; Occupation</b>
<b>Name of the bank</b>
<b>Address</b>
<b>Date</b>

**NOTES:**

<sup>1</sup> Give names of all partners if the Consultants is a Joint Venture.

## Appendix I: Form of Bank Guarantee for Advance Payments (Reference Clause 6.4(a) of Contract)

(To be stamped in accordance with Stamp Act, if any, of the country of issuing bank)

Ref: Bank Guarantee: [BG No.]

Date [DD/MM/YYYY]

**Dear Sir,**

In consideration of National Highways & Infrastructure Development Corporation Limited (herein after referred as the "Client", which expression shall, unless repugnant to the context or meaning there of include it successors, administrators and assigns) having awarded to M/s **[Name of the consultant]** (herein after referred to as the "Consultant" which expression shall unless repugnant to the context or meaning thereof, include its successors, administrators, executors and assigns), a contract by issue of client's Contract Agreement No.[....]dated[DD/MM/YYYY] and the same having been unequivocally accepted by the Consultant, resulting in a Contract valued at[.....]

For Contract (hereinafter called the "Contract") (scope of work) and NHIDCL having agreed to make an advance payment to the Consultant for performance of the above Contract amounting to (in words and figures) as an advance against Bank Guarantee to be furnished by the Consultant.

We **[Name of the Bank]** having its Head Office at [Address](herein after referred to as the Bank), which expressions shall, unless repugnant to the context or meaning thereof, include its successors, administrators executors and assigns) do hereby guarantee and undertake to pay NHIDCL immediately on demand any or, all monies payable by the Consultant to the extent of[.....] as aforesaid at any time up to [.....] @[.....] without any demur, reservation, contest, recourse or protest and/or without any reference to the consultant. Any such demand made by NHIDCL on the Bank shall be conclusive and binding notwithstanding any difference between NHIDCL and the Consultant or any dispute pending before any Court, Tribunal, Arbitrator or any other authority. We agree that the Guarantee herein contained shall be irrevocable and shall continue to be enforceable till NHIDCL discharges this guarantee.

NHIDCL shall have the fullest liberty without affecting in any way the liability of the Bank under this Guarantee, from time to time to vary the advance or to extend the time for performance of the contract by the Consultant. NHIDCL shall have the fullest liberty without affecting this guarantee, to postpone from time to time the exercise of any powers vested in them or of any right which they might have against NHIDCL and to exercise the same at any time in any manner, and either to enforce or to forebear to enforce any covenants, contained or implied, in the Contract between NHIDCL and the Consultant other course or remedy or security available to NHIDCL. The bank shall not be relieved of its obligations under these presents by any exercise by NHIDCL of its liberty with reference to the matters aforesaid or any of them or by reason of any other act or forbearance or other acts of omission or commission on the part of NHIDCL or any other Indulgence shown by NHIDCL or by any other matter or thing whatsoever which under law would but for this provision have the effect of relieving the Bank.

The Bank also agrees that NHIDCL at its option shall be entitled to enforce this Guarantee against the Bank as a principal debtor, in the first instance without proceeding against the Consultant and

notwithstanding any security or other guarantee that NHIDCL may have in relation to the Consultant's liabilities.

Notwithstanding anything contained herein above, our liability under this guarantee is limited to [.....] and it shall remain in force up to and including [DD/MM/YYYY] and shall be extended from time to time for such period (not exceeding one year), as may be desired by M/s [Name of the Consultant] on whose behalf this guarantee has been given.

This guarantee shall also be operable at our [Branch Name & Address] New Delhi office, from whom, confirmation regarding the issue of this guarantee or extension / renewal thereof shall be made available on demand. In the contingency of this guarantee being invoked and payment there under claimed, the said branch shall accept such invocation letter and make payment of amounts so demanded under the said invocation.

The liability of bank under this Guarantee shall not be affected by any change in the constitution of the consultant or of the Bank.

Dated this [DD] day of [Month], 2021 at [Place]

<b>WITNESS</b>	
[Signature] <b>[Name of the Witness]</b>	
Signature <b>[Name of the Officer 1]</b> Designation (With Bank Stamp)	
Signature <b>[Name of the Officer 2]</b> Designation (With Bank Stamp)	
<b>[Official Address]</b>	
	Attorney as per Power of Attorney No: [.....]  <b>Dated: [DD/MM/YYYY]</b>

**NOTES: (Not to be included in the BG)**

Note1: The stamp papers, of appropriate value shall be purchased in the name of bank, which will issue the "Bank Guarantee".

Note 2: The bank guarantee shall be from a Nationalized Indian Bank or reputed foreign commercial Bank acceptable to NHIDCL for Foreign Consultant with counter guarantee from Nationalized Bank. Bank guarantee furnished by a Foreign Consultant shall be confirmed by any Nationalized Bank in India.

NOTE for Issuing Bank (Not to be included in the BG):-

(i) The bank guarantee(s) contain(s) the name, designation and Code number of the officer(s) signing the guarantee(s).

(ii) The address, telephone no. and other details of the Head Office of the Bank as well as of issuing branch should be mentioned on the covering letter of issuing Branch.

(iii) The bank guarantee for Rs. 10,000 and above is signed by at least two officials (or as per the norms prescribed by the RBI in this regard).

(iv) The Bank Guarantee shall be transmitted through SFMS gateway to our banker with following details:

<b>Particulars</b>	<b>Details</b>
<b>Name of the Beneficiary</b>	<b>National Highways and Infrastructure Development Corporation Limited</b>
<b>Beneficiary Bank Account No.</b>	<b>90621010002659</b>
<b>Beneficiary Bank Branch</b>	<b>IFSC CNRB0019062</b>
<b>Beneficiary Bank Branch Name</b>	<b>Transport Bhawan, New Delhi</b>
<b>Beneficiary Bank Address</b>	<b>Syndicate Bank, Transport Bhawan, 1st Parliament street, New Delhi-110001</b>

(v) The confirmation with supporting details if any shall be specifically mentioned in the covering letter issued with the Bank Guarantee.

## **Appendix J**

### **Letter of invitation**

## **Appendix K**

### **Letter of Award**

**Appendix L**

**Minutes of pre-bid meeting**

**Appendix-M**

**Memorandum of Understanding between  
Name of the Lead partner  
And  
Name of the JV Partner/Association**

Whereas the NHIDCL has invited proposal for appointment of Authority's Engineer for (Name of project) hereinafter called the Project.

And Whereas [**Name of the Lead partner**](Lead Partner) and [**Name of the JV Partner**] JV partner/s have agreed to form a Joint Venture to provide the said services to the NHIDCL as Authority's Engineer; and

Now, therefore, it is hereby agreed by and on behalf of the partners as follows:

- (i) [**Name of the Lead partner**] will be the lead partner and [**Name of the JV Partner**] will be the other JV partner/s.
- (ii) [**Name of the Lead partner**](lead partner) shall be the in charge of overall administration of contract and shall be authorised representative of all JV partners for conducting all business for and on behalf of the JV during the bidding process and subsequently, represent the joint venture for and on behalf of the JV for all contractual matters for dealing with the NHIDCL/EPC Contractor if Consultancy work is awarded to JV.
- (iii) All JV partners do hereby undertake to be jointly and severally responsible for all the obligation and liabilities relating to the consultancy work and in accordance with the Terms of Reference of the Request for Proposal for the Consultancy Services.
- (iv) Subsequently, if the JV is selected to provide the desired consultancy services, a detailed MOU indicating the specific project inputs and role of each partner/s along with percentage sharing of cost of services shall be submitted to the NHIDCL (Consultant may submit the detailed MOU along with percentage sharing of cost at the time of bidding also).

<b>For [Name of the Lead partner]</b>	
	Managing Director/Head of the Firm
	Address
<b>For [Name of the JV Partner]</b>	
	Managing Director/Head of the Firm
	Address
<b>For [Name of the Association]</b>	

**DISCLAIMER**

The Applicant must read all the instructions in the RFP and submit the same accordingly.

END OF DOCUMENT

\*\*\*