

REQUEST FOR PROPOSAL

For

Short Term Maintenance work

NAME OF WORK:

Restoration & Repair of Batote Khellani road (existing NH-244) by way of Laying of Bituminous Macadam & Bituminous Concrete, Breast/wall, Pucca & Kachha Drain, Culverts, Road Marking & Road Transverse Strips, Delineators, Flickering Cat eyes etc., from Km 0.000 to Km 45.000 on Batote-Khellani stretch of existing NH-244 in the UT of Jammu & Kashmir for FY 2025-26

[Contract Package No.: NHIDCL/RO(JMU)/NH-244/M&R/B-K/308/2025-26]



**National Highways Infrastructure Development Corporation
Limited**

NATIONAL COMPETITIVE BIDDING
(Based on Single Percentage Rate)

(THROUGH E-TENDERING MODE)

**RFP Submitted for Amounting Rs. 6,34,54,713.00 /- (Excl. of GST)
(Rupees Six Crore Thirty-Four Lakhs Fifty-Four Thousand Seven Hundred
and Thirteen Only)**

REGIONAL OFFICE – Jammu
National Highways & Infrastructure Development Corporation Ltd.
(A Government of India Undertaking)

JUNE - 2025

CONTENTS

Description

- | | |
|------------------|--|
| Section 1 | Notice Inviting Tender |
| Section 2 | Instructions to Bidders (ITB) and Appendix to ITB |
| Section 3 | Qualification Information |
| Section 4 | Forms of Bank Guarantees, Letter of Acceptance (LoA) and Agreement |
| Section 5 | General Conditions of Contract (GCC) and Contract Data |
| Section 6 | Addendum to General Conditions of Contract |
| Section 7 | Road Maintenance Standards and Specifications for Road Maintenance Works, Part-I and Part II & Scope of Work |
| Section 8 | Implementation Manual & Maintenance Intervention Level |
| Section 9 | Financial Bid Form and Bill of Quantities |

SECTION - 1 NOTICE INVITING TENDER
(E-TENDERING MODE ONLY)

SECTION - 1

NOTICE INVITING TENDER

Availability of bid documents on website from 25-06-2025(17:00 Hrs.) to 15-07-2025 (17:00 Hrs.)

Date of Pre-bid meeting: 10-07-2025 (at 15:00 Hrs)

Date of reply of Pre-bid queries: 11-07-2025 (at 17:00 Hrs)

Bid submission start date is 12.07.2025 (at 10:00 Hrs)

Last date for online submission of the Bid is 15-07-2025 (upto 17:00 Hrs.)

Deadline for physical submission of original documents and bid: 15-07-2025 (upto 17:00 Hrs.)

Opening of technical bids: 16-07-2025 (at 11:00 Hrs.)

Opening of financial bids: To be intimated later on.

Validity of bids: 120 Days from the Bid Due Date

SECTION: 1

NOTICE INVITING TENDER

NHIDCL/RO(JMU)/NH-244/M&R/B-K/308/2025-26

Dated: 25.06.2025

1. The National Highways and Infrastructure Development Corporation Ltd., (the "Authority") is engaged in the development of National Highways and as part of this endeavor, "the Authority" has decided to undertake the invites Bids through e-tendering from experienced firms/organizations for maintenance works and activities for the following sections of the National Highway roads:

Sr. No.	Section	Length (km)	Estimated Civil Cost Put to Tender (Rs. In Lakh)	Bids Security (Rs. In Lakh)	Contract Duration (months)	DLP (Months)
1.	Restoration & Repair of Batote Khellani road (existing NH-244) by way of Laying of Bituminous Macadam & Bituminous Concrete, Breast/wall, Pucca & Kachha Drain, Culverts, Road Marking & Road Transverse Strips, Delineators, Flickering Cat eyes etc., from Km 0.000 to Km 45.000 on Batote-Khellani stretch of existing NH-244 in the UT of Jammu & Kashmir for FY 2025-26.	45.000 Km	634.55	6.35	09 (Nine) for Construction)	12 Months

Cost of Bid Documents (Non-Refundable) : Rs. 11,800/- (Rupees Eleven Thousand Eight Hundred Only) to through RTGS into bank as mentioned hereunder-

S.No.	Particulars	Details
1	Name of Beneficiary	National Highways & Infrastructure Development Corporation Limited
2	Beneficiary Bank Account No.	76411010002171
3	Beneficiary Bank Branch	IFSC CNRB0002975
4	Beneficiary Bank Branch Name	Canara Bank, Channi-Himmat
5	Beneficiary Bank Address	Canara Bank, Channi-Himmat, Jammu, J&K, 180015

e-Tender Processing fee (Non-Refundable) : Rs. NIL

2. The preliminary requirements (detailed requirements are given in the Bid Documents) of bidding firm / contractor for above work are mentioned as under: -

Average Turn-over during last 3 years (Rs. in lakh.)	Work of similar nature during last 5 years (Rs. In lakh.)
Minimum Average Annual Turnover 634.55 lakh.	1. Single work of Rs. 317.28 lakh or 2. Two similar work each of Rs. 222.09 Lakh. or 3. Three Similar work each of Rs. 158.64 lakh.

3. The Scope of Work constitute slope protection work & restoration of the road includes the routine maintenance of all the assets and facilities existing & constructed within Right of Way (ROW) on the above-mentioned section including maintenance of carriageway, shoulders, drains, road signage etc., and carrying out other works as specified in the bid documents.

4. To participate in the bidding, it is mandatory for the Bidders to get registered their firm with e-procurement portal <https://eprocure.gov.in/eprocure/app> to have user ID & password which has to be obtained free of cost. Following may kindly be noted:

- (a) Registration with e-procurement portal should be valid at least up to the date of submission of BID.
- (b) BIDs can be submitted only during the validity of registration.

The Bidders shall update their project and other details on the portal on a regular basis and apply to the tenders via the portal. Bidders are also required to get registered their firm with Bidder Information Management System (BIMS)Portal.

5. The complete Bid Documents can be viewed/downloaded from the official portal of the CPPP website (<https://eprocure.gov.in/eprocure/app>) from **25-06-2025 (17:00 Hrs.) to 15-07-2025 (17:00 Hrs.)**. The amendments/ clarification to the Bid Document, if any, will be hosted on the above website.

The bidder is required to submit, along with its BID, the cost of BID/RFP document, i.e. **Rs.11,800/- (Rupees Eleven Thousand Eight Hundred Only) to through RTGS into bank as mentioned hereunder-**

S.No.	Particulars	Details
1	Name of Beneficiary	National Highways & Infrastructure Development Corporation Limited
2	Beneficiary Bank Account No.	76411010002171
3	Beneficiary Bank Branch	IFSC CNRB0002975
4	Beneficiary Bank Branch Name	Canara Bank, Channi-Himmat
5	Beneficiary Bank Address	Canara Bank, Channi-Himmat, Jammu, J&K, 180015

Failure to submit either of the above will result in rejection of bids.

6. The Bid should be submitted online in the prescribed form at given on the website. No other mode of submission is acceptable.

7. The authorized signatory holding Power of Attorney shall only be the Digital Signatory. In case authorized signatory holding Power of Attorney and Digital Signatory are not the same, the bid shall be considered non-responsive.

8. The last date for online submission of the Bid is **15-07-2025 (17:00 Hrs.)**. (as mentioned on the e-portal only) ("**Bid Due Date**"). Bidder must submit its Financial Bid and Technical Bid on CPPP e-procurement portal within the above deadline.

The technical bid would be opened **16-07-2025 (at 11:00 Hrs.)** online at office of the **National Highways & Infrastructure Development Corporation Ltd. House no. 261, Sector -06,**

Channi- Himmat, Jammu, 180015 on the date and time as mentioned above. However, such representatives shall be allowed to attend the opening of the bids only if they produce letter of authority on the letterhead of the bidder, at the time of opening of bids as mentioned above.

9. The amount of Bid Security/Earnest Money is **6.35 Lac.** to be submitted in the form of **e-Bank Guarantee/Demand Draft/Bankers Cheque/FDR** only (any other form will not be acceptable) of any scheduled commercial bank approved by RBI having a net worth of not less than Rs.500 crore as per the latest annual report of the bank and must be in the name of the Employer. In case of foreign bank (issued by a branch in India) the net worth in respect of the Indian operations shall only be taken into account. It shall be valid for 45 days beyond the validity of the bid. Any bid having bid security for lesser value and shorter validity period shall be treated as non-responsive. Any Bid not accompanied by Bid Security shall also be treated as NON-RESPONSIVE. Bank Guarantee/ Demand Draft (See Clause 16 of Section-2). For further details and step by step process regarding e-BG and online payment, NHIDCL Office Order dated 22nd March 2023 may be referred, which is attached as Appendix-A.

10. The period of validity of bid is 120 days from the deadline of submission of bid.

For any clarification, the office of the undersigned may be contacted.

Officer In-charge

Executive Director (Projects)

National Highways & Infrastructure Development Corporation Ltd.

House no. 261, Sector -06, Channi- Himmat, Jammu, 180015

Email- rojammunhidcl@gmail.com

Mobile No. – 9419301579

Contact Person – DGM (P), RO-Jammu.

SECTION-2

INSTRUCTIONS TO BIDDERS (ITB) AND APPENDIX TO ITB

SECTION - 2

INSTRUCTIONS TO BIDDERS (ITB)

TABLE OF CLAUSES

Clause	A. General	Clause	D. Submission of Bids
1.	Scope of Bid	20.	Deadline for Submission of Bids
		21.	Late Submission of Documents in Physical Form
2.	Source of Funds	22.	Modification and Withdrawal of Bids
3.	Eligible Bidders		E. Bid Opening, Clarification of Bids and Evaluation
4.	Qualification of the Bidder	23.	Bid Opening, Clarification of Bids And Evaluation
5.	One Bid per Bidder	24.	Process to be Confidential
6.	Cost of Bidding	25.	Contacting the Employer
7.	Site Visit	26.	Examination of Bids and Determination of Responsiveness
	B. Bidding Documents	27.	Correction of Errors
8.	Content of Bidding Documents	28.	Evaluation and Comparison of Financial Bids
9.	Clarifications on Bidding Documents		F. Award of Contract
10.	Amendment of Bidding Documents	29.	Award Criteria
	C. Preparation of Bids	30.	Employer's Right to Accept any Bid and to Reject any or all Bids
11.	Language of Bid	31.	Notification of Award and Signing of Agreement
12.	Documents Comprising the Bid	32.	Performance Security
13.	Bid Prices	33.	Advances
14.	Currencies of Bid and Payment		G. Corrupt or Fraudulent Practices
15.	Bid Validity	34.	Corrupt or Fraudulent Practices
16.	Earnest Money/ Bid Security/ Forfeiture/ Debarment		H. Labour Laws and Fundamental Breach
17.	Alternative Proposals by Bidders	35.	Labour Laws and Regulations
18.	Format and Signing of Bid	36.	Fundamental Breach and other Obligations
19.	Marking of Bids		Appendix to ITB

A. GENERAL

1. Scope of Bid

- 1.1** The Employer (as defined in the Appendix to ITB) invites Single Percentage Rate bids through the process of e-tendering for works as described in these documents and referred to as “the Works”. The name and identification number of the Works is as defined in the **Appendix** to ITB.
- 1.2** The successful Bidder will be expected to complete the Works by the intended Completion Date specified in the Contract Data.
- 1.3** Throughout these Bidding Documents, the terms “bid” and “tender” and their derivatives (bidder/tenderer, bid/tender, bidding/tendering, etc.) are synonymous.

2. Source of Funds

- 2.1** The expenditure under this contract will be met by NHIDCL.

3. Eligible Bidders

- 3.1** This Invitation for Bids is open to all bidders meeting the qualification requirements prescribed in **Clause 4** of ITB.
- 3.2** Any entity which has been black listed or barred by the Central or any State Government or any public sector undertaking, autonomous body or any authority under the Central or State Government, from participating in any project, and the bar subsists as on the date of Application shall not be eligible to submit the bid.

4. Qualification of the Bidder

- 4.1** All bidders shall furnish the following information and documents with their Bids in **Section-3**, Qualification Information, unless otherwise stated in the **Appendix** to ITB.
- a) Scanned copies of original documents defining the constitution or legal status, place of registration, and principal place of business; scanned copy of written power of attorney of the signatory of the Bid to commit the Bidder; and original copy of Written Power of Attorney to be submitted in the envelope of physical form (refer **Clause 12.2** of ITB).
- b) Scanned copy of total monetary value of civil engineering construction and maintenance works performed for each of the last three years.
- c) Scanned copy of experience certificate in works of a similar nature and size for each of the last five years with certificates from the concerned officer of the rank of Executive Engineer or equivalent or higher *employed in Govt./ Govt. undertaking*.
- d) Scanned copy of evidence of availability (either owned or leased or rented) of items of construction and maintenance equipment named in **Clause 4.3B (b) (i)**.
- e) Scanned copy of details of the technical personnel proposed to be employed for the Contract having the qualifications defined in **Clause 4.3B (b)(ii)**.

- f) Scanned copy of reports on the financial standing of the Bidder, and a certificate from Chartered Accountant as a proof of turnover for the last three years.
- g) Scanned copy of information regarding any litigation or arbitration during the last five years in which the Bidder is involved, the parties concerned, the disputed amount, and the present status.
- h) Undertaking that the bidder is not affiliated to the firm or entity that has been hired or employed by the Employer for preparation of bid documents or to supervise the contract.

4.2 Bids from joint ventures/consortiums are not allowed.

4.3 A **To qualify for a ward of the contract, each bidder in its name should have the following: -**

- a) **Achieved a minimum average annual financial turnover (in all classes of civil engineering construction and maintenance works only) equal to the amount indicated in NIT during last three years ending 31st March of the previous financial year duly certified by Chartered Accountant.**
- b) **satisfactorily completed (not less than 90% of contract value)**, as a prime contractor or as a partner of JV for similar works during last five years ending last day of month previous to the one in which bids are invited, either of the following:
 - i. three similar completed works costing not less than amount equal to **Rs. 317.28 Lakh each**
 - ii. two similar completed works costing not less than amount equal to **Rs. 222.09 lakh. each.**
 - iii. one similar - completed work costing not less than amount equal to **Rs. 158.64 Lakh.**
 - iv. The similar work constitutes construction/maintenance of roads.

The following escalation factors shall be used to bring the value of such completed works to the Level of current financial year:

<u>Year Before</u>	<u>Multiplying Factor</u>
2023-24.....	1.1
2022-23.....	1.21
2021-22.....	1.33
2020-21.....	1.46
2019-20.....	1.61

4.3 B (a) Each bidder must upload the scanned copies of following documents along with the submission of online bid:

- i) An affidavit on a Stamp Paper, duly attested from the Notary Public, that the Information furnished with the bid documents is correct in all respects; and
- ii) Such other certificates as defined in **Section-3.**

Failure to submit the certificates/ documents as specified above shall make the bid non responsive.

(b) Each bidder must demonstrate for this work:

- i) Evidence of availability (either owned or leased or rented) of the key equipment for this work as stated in the **Appendix** to ITB.
- ii) Availability of personnel with qualification and experience as stated in the **Appendix** to ITB.

4.4 Bidders who meet the minimum qualification criteria will be qualified only if their available bid capacity is more than the total bid value. The available bid capacity will be calculated as under:

$$\text{Available Bid capacity} = (A*N*2.5-B)$$

Where,

A = Maximum value of civil engineering works executed in any one year during the last **three** years (escalation factor as specified in this section shall be used to bring the maximum value of civil engineering works to the level of current financial year i.e., **2024-25**) taking into account the completed as well as works in progress.

N = Number of years prescribed for completion of the works for which bid is invited.

B = Value (escalation factor as specified in this section shall be used to bring the value to the level of current financial year i.e., **2024-25**) of existing commitments and on-going works to be completed during the next **1 year** (period of completion of the works for which bid is invited)

4.5 Even though the bidders meet the above qualifying criteria, they are subject to be Disqualified if they have:

- i) made misleading or false representations in the forms, statements, affidavits and attachments submitted in proof ; and/or
- ii) Record of poor performance such as abandoning the works, not properly completing the contract, inordinate delays in completion, litigation history, or financial failures etc. or debarring from work etc.

5. One Bid per Bidder

5.1 Each Bidder shall submit only one Bid for the Works. A Bidder who submits more than One Bid will cause such bids to be disqualified.

6. Cost of Bidding

6.1 The Bidder shall bear all costs associated with the preparation and submission of his Bid, and the Employer will, in no case, be responsible or liable for those costs.

7. Site Visit

7.1 The Bidder, at his own cost, responsibility and risk, is encouraged to visit, examine and familiarize himself with the Site of Works and its surroundings including source of earth, water, road aggregates, availability of labour etc. and obtain all information that may be necessary for preparing the Bid and entering into a contract for undertaking the maintenance Works. The costs of visiting the site shall be at the Bidder's own expense. For this purpose, he may contact the person whose contact details are given in the **Appendix** to ITB.

B. BIDDING DOCUMENTS

8. Content of Bidding Documents

8.1 The set of bidding documents comprises the documents listed below and addenda (if any) issued in accordance with **Clause 10**:

Section 1: Notice Inviting Tender

Section 2: Instructions to Bidders (ITB) and Appendix to ITB

Section 3: Qualification Information

Section 4: Forms of Bank Guarantee, Letter of Acceptance (LOA) and Agreement

Section 5: General Conditions of Contract and Contract Data

Section 6: Addendum to General Conditions of Contract

Section 7: Road Maintenance Standards and Specifications for Road Maintenance Work, Part-I and Part-II

Section 8: Drawings and Schedule of Drawings

Section 9: Financial Bid form and Bill of Quantities

8.2 The bidder is expected to examine carefully all instructions, conditions of contract, contract data, forms, scope, road maintenance Standards and Specifications, bill of quantities, etc. in the Bid Documents. Failure to comply with the requirements of Bid Documents shall be at the bidder's own risk. Pursuant to **Clause 26** here of, Bids, which are not substantially responsive to the requirements of the Bid Documents, shall be rejected.

9. Clarifications on Bid Documents

9.1 A prospective Bidder requiring any clarification on the Bid Documents may notify the Employer in writing or through e-tender portal at the Employer's address indicated in the notice inviting Tender. The Employer will respond to any such request for clarification received till date of the pre-bid query. Copies of the Employer's response will be hosted on website including a description of the queries but without identifying its source.

9.2 Pre-Bid Meeting

9.2.1 The Bidder's authorised representative is invited to attend a pre-bid meeting, if it is indicated in the **Appendix** to ITB. The purpose of the pre-bid meeting will be to clarify issues and to answer questions on any matter that may be raised at that stage.

9.2.2 The bidder is requested to submit any questions in writing so as to reach the Employer not later than one week before the meeting.

9.2.3 Minutes of the meeting, including the text of the questions raised (without identifying the source of the enquiry) and the responses given will be posted without delay on website. Any modifications of the bid documents listed in **Clause 8.1**, which may become necessary as a result of the pre-bid meeting or which are required in the opinion of the Employer shall be made by the Employer exclusively through the issue of an Addendum pursuant to **Clause 10** and not through the minutes of the pre-bid meeting.

9.2.4 Non-attendance at the pre-bid meeting will not be a cause for disqualification of a bidder.

10. Amendment of Bidding Documents

- 10.1** Before the deadline for submission of bids, the Employer may modify the Bidding Documents by issuing addenda.
- 10.2** Any addendum thus issued shall be part of the Bidding Documents and shall be hosted on e-tendering portal. Bidders are advised to keep themselves updated of all the addenda issued on e-tendering portal by daily checking the e-tendering portal and the Employer does not assume any responsibility in case the bidder fails to do so and does not take any action, if required, with respect to any relevant addendum.
- 10.3** To give prospective bidders reasonable time to take an addendum into account in preparing their bids, the Employer shall extend, as necessary, the deadline for submission of bids, in accordance with **Clause 20.3**.

C. PREPARATION OF BIDS

11. Language of Bid

- 11.1** All documents relating to the Bid shall be in English.

12. Documents Comprising the Bid

- 12.1** The e-bid submitted by the bidder shall be in two separate parts namely Part-I and Part-II. Part-I shall be named Technical Bid and shall comprise of information submitted in **Section-3**. Part-II shall be named Financial Bid and shall comprise of Bill of Quantities-Bill no. 1 to 2.

- 12.2** Documents to be submitted in physical form must be delivered **by 15-07-2024 (upto 17:00 Hrs.)**.

Though, the scanned copies of following documents is required to be uploaded during submission of e-bid on the e-tendering portal as per **Clause 12.1** above, however, following original documents in physical form shall be submitted in a sealed envelope on or before **by 15-07-2024 (upto 17:00)** or before the time of submission as specified in NIT at the address indicated in **Clause 20**, duly super scribed "Name of Work, Bid Due Date and time". Name and address of the bidder should also be indicated on the envelope.

- i) Copy of Acknowledgement for Tender Submission and EMD/Bid Security
- ii) Bid Document Fee
- iii) Deleted**
- iv) Written Power of Attorney of the signatory (whose digital signature certificate is used during e-tender submission) of the bidder to commit the Bid.
- v) Affidavit duly notarized (as per the format provided in **Section-3**)

- 12.3** The following documents, which are not submitted with the bid, will be deemed to be part of the bid.

- i) Notice Inviting Tender
- ii) Instructions to the Bidders and Appendix to ITB
- iii) General Conditions of Contract and Contract Data
- iv) Addendum to General Conditions of Contract

- v) Road Maintenance Standards and Specifications for Road Maintenance Works, Part-I and Part-II
- vi) Drawings and Schedule of Drawings

13. Bid Prices

13.1 The Contract shall be for the whole Works, as described in **Clause 1.1** based on the Bill of Quantities- Bill no. 1 to 3 submitted by the Bidder.

13.2 The Bidder shall quote single percentage rate above/below the BoQ/ scheduled rates On appropriate form at enclosed as part of tender document on e-tender portal <https://eprocure.gov.in/eprocure/app>

13.3 All duties, taxes, including GST, royalties and other levies payable by the Contractor under the Contract, or for any other cause, shall be included in the rates, prices, and total bid price submitted by the Bidder.

13.4 The rates and prices quoted by the Bidder shall be fixed for the duration of the Contract And shall not be subject to adjustment.

14. Currencies of Bid and Payment

All payments shall be made in Indian Rupees.

15. Bid Validity

15.1 Bids shall remain valid for a period of 120 days after the deadline date for bid submission specified in **Clause 20**. A bid valid for a shorter period shall be rejected by the Employer as non-responsive.

15.2 In exceptional circumstances, prior to expiry of the original time limit, the Employer may request that the Bidders may extend the period of validity for a specified additional period. The request and the Bidders' responses shall be made in writing. A Bidder may refuse the request without forfeiting his bid security. A Bidder agreeing to the request will not be required or permitted to modify his bid, but will be required to extend the validity of his bid security for a period of the extension, and in compliance with **Clause 16** in all respects.

16. Earnest Money/Bid Security/Forfeiture/Debarment

16.1 The Bidder shall furnish, as part of the Bid, Earnest Money/Bid Security, in the amount as specified in the NIT. **e-Bank Guarantee/Demand Draft/Bankers Cheque only must be in favour of NHIDCL payable at Jammu.**

16.2 The Earnest Money/ Bid Security shall, at the Bidder's option, be in the form of **e-Bank Guarantee/Demand Draft/Bankers Cheque only** (any other form will not be acceptable) of any scheduled commercial bank approved by RBI having a net worth of not less than Rs. 500 crore as per the latest annual report of the bank and must be in the name of the Employer. In case of foreign bank (issued by a branch in India) the net worth in respect of the Indian operations shall only be taken into account. It shall be valid for 45 days beyond the validity of the bid. Any bid having bid security for lesser value and shorter validity period shall be treated as non-responsive. Any Bid not accompanied

by Bid Security shall also be treated as NON-RESPONSIVE. For further details and step by step process regarding e-BG and online payment, NHIDCL Office Order no. NHIDCL/F&A-25/2019-20/E-182855/516 dated 22nd March 2023 may be referred, which is attached as Appendix-A.

16.2.1 For E-BGs, Entity ID of NHIDCL is AAECN7759E, which may be quoted for getting EBG. The E-BGs shall be as per the format specified in Appendix N of this RFP document and shall be valid for 45 days beyond the validity of the bid. The bank details (Bank Name, IFSC etc.) are given below:

S.No.	Particulars	Details
1	Name of Beneficiary	National Highways & Infrastructure Development Corporation Limited
2	Beneficiary Bank Account No.	76411010002171
3	Beneficiary Bank Branch	IFSC CNRB0002975
4	Beneficiary Bank Branch Name	Canara Bank, Channi-Himmat
5	Beneficiary Bank Address	Canara Bank, Channi-Himmat, Jammu, J&K, 180015

No BG shall be accepted in the physical form. However, in cases where the bidders are facing difficulties in getting e-BG, such bidder may approach NHIDCL. The physical BG can be accepted in such circumstances. For Further details, the bidders may visit the website of National E Governance Services Limited at <https://nesl.co.in/ebg/>. Also, the bidders may refer to the Office Order of NHIDCL displayed on the website <https://nhidcl.com/wpcontent/uploads/2023/03/Notice-for-e-PBGTender-Fee-and-EMD.pdf> for ready reference. The Bid submitted without Bid Security will be summarily rejected. For further details and step by step process regarding e-BG and online payment, NHIDCL Office Order dated 22nd March 2023 may be referred, which is attached as Appendix-A.

A. e-Bank Guarantee or Demand Draft/Bankers Cheque/RTGS/ NEFT receipts, in the name of the Employer, from following banks would be accepted: -

- i. State Bank of India or its subsidiaries,
- ii. Any Indian Nationalized Bank
- iii. IDBI / ICICI Bank
- iv. **A Foreign Bank (issued by a branch outside India) with a counter guarantee from SBI or its subsidiaries or any Indian Nationalized Bank.**
- v. Any Scheduled Commercial Bank approved by RBI having a net worth of not less than Rs. 500 Crores as per the latest Annual Report of the Bank. In the case of a Foreign Bank (issued by a branch in India), the net worth in respect of the Indian operations shall only be taken into account.

B. The acceptance of the guarantees shall also be subject to the following conditions: -

- i. The capital adequacy of the Bank shall not be less than the norms prescribed by RBI (presently 9, with effect from 31st March, 2003,).
- ii. The e-bank guarantee issued by a Cooperative Bank shall not be accepted.

16.3. Any Bid not accompanied by an acceptable Earnest Money, shall be rejected by the Employer as non-responsive.

16.4 Bid securities of the unsuccessful bidders should be returned to them at the earliest after expiry of the final bid validity and latest on or before the 30th day after the award of the contract.

16.5. The Earnest Money of the successful Bidder will be discharged when the Bidder has signed the Agreement and furnished the required Performance Security.

16.6 The Bid Security/Earnest Money will be forfeited:

- (a) If the Bidder withdraws the Bid after its submission during the period of Bid validity;
- (b) If a Bidder withdraws its BID during the period of Bid validity as specified in this RFP and as extended by mutual consent of the respective Bidder(s) and the Employer;
- (c) In the case of Successful Bidder, if the Bidder fails within the specified time limit to -
 - (i) sign the Agreement; and/or;
 - (ii) furnish the required Performance Security;

16.7 In case of forfeiture of bid security, the bidder shall also be debarred from participation in the works of Ministry of Road Transport & Highways for a period as decided by MoRT&H.

17. Alternative Proposals by Bidders

17.1 Bidder shall submit offers that fully comply with the requirement of the Bidding Documents. Conditional offer or alternate offer will not be considered further in the process of evaluation and such a bid will be declared non-responsive.

18. Format and Signing of Bid

18.1 The Bidder shall submit-bid comprising the documents as described in **Clause12** of the ITB.

18.2 The documents to be submitted in the physical form along with the financial instrument for fees/security shall be typed or written in ink and shall be signed by a person duly authorized to sign on behalf of the Bidder. All the pages of the documents as mentioned here shall be signed by the person/ persons signing the Bid. Documents as mentioned here shall contain no over writing, alterations or additions, except those to comply with instructions, issued by the Employer or as necessary to correct errors made by the Bidder, in which case such corrections shall be made by scoring out the cancelled portion, writing the correction and signing and dating it along with the stamp by the person or persons signing the Bid.

D. SUBMISSION OF BIDS

19. Marking of Bids

19.1 The documents to be submitted in physical form as per **Clause 12.2** of ITB shall be submitted in a sealed Envelope super scribed as “Documents in Physical Form” at the top left corner.

In case of any discrepancy between documents submitted online and documents submitted in the physical form, the documents submitted in physical form shall prevail over the documents submitted through online process.

20. Dead line for Submission of Bids

20.1 The Bidder shall ensure that the complete e-Bid is uploaded on the e-tender portal on or before the Bid Due Date and before the time specified in NIT/e-portal. The Bidder is further required to submit Documents in Physical Form on or before the time of submission as specified in NIT, at the following address:

Executive Director (Projects)
National Highways & Infrastructure Development Corporation Ltd.
House no. 261, Sector -06, Channi- Himmat, Jammu, 180015
Email- rojammunhidcl@gmail.com
Mobile No. - 9419301579
Contact Person – DGM (P), RO-Jammu.

In the event of the specified date for the submission of Documents in Physical Form being declared a holiday for the Employer, the same will be received up to the specified time on the next working day.

20.2 The Employer assumes no responsibility for inability of a bidder to submit bids through the Employer’s e-tendering portal on account of delay in submission at bidder’s end. Bidders shall ensure that they submit the bid well before the “Bid Due Date and Time of Bid-Submission”. The Employer shall not be responsible if bidder is not able to submit the bid on account off failure in network / internet connection or any other reason whatsoever.

20.3 The Employer may extend the deadline for submission of bids by issuing an amendment in accordance with **Clause 10**, in which case all rights and obligations of the Employer and the bidders previously subject to the original deadline will then be subject to the new deadline.

21. Late Submission of Documents in Physical Form:

21.1 Any document in physical form if received by the Employer after the deadline prescribed

in **Clause 20** will be returned unopened to the Bidder and also the e-bid submitted by such Bidder shall not be considered.

22. Modification and Withdrawal of Bids

22.1 Bidders may modify or withdraw their e-bids as directed on the e-tendering portal, before the Bid Due Date and time as prescribed in **Clause20**.

22.2 No bid may be modified after the deadline for online submission of bids.

22.3 Withdrawal or modification of a Bid between the deadline for submission of bids and the expiration of the original period of bid validity specified in **Clause 15.1** or as extended pursuant to **Clause15.2** shall result in the forfeiture of the Bid Security pursuant to **Clause16**.

22.4 Bidders may modify the prices of their bids before deadline of online submission of bid.

22.5 No Late and delayed bids after Bid Due Date and time shall be permitted in e-tendering portal System. Time being displayed on e-Tendering Portal shall be final and binding on bidders and bids have to be submitted by bidders considering this time only and not the time as per their location/country.

E. BID OPENING, CLARIFICATION OF BIDS AND EVALUATION

23. Bid Opening, Clarification of Bids and Evaluation

23.1 Bid opening shall be carried out in two stages. Firstly, Part-I 'Technical Bid' of all the Bidders received (except those received late) shall be opened on the date and time mentioned in Notice Inviting Tender (NIT). Part-II' Financial Bid' of those bidders whose technical bid has been determined to be substantially responsive shall be opened on a subsequent date through online process of e-tendering, which will be notified to such bidders.

The Employer will open the "Technical Bid" of all the Bids received (except those received late), in the presence of the Bidders/ Bidders' representatives who choose to attend at the time, date and place specified in the NIT. In the event of the specified date for the submission of bids being declared a holiday for the Employer, the Bids will be opened at the appointed time and location on the next working day.

23.2 In all cases, the amount of Earnest Money, forms and validity shall be announced. Thereafter, the Employer at the opening as the Employer may consider appropriate, will announce the Bidders' names and such other details.

23.3 The Employer will prepare minutes of the Bid opening, including the information disclosed to those present in accordance with this **Clause23**.

23.4 The bids accompanied with valid bid security & bid document fee will be taken up for evaluation with respect to the Qualification In formation and other information furnished in Part I of the bid pursuant to **Clause12.1**.

As soon as possible, the Evaluation Committee will finalize the list of responsive bidders whose

financial bids are eligible for consideration. However, to assist in the examination, evaluation of technical bids, the Employer may at his discretion, ask any bidder for clarification of his bid, however, no additional documents in support of clarification will be entertained.

23.5 The Employer shall inform the bidders about the result of technical evaluation by uploading on the web portal giving 3 days time for objections, if any, from the bidders. The Employer shall finalize the evaluation of technical bids after due consideration of objections received and intimate the bidders, whose Technical Bids are found responsive, of the date, time and place of opening of the Financial Bids. The Bidders so informed, or their representative, may attend the event of opening of Financial Bids.

23.6 At the time of the opening of the 'Financial Bid', the names of the bidders whose bids were found responsive in accordance with **Clause 23.5** will be announced. The financial bids of only these bidders will be opened. The responsive bidders' names, the Bid prices, the total amount of each bid, pursuant to **Clause 22** and such other details as the Employer may consider appropriate will be announced by the Employer at the time of bid opening.

23.7 The Employer shall prepare the minutes of the opening of the Financial Bids.

24. Process to be Confidential

24.1 Information relating to the examination, clarification, evaluation, and comparison of bids and recommendations for the award of a contract shall not be disclosed to bidders or any other person not officially concerned with such process until the award to the successful Bidder has been announced. Any attempt by a Bidder to influence the Employer's processing of bids or award decisions may result in the rejection of his Bid

25. Contacting the Employer

25.1 Any effort by the Bidder to influence the Employer in the Employer's bid evaluation, Bid comparison or contract award decisions may result in the rejection of the Bidders' bid.

26. Examination of Bids and Determination of Responsiveness

26.1 During the detailed evaluation of "Technical Bids", the Employer will determine whether each Bid

(a) Meets the eligibility criteria defined in **Clauses 3 and 4**; (b) contains the required documents in physical form and the documents uploaded by the bidder are in order; and (c) is substantially responsive to the requirements of the Bidding Documents. During the detailed evaluation of the "Financial Bids", the responsiveness of the Bids will be further determined with respect to the remaining bid conditions, i.e., bill of quantities, Specifications and drawings etc.

27. Correction of Errors

27.1 Financial Bids determined to be substantially responsive will be checked by the Employer for any arithmetic errors. Errors will be corrected by the Employer as follows:

- a) Where there is a discrepancy between the rates in figures and words, the rates in Words will govern; and

27.2 The amount stated in the Financial Bid will be corrected as per **Clause 27.1** and shall be binding upon the Bidder. If the Bidder does not accept the corrected amount, the Bid shall be rejected and the Bid Security shall be forfeited in accordance with **Clause 16.6 (b)**.

28. Evaluation and Comparison of Financial Bids

28.1 The Employer will evaluate and compare only the bids determined to be substantially responsive in accordance with **Clause 26**.

28.2 If the Bid of the successful Bidder is seriously unbalanced in relation to the Employer's estimate of the cost of work to be performed under the contract, the Employer may require the Bidder to produce detailed price analyses for any or all items of the Bill of Quantities, to demonstrate the internal consistency of those prices with the construction methods and schedule proposed. If, after evaluation of the price analyses, the Employer determines that the bidder has substantially failed to demonstrate its capability to deliver the contract at the offered price, the Employer may reject the Bid/Proposal.

F. AWARD OF CONTRACT

29. Award Criteria

29.1 Subject to **Clause 31**, the Employer will award the Contract to the Bidder whose Bid has been determined to be substantially responsive according to the bidding documents and who has offered the lowest evaluated Bid price.

30. Employer's Right to Accept any Bid and to Reject any or all Bids

30.1 Notwithstanding **Clause 29**, the Employer reserves the right to accept or reject any Bid, and to cancel the bidding process and reject all bids, at any time prior to the award of Contract, without there by incurring any liability to the affected Bidder or bidders or any obligation to inform the affected Bidder or bidders of the grounds for the Employer's action.

31. Notification of Award and Signing of Agreement

31.1 The Bidder whose Bid has been accepted will be notified of the award by the Employer prior to expiration of the Bid validity period by e-mail or facsimile confirmed by registered letter. This letter (hereinafter and in the Part I *General Conditions of Contract* called the "Letter of Acceptance") will state the sum that the Employer will pay to the Contractor in consideration of the execution, completion and maintenance of the Works, and of routine maintenance of roads by the Contractor as prescribed by the Contract (hereinafter and in the Contract called the "Contract Price").

31.2 The notification of award will constitute the formation of the Contract, subject only to the furnishing of a performance security in accordance with the provisions of **Clause 32**.

31.3 The Agreement will incorporate all agreements between the Employer and the successful Bidder. It will be signed by the Employer and the successful Bidder after the performance security is furnished.

31.4 Upon furnishing of the Performance Security by the successful Bidder, the Employer will promptly notify the other Bidders that their Bids have been unsuccessful.

32. Performance Security

32.1 Within 10 (Ten) days after receipt of the Letter of Acceptance, the successful Bidder of receipt of Letter of Acceptance, the selected Bidder shall furnish to the Employer an irrevocable and unconditional guarantee from a Bank in the form set forth in Section 4 (Form of Bank Guarantee for Performance Security) for an amount equal to **3% (Three percent) of the Bid Price.**

In case of bids mentioned below, the Selected Bidder, along with the Performance Security, shall also furnish to the Authority an irrevocable and unconditional guarantee from a Bank in the same form towards an Additional Performance Security (the "Additional Performance Security") for an amount calculated as under:

- (i) If the Bid Price offered by the Selected Bidder is lower than 20% of the estimated project cost/cost put to the Additional Performance Security shall be calculated @ 20% of the difference in the (i) Estimated Project Cost (as mentioned in RFP)-20% of the Estimated Project Cost and (ii) the Bid Price offered by the selected Bidder
- (ii) Maximum limit of additional performance security shall be limited to 3% of the Bid Price offered by the selected Bidder.
- (iii) This "Additional Performance Security" shall be treated as part of performance security.
- (iv) The Selected Bidder has the option to provide 50% of the Performance Security and 50% of the Additional Performance Security, if any, within 10 (Ten) days of receipt of Letter of Acceptance, in any case before signing of the Contract Agreement and the remaining Performance Security and Additional Performance Security, if any, shall be submitted within 10 days of signing of the agreement.

The performance security shall be in the form of a e-Bank Guarantee in the name of the Employer, from a Bank as applicable in case of bid security defined in Appendix to ITB.

Failure of the successful bidder to comply with the requirement of sub-clause 32.1 and 32.2 shall constitute sufficient ground for cancellation of the award and forfeiture of the bid security and debarment for a period of 2 years.

A. Bank Guarantee in the name of the Employer, from following banks would be accepted: -

- i) State Bank of India or its subsidiaries,
- ii) Any Indian Nationalized Bank
- iii) IDBI/ICICI Bank
- iv) A Foreign Bank (issued by a branch outside India) with a counter guarantee from SBI or its subsidiaries or any Indian Nationalized Bank.
- v) Any Scheduled Commercial Bank approved by RBI having a net worth of not less than Rs.500 crore as per the latest Annual Report of the Bank. In the case of a Foreign Bank (issued by a branch in India), the net worth in respect of the Indian operations shall only be taken into account.

B. The acceptance of the guarantees shall also be subject to the conditions that the capital adequacy of the Bank shall not be less than the latest norms prescribed by RBI.

C. The bank guarantee issued by a Cooperative Bank shall not be accepted.

32.2 The performance security shall be Valid until **60 (Sixty days)** after the Defects Liability Period.

32.3 For avoidance of any doubt, in case of failure of submission of Performance Security within the stipulated time period, the award shall be deemed to be cancelled / withdrawn. There upon all rights, privileges, claims and entitlements of the Contractor under or arising out of the Award shall be deemed to have been waived by, and to have ceased with the concurrence of the Contractor, and the Award shall be deemed to have been withdrawn by the Employer.

32.4 The agreement will be executed within **10 days** of receipt of Performance Security.

32.5 Notwithstanding anything to the contrary contained in this RFP, Performance Security for an amount equal to **3% (three percent)** of the Bid Price shall be applicable for all tenders/contracts issued till 31.12.2021, in accordance with DoE's OM No. F.9/4/2020-PPD dated 12.11.2020. Rate of Performance Security to be adopted for Contracts finalized after 31.12.2021 shall be governed by applicable policies at that period.

33. Advances

33.1 The Employer will provide Mobilization Advance as provided in Part I General Conditions of Contract.

G. CORRUPT OR FRAUDULENT PRACTICES

34. Corrupt or Fraudulent Practices

34.1 The bidders and their respective officers, employees, agents and advisers shall observe the highest standard of ethics during the bidding process. Notwithstanding anything to the contrary contained herein, the Employer may reject any bid without being liable in any manner what so ever to the bidder if it determines that the bidder has, directly or indirectly or through an agent, engaged in corrupt practice, fraudulent practice, coercive practice, undesirable practice or restrictive practice in the bidding process.

34.2 Without prejudice to the rights of the Employer under **Clause 34.1** hereinabove, if any bidder is found by the Employer to have directly or indirectly or through an agent, engaged or indulged in any corrupt practice, fraudulent practice, coercive practice, undesirable practice or restrictive practice during the bidding process, such bidder shall not be eligible to participate in any tender issued by the Employer during a period of 2(two) years from the date such bidder is found by the Employer to have directly or indirectly or through an agent, engaged or indulged in any corrupt practice, fraudulent practice, coercive practice, undesirable practice or restrictive practice, as the case may be.

34.3 For the purposes of this **Clause 34**, the following terms shall have the meaning hereinafter respectively assigned to them:

- a) "corrupt practice" means the offering ,giving, receiving, or soliciting, directly or indirectly, of anything of value to influence the actions of any person connected with the bidding process (for avoidance of doubt, offering of employment to, or employing, or engaging in any manner whatsoever, directly or indirectly, any official of the Employer who is or has been associated in any manner, directly or indirectly, with the bidding process or has dealt with matters concerning the Contract or arising there from, before or after the execution thereof, at any time prior to the expiry of one year from the date such official

resigns or retires from or otherwise ceases to be in the service of the Employer, shall be deemed to constitute influencing the actions of a person connected with the bidding process); engaging in any manner whatsoever, whether during the bidding process or after the award or after the execution of the Contract, as the case may be, any person in respect of any matter relating to the Works, who at any time has been or is a legal, financial or technical adviser of the Employer in relation to any matter concerning the Works;

- b) “fraudulent practice” means a mis representation or omission off acts or suppression off acts or disclosure of incomplete facts, in order to influence the bidding process;
- c) “coercive practice” means impairing or harming or threatening to impair or harm, directly or indirectly, any person or property to influence any person’s participation or action in the bidding process;
- d) “undesirable practice” means establishing contact with any person connected with or employed or engaged by the Employer with the objective of canvassing, lobbying or in any manner influencing or attempting to influence the bidding process; and
- e) “restrictive practice” means forming a cartel or arriving at any understanding or arrangement among bidders with the objective of restricting or manipulating a full and fair competition in the bidding process.

The Employer requires the Bidder/Contract or to strictly observe the laws against fraud and corruption enforced in India, namely Prevention of Corruption Act, 1988.

H. LABOUR LAWS AND FUNDAMENTAL BREACH

35. Labour Laws and Regulations

35.1 The Bidders shall be aware of the provisions of various Labour Laws, Regulations and Welfare Measures applicable for Construction Workers in India, and other obligations stated in the Conditions of Contract.

36. Fundamental Breach and other obligations

36.1 The Bidders shall be aware of the provisions of Fundamental Breach and other obligations stated in the Conditions of Contract.

Appendix to ITB

**[THE EMPLOYER SHOULD COMPLETE THIS APPENDIX
BEFORE ISSUING THE BID DOCUMENTS]**

Appendix to ITB																																			
Instructions to Bidders Clause Reference																																			
(1.1)	The Employer is National Highways & Infrastructure Development Corporation Limited, House no. 261, Sector-6, Channi Himmat, Jammu, J&K-180015																																		
(1.1)	Restoration & Repair of Batote Khellani road (existing NH-244) by way of Laying of Bituminous Macadam & Bituminous Concrete, Breast/wall, Pucca & Kachha Drain, Culverts, Road Marking & Road Transverse Strips, Delineators, Flickering Cat eyes etc., from Km 0.000 to Km 45.000 on Batote-Khellani stretch of existing NH-244 in the UT of Jammu & Kashmir for FY 2025-26.																																		
(4.4) B) (b) (i)	<table border="1" style="width: 100%; border-collapse: collapse;"> <thead> <tr> <th style="text-align: center;">Name of the Equipment</th> <th style="text-align: center;">Quantity</th> </tr> </thead> <tbody> <tr> <td>Tipper/Trucks</td> <td style="text-align: center;">6</td> </tr> <tr> <td>Motor Grader</td> <td style="text-align: center;">1</td> </tr> <tr> <td>Dozer</td> <td style="text-align: center;">1</td> </tr> <tr> <td>Front end Loader</td> <td style="text-align: center;">1</td> </tr> <tr> <td>Smooth Wheeled Roller</td> <td style="text-align: center;">1</td> </tr> <tr> <td>Vibratory Roller</td> <td style="text-align: center;">1</td> </tr> <tr> <td>Hydraulic Excavator</td> <td style="text-align: center;">1</td> </tr> <tr> <td>Hot Mix (batch mix) plant with Electronic Control (Minimum 75 TPH Capacity)</td> <td style="text-align: center;">1</td> </tr> <tr> <td>Paver finisher</td> <td style="text-align: center;">1</td> </tr> <tr> <td>Water Tanker</td> <td style="text-align: center;">2</td> </tr> <tr> <td>Bitumen Sprayer</td> <td style="text-align: center;">1</td> </tr> <tr> <td>Tandem Roller</td> <td style="text-align: center;">1</td> </tr> <tr> <td>Generator set (63/100/250 KVA)</td> <td style="text-align: center;">1</td> </tr> <tr> <td>Air compressor</td> <td style="text-align: center;">2</td> </tr> <tr> <td>Mechanical Broom (1250 sqm per hour)</td> <td style="text-align: center;">1</td> </tr> <tr> <td colspan="2">Any other equipment required for carrying out work as per Ministry's specification and direction of NHIDCL.</td> </tr> </tbody> </table>	Name of the Equipment	Quantity	Tipper/Trucks	6	Motor Grader	1	Dozer	1	Front end Loader	1	Smooth Wheeled Roller	1	Vibratory Roller	1	Hydraulic Excavator	1	Hot Mix (batch mix) plant with Electronic Control (Minimum 75 TPH Capacity)	1	Paver finisher	1	Water Tanker	2	Bitumen Sprayer	1	Tandem Roller	1	Generator set (63/100/250 KVA)	1	Air compressor	2	Mechanical Broom (1250 sqm per hour)	1	Any other equipment required for carrying out work as per Ministry's specification and direction of NHIDCL.	
Name of the Equipment	Quantity																																		
Tipper/Trucks	6																																		
Motor Grader	1																																		
Dozer	1																																		
Front end Loader	1																																		
Smooth Wheeled Roller	1																																		
Vibratory Roller	1																																		
Hydraulic Excavator	1																																		
Hot Mix (batch mix) plant with Electronic Control (Minimum 75 TPH Capacity)	1																																		
Paver finisher	1																																		
Water Tanker	2																																		
Bitumen Sprayer	1																																		
Tandem Roller	1																																		
Generator set (63/100/250 KVA)	1																																		
Air compressor	2																																		
Mechanical Broom (1250 sqm per hour)	1																																		
Any other equipment required for carrying out work as per Ministry's specification and direction of NHIDCL.																																			

Note: The bidder must upload scanned copy of the documentary evidence in support of his owning/leased/ rented of the above equipment's. In case the bidder proposes to hire or take the above equipment on lease, he should, along with the lease/rent agreement, attach the proof of ownership of these equipment's with the company/ entity from whom the equipment's are proposed to be hired on lease/ rent.

(4.4)
(B) (b) (ii)

**The Number of Technical personnel, Qualifications and Experience will be as follows:
The Technical Personnel are:**

SL. No.	Personnel	Qualification	Particular Experience (minimum requirement)	No. of Persons
1	Project Manager	Degree in Civil Engineering	5 years as Project Manager on Highway, Bridge construction/Maintenance works	1
2	Site Engineer-cum-Surveyor Engineer cum Material Engineer	Degree in Civil Engineering	4 years on Highway Construction/Maintenance works	1
3	Incident cum Road Property Manager cum Route Operation Manager	Graduate from a recognized University	3 years on Highway Property Management and Maintenance	1
4	Road Safety Auditor	Road Safety Audit Certificate from appropriate approved Govt. agency	5 years experience	3 days in every 3 months
			Total	4

Note: The detailed signed and scanned CV's of the Key Technical Personnel at S. No. 1 signed by the key personnel himself, must be uploaded along with the bid. The name and educational qualification of other personnel should be given.

[9.2.1] - Pre-bid meeting shall be held on 10.07.2025.

SECTION -3

QUALIFICATION INFORMATION

SECTION -3

QUALIFICATION INFORMATION

The information to be filled in by the Bidder in this section and documents submitted in physical form will be used for the purposes of post qualification as provided for in **Clause 4** of the Instructions to Bidders. This information will not be incorporated in the Contract.

QUALIFICATION INFORMATION

1. For Individual Bidders

- 1.1 a) Year of Constitution
b) Legal status of Bidder (Proprietorship/Partnership or Pvt. Ltd. firm)
[Upload scanned copy of original]
c) Place of registration: _____
d) Principal place of business: _____
- 1.2 Power of Attorney of signatory of Bid *[Upload scanned copy and also supply Original Copy in envelope of physical form]*
- 1.3 Total value of Civil Engineering construction and/or maintenance works performed in the last three years (in Rs. Lakh).

Refer ITB **Clause 4.4 A (a)**

(Upload scanned copies of certificate from Chartered Accountant and also supply original certificate from Chartered Accountant with **UDIN No.**)

Year	Total value of work performed (Rs. Lac)
2023-24	
2022-23	
2021-22	
Total:	
Average Per Year:	

1.4 (a) Work performed as prime contractor/JV partner provided further that all other qualification criteria are satisfied (in the same name) of a similar nature during the last five years as per ITB **Clause 4.3A (b)**.

Project Name	Name of the Employer*	Description of work	Value of Contract (Rs. In Lac)	Date of issue of work order	Stipulated period of completion	Actual date of completion *	Remarks explaining reasons for delay in work Completed

Upload certificate(s) from the Employer (to be given by an officer not below the rank of Executive Engineer or equivalent or higher employed in **Govt./ Govt. undertaking and also supply original or certified copy in physical form envelope)*

Note: In case of sub-contractor—a certificate from the Executive Engineer or equivalent of the Principal Employer (*Govt./ Govt. undertaking*) should be obtained from whom an approval for subcontractor has been obtained.

1.4 (b) Information on Bid Capacity (works for which bids have been submitted and accepted and works which are yet to be completed) as on the date 7 days before the last date for bid submission (as per **Clause 4.4** of the ITB).

(i) Existing commitments and on-going works(B)

Description of work	Place & State	Contract No.	Name & Address of Employer	Value of Contract (RsCr)	Stipulated Period of Completion	Value of works* remaining to be completed (RsCr)	Escalation factor	Anticipated date of completion	Escalated value of remaining work during completion period of work for which bids are invited
1	2	3	4	5	7	8	9	10	11

* Upload certificate(s) from the Engineer(s)-in-Charge of the rank of Executive Engineer or equivalent & also supply original or certified copy of certificate in physical form envelope.

(ii) Details of works for which bid submitted and accepted (i.e. where contract signing is pending)

Description of works	Place & State	Name & Address of Employer	Date of issue of Letter of Acceptance (LOA)*	Value given in LOA	Stipulated period for completion	Value of work during completion period of work for which bids are invited
1	2	3	4	5	6	7

* Upload copy of LOA

(iii) Bid Capacity (Bidder shall calculate, mention his bid capacity and enclose the supporting calculation)

A = Rs..... Lakh (enclose the details)

N = years

B = Rs..... lakh (enclose the details)

Available bid capacity = $A \times N \times 2.5 - B$

= Rs..... lakhs

1.5 Availability of Key Equipment essential for carrying out the Works [Ref. **Clause 4.3(B)** (b) (i)]. The Bidder should list all the information requested below.

Item of Equipment	Requirement		Availability Proposals		Page No of the proof attached
	No.	Capacity	Owned/Leased rented	Age/Condition	

Note: The bidder must upload the documentary evidence in support of his owning/ leased/ rented of the above equipment. In case the bidder proposes to hire or take the above equipment on lease, he should, along with the lease/rent agreement, attach the proof of ownership of these equipment's with the company/entity from whom the equipment are proposed to be hired on lease/rent. Any conditional evidence of deployment of above equipment or inadequate proof as required for any of the equipment shall make the bid non-responsive and financial bid shall not be opened.

1.6 Qualification and Experience of Key Personnel required for administration and execution of the Contract [Ref. **Clause 4.3(B)(b)(ii)**]. Upload biographical data for technical personnel (Refer also to **Clause. 4.1(e)** of Instructions to Bidders).

(Refer also to Sub **Clause 9.1** of the General Conditions of Contract).

Position	Name	Qualification	Total Professional Experience (Years)	Experience in the proposed position (Years)

Note : The signed CVs of the Technical Personnel must be uploaded along with the bid. Non-compliance of the above or non-furnishing of the CV as above or conditional deployment of any of the above personnel or proposal to employ lesser number of personnel than above shall make the bid non-responsive and financial bid shall not be opened.

1.7 Information on litigation history in which the Bidder is involved.

Other Party	Employer	Cause of Dispute	Amount involved (Rs lakh)	Remarks showing Present Status

2. Bidders should upload the scanned copy of the following affidavits/ undertakings as per formats enclosed hereinafter and also send original copy of Affidavit/ Undertakings:-

- i) Affidavit (it should be on stamp paper attested by Notary Public)
- ii) Undertaking regarding availability of minimum cash amounting to **25%** of the value of work during implementation of the Contract towards working capital.
- iii) Undertaking that the Bids shall remain valid for the period specified in **Clause 15.1**.

AFFIDAVIT

1. I, the undersigned, do hereby certify that all the statements made in the enclosed attachments are true and correct.
2. The undersigned also hereby certifies that neither our firm M/s _____
_____ have abandoned any work in India nor any contract awarded to us for such works have been rescinded, during last five years prior to the date of this bid.
3. The undersigned hereby Authorize(s) and request(s) any bank, person, firm or corporation to furnish pertinent information deemed necessary and requested by the Employer to verify this statement or regarding our competence and general reputation.
4. The undersigned understands and agrees that further qualifying information may be requested, and agrees to furnish any such information at the request of the Employer and within the prescribed time.

(Signed by an Authorised Representative of the Firm)

Name of the Representative

Name of Firm

Date

To be notarized by Notary

UNDERTAKING

I, the undersigned do hereby undertake that our firm M/s _____ shall maintain availability of minimum cash amounting to 25% of the value of the work during implementation of the Contract towards the working capital.

(Signed by an Authorised Representative of the Firm)

Name of the Representative

Name of Firm

Date

UNDERTAKING

1 I I, the undersigned do hereby undertake that our firm M/s. _____ agree to abide by this bid for a period of _____ days after the date fixed for receiving the same and it shall be binding on us and may be accepted at any time before the expiration of that period.

(Signed by an Authorized Representative of the Firm)

Name of the Representative

Name of Firm

DATE

Appendix 1.7 [Ref. clause 4.4 B (b)(i)]

(On the letter head of the bidder)

UNDERTAKING

I, the undersigned do hereby undertake that our firm M/s..... agree to provide and will deploy required equipment as mentioned in the Appendix to ITB of the work..... (Name of the work)..... Further it is certified that the documents submitted as an evidence of availability of the key equipment's for this work as stated in the Appendix to ITB, are genuine and correct. If anything contrary to the details as submitted is found at any stage Authority would be at liberty to debar/black list my firm for an appropriate period as decided by Authority.

(Signed by an Authorised Representative of the Firm)

Name of the Representative

Name of Firm & Seal

Date

SECTION-4

**BID SECURING DECLARATION
LETTER OF ACCEPTANCE (LOA) AND AGREEMENT**

SECTION-4

FORMS OF BANK GUARANTEES LETTER OF ACCEPTANCE (LOA) AND AGREEMENT

FORM OF e-BANK GUARANTEE FOR BID SECURITY **(e-BGs Only - Entity ID of NHIDCL is AAECN7759E)**

To

Executive Director (Projects)
National Highways & Infrastructure Development Corporation Ltd.
House no. 261, Sector -06, Channi- Himmat, Jammu, 180015
Email - rojammunhidcl@gmail.com

WHEREAS _____ (Name of Bidder) (hereinafter called the Bidder) wishes to submit his Bid for herein after called "the Bid" KNOW ALL MEN by these present that we _____ (Name of Bank) of _____ (Name of country) having our registered office at _____ (hereinafter called the „Bank“) are bound unto Executive Director (Projects), National Highways & Infrastructure Development Corporation Ltd. (hereinafter called "the Employer") in the sum of the Rs. _____ (Rupees _____) *for which payment can truly be made to the said Employer. The Bank bind themselves, their successors and assigns by these present with the common seal of the Bank this day _____ of _____ and undertake to pay the amount of _____ Rs. _____ to the employer upon receipt of his first written demand without the employer having to substantiate his demand.

The conditions of this obligation are:

(i) If the Bidder withdraws his Bid during the period of Bid validity specified in the Form of Bid.

Or

(ii) If the Bidder having been notified of the acceptance of his Bid by the Employer during the period of Bid validity.

(a) fails or refuses to execute the Form of Agreement in accordance with the instructions to bidders, if required; or

(b) fails or refuses to furnish the Performance Security, in accordance with the Instruction to Bidders.

We undertake to pay to the Employer upto the above amount upon receipt of his first written demand, without the employer having to substantiate his demand, provided that in his demand the Employer will note that the amount claimed by him is due to him owing to the occurrence of any one of the above conditions, specifying the occurred condition or conditions.

This guarantee will remain in force upto and including the date 45 days beyond the validity of the bid as stated in the Instructions to Bidders or as it may be extended by the Employer, at any time prior to the closing date for submission of the Bidders Notice of which extension to the Bank is hereby waived. Any demand in respect of this guarantee should be made on the Bank on or before the date of expiry of this guarantee.

This guarantee shall also be operatable at Jammu, from whom, confirmation regarding the issue of this guarantee or extension/ renewal thereof shall be made available on demand. In the contingency of this

guarantee being invoked and payment there under claimed, the said branch shall accept such invocation letter and make payment of amounts so demanded under the said invocation.
 Notwithstanding anything contained herein before, our liability under this guarantee is restricted to Rs..... (Rs._____in words) and the guarantee shall remain valid till _____. Unless a claim or a demand in writing is served upon us on or before _____ all our liability under this guarantee shall cease.

e-Bank Guarantee has been sent to authority's bank through SFMS gateway as per the details below: -

S.No.	Particulars	Details
1	Name of Beneficiary	National Highways & Infrastructure Development Corporation Limited
2	Beneficiary Bank Account No.	76411010002171
3	Beneficiary Bank Branch	IFSC CNRB0002975
4	Beneficiary Bank Branch Name	Canara Bank, Channi-Himmat
5	Beneficiary Bank Address	Canara Bank, Channi-Himmat, Jammu, J&K, 180015

SIGNATURE OF AUTHORISED REPRESENTATIVE OF THE BANK _____

NAME AND DESIGNATION _____

EMPLOYEE CODE NUMBER SEAL OF THE BANK _____

SIGNATURE OF THE WITNESS (IF THIS IS TO BE WITNESSED AS PER BANK'S POLICY)

NAME OF THE WITNESS _____

ADDRESS OF THE WITNESS _____

Note- For further details and step by step process regarding e-BG and online payment, NHIDCL Office Order dated 22nd March 2023 may be referred, which is attached as Appendix-A.

**FORM OF e-BANK GUARANTEE FOR PERFORMANCE SECURITY/
ADDITIONAL PERFORMANCE SECURITY
(e-BGs Only - Entity ID of NHIDCL is AAECN7759E)**

Contract Package No: [NHIDCL/RO(JMU)/NH-244/M&R/B-K/308/2025-26]

To

**Executive Director (Projects)
National Highways & Infrastructure Development Corporation Ltd.
House no. 261, Sector -06, Channi- Himmat, Jammu, 180015
Email - rojammunhidcl@gmail.com**

WHEREAS..... (name and address of contractor) hereinafter called “the contractor” has undertaken, in pursuance of Letter of Acceptance No. Dated..... to execute..... (name of Contract and brief description of Works) (hereinafter called “the contract”).

AND WHEREAS it has been stipulated by you in the said contract that the Contractor shall furnish you with a Bank Guarantee for the sum specified therein as security for compliance with his obligations in accordance with the Contract;

AND WHEREAS we have agreed to give the Contractor such a Bank Guarantee:

NOW THEREOF we hereby affirm that we are the guarantor and responsible to you on behalf of the Contractor, up to a total of Rs..... (amount of guarantee) (Rupees... (in words), , and we undertake to pay you, upon your first written demand and without cavil or argument, any sum or sums within the limits of..... (amount of guarantee) as aforesaid without your needing to prove or to show grounds or reasons for your demand for the sum specified therein.

We hereby waive the necessity of your demanding the said debt from the Contractor before presenting us with the demand.

We further agree that no change or addition to or other modification of the terms of the contract or of the works to be performed there under or of any of the contract documents which may be made between you and the Contractor shall in any way release us from any liability under this guarantee, and we hereby waive notice of any such change, addition or modification.

This guarantee shall be valid until 60 days from the date of expiry of the Defects Liability Period .

This guarantee shall also be operatable at Jammu, from whom, confirmation regarding the issue of this guarantee or extension/ renewal thereof shall be made available on demand. In the contingency of this guarantee being invoked and payment there under claimed, the said branch shall accept such invocation letter and make payment of amounts so demanded under the said invocation.

Notwithstanding anything contained herein before, our liability under this guarantee is restricted to Rs. (Rs. _____ in words) and the guarantee shall remain valid till Unless a claim or a demand in writing is served upon us on or before _____ all our liability under this guarantee shall cease.

Signature and seal of the Guarantor with Name, Designation, Employee Code Number & Telephone

Number.....

Name of the Issuing Bank/ BranchName of the Controlling Branch/Bank.....

Address & Telephone Number.....Address & Telephone Number.....

Date.....

In the presence of (if this is to be witnessed as per bank's policy).....

1.....
(Name, Address & Occupation)

2.....
(Name, Address & Occupation)

An amount shall be inserted by the Guarantor, representing the percentage of the Contract Price specified in the Contract including additional security for unbalance bids, if any and denominated in Indian Rupees.

Note- For further details and step by step process regarding e-BG and online payment, NHIDCL Office Order dated 22nd March 2023 may be referred, which is attached as Appendix-A.

FORM OF LETTER OF APPLICATION

To,

Executive Director (Projects)

National Highways & Infrastructure Development Corporation Ltd.

House no. 261, Sector -06, Channi- Himmat, Jammu, 180015

Email – rojammunhidcl@gmail.com

DESCRIPTION OF WORKS: Restoration & Repair of Batote Khellani road (existing NH-244) by way of Laying of Bituminous Macadam & Bituminous Concrete, Breast/wall, Pucca & Kachha Drain, Culverts, Road Marking & Road Transverse Strips, Delineators, Flickering Cat eyes etc., from Km 0.000 to Km 45.000 on Batote-Khellani stretch of existing NH-244 in the UT of Jammu & Kashmir for FY 2025-26

Dear Sir,

Having examined the Bid Document, Instructions to Bidders, Qualification Information, Scope of works, etc. for the subject work we hereby submit our bid for the subject work.

It is certified that the information furnished in this document is true and correct. The proposal is unconditional and unqualified. We undersigned accept that the Employer reserves the right to reject any or all applications without assigning any reason.

Thanking you,

Yours faithfully,

(Authorized Signatory)

For and on behalf of M/s_____

FORM OF LETTER OF ACCEPTANCE

No.....

Dated.....

To

M/s.....

Sub.:.....**Name of Work**.....

Sir,

Based on your bid submitted on ...in compliance of bidding document of [the Employer] for execution of the works of, it is hereby notified that your bid for a Contract Price of **Rs..... (Rupees in words.....)** has been accepted for and on behalf of [the Employer]

You are here by requested to furnish Performance Security plus additional security in the form detailed in **Clause 32.2** of ITB for an amount equivalent to **Rs..... (Rupees in words.....)** within 10 days as per provisions of **Clause 32.1** of ITB of the bid document and sign the contract agreement failing which the actions as stipulated in **Clause-32.3** of ITB shall be taken.

Thanking you,

Yours faithfully,

(.....)

Employer

FORM OF AGREEMENT

AGREEMENT

This agreement made the _____ day of _____ between the
----- (hereinafter called "the Employer" of the one part and _____
(hereinafter called "the Contractor") of the other part.

AND WHEREAS the Employer invited bids from eligible bidders for the execution of certain works, viz **"Restoration & Repair of Batote Khellani road (existing NH-244) by way of Laying of Bituminous Macadam & Bituminous Concrete, Breast/wall, Pucca & Kachha Drain, Culverts, Road Marking & Road Transverse Strips, Delineators, Flickering Cat eyes etc., from Km 0.000 to Km 45.000 on Batote-Khellani stretch of existing NH-244 in the UT of Jammu & Kashmir for FY 2025-26** AND WHEREAS pursuant to the bid submitted by the Contractor, vide _____ (herein after referred to as the "BID" or "OFFER") for the execution of works, the Employer by his letter of acceptance dated _____ accepted the offer submitted by the Contractor for the execution and completion of such works and remedying of any defects there on, on terms and conditions in accordance with the documents listed in **Para2** below.

AND WHEREAS the Contractor by a deed of undertaking dated _____ has agreed to abide by all the terms of the bid, including but not limited to the amount quoted for the execution of Contract, as stated in the bid, and also to comply with such terms and conditions as may be required from time to time.

AND WHEREAS the Contractor has agreed to undertake such works and has furnished a Performance Security pursuant to **Clause32** of ITB (**Section-2**).

NOW THIS AGREEMENT WITNESSETH as follows:

1. In this agreement, words and expressions shall have the same meaning as are respectively assigned to them in the conditions of contract hereinafter referred to;
2. The following documents shall be deemed to form and be read and construed as part of this agreement viz.
 - a) Agreement;
 - b) Letter of Acceptance;
 - c) Contractor's Bid;
 - d) Contract Data;
 - e) General Conditions of Contract;
 - f) Addendum to General Conditions of Contract;
 - g) Road Maintenance Standards and Specifications for Road Maintenance Works;
 - h) Drawings, if any;
 - i) Bill of Quantities; and
 - j) Any other document listed in the Contract Data.

3. The foregoing documents shall be construed as complementary and mutually explanatory one with another. Should any ambiguity or discrepancy be noted, then the order of precedence of these documents shall be subject to the order as listed above and interpreted in the above order of priority.
4. In consideration of the payments to be made by the Employer to the Contractor as hereinafter mentioned, the Contractor hereby covenants with the Employer to execute and complete the works and remedy any defects therein in conformity in all respects with the provisions of the contract.
5. The Employer hereby covenants to pay the Contractor in consideration of the execution and completion of the works and remedying of defects therein, the Contract Price or such other sum as may become payable under the provisions of the contract at the times and in the manner prescribed by the contract.

IN WITNESS WHERE OF the parties here to have caused this agreement to be executed the day and year above written. Signed, sealed and delivered by the said Employer through his Authorized Representative and the said Contractor through his Power of Attorney holder.

Binding Signature of Employer _____ **Binding Signature of Contractor** _____

For and on behalf of _____ For and on behalf of M/s-----

In the presence of

1. Name:

Address:

2. Name:

Address:

In the Presence of

1.Name:

Address:

2.Name:

Address:

SECTION -5
GENERAL CONDITIONS OF CONTRACT (GCC)

SECTION 5

GENERAL CONDITIONS OF CONTRACT (GCC)

TABLE OF CLAUSES

A. General

1. Definitions
2. Interpretation
3. Language and Law
4. Engineer's Decisions
5. Delegation
6. Communications
7. Subcontracting
8. Other Contractors
9. Personnel and Equipment
10. Employer's and Contractor's Risks
11. Employer's Risks
12. Contractor's Risks
13. Insurance
14. Site Investigation Reports
15. Queries about the Contract Data
16. Contractor to Construct the Works
17. The Works to be completed by the Intended Completion Date
18. Approval by the Engineer
19. Site Regulations and Safety
20. Discoveries
21. Possession of the Site
22. Access to the Site
23. Instructions
24. Procedure for Dispute Resolution

B. Time Control

25. Programme
26. Extension of the Intended Completion Date
27. Delays ordered by the Engineer
28. Management Meetings

C. Quality Control

29. Identifying Defects
30. Tests

31. Correction of Defects noticed during the Defects Liability Period

32. Uncorrected Defects

D. Cost Control

33. Bill of Quantities
34. Changes in the Quantities
35. Variations
36. Payments for Variations
37. Cash Flow Forecasts
38. Payment Certificates
39. Payments
40. Compensation Events
41. Taxes and Currencies for Payments
42. Security Deposit/ Retention Money
43. Liquidated Damages
44. Advance Payments
45. Performance Security
46. Cost of Repairs

E. Finishing the Contract

47. Completion
48. Taking Over
49. Final Account
50. Operation and Maintenance Manual
51. Termination
52. Payment upon Termination
53. Property
54. Release from Performance

F. Other Conditions of Contract

55. Labour
56. Compliance with Labour Regulations
57. Drawings and Photographs of the Works
58. The Apprentices Act, 1961

A.GENERAL

1. Definitions

1.1 Terms which are defined in the Contract Data but not defined in the Conditions of Contract keep their defined meanings. Capital initials are used to identify defined terms.

Bill of Quantities means the priced and completed Bill of Quantities forming part of the Contractor's Bid.

Certificate of Completion is the Certificate issued by the Engineer upon completion of works or parts thereof as applicable in accordance with **Clause47**.

Compensation Events are those defined in **Clause40**.

Contract is the Contract between the Employer and the Contractor to maintain the road assets and to execute, complete, and maintain the Works. It consists of the documents listed in **Clause2.3**.

Contract Data defines the documents and other information, which comprise the Contract.

Contractor is a person or corporate body whose Bid to carry out the Road Maintenance Works and Activities has been accepted by the Employer.

Contractor's Bid is the completed Bidding Document submitted by the Contractor to the Employer.

Contract Price is the price stated in the Letter of Acceptance and thereafter as adjusted in accordance with the provisions of the Contract.

Days are calendar days; months are calendar months.

Defect is any part of the Maintenance Works and Activities not completed in accordance with the Contract Specifications.

Defects Liability Certificate is the certificate issued by the Engineer, after the Defects Liability Period has ended and upon correction of Defects by the Contractor.

Defects Liability Period means the period so stipulated in the Contract Data, calculated from the Completion Date, during which the Contractor remains responsible for the rectification of any defect in the Works he has undertaken.

Employer is the party as defined in the Contract Data, who employs the Contractor to carry out the Works. The Employer may delegate any or all functions to a person or body nominated by him for specified functions.

Engineer is the person named in the Contract Data (or any other competent person appointed by the Employer and notified to the Contractor, to act in replacement of the Engineer) who is responsible for supervising the execution of the Works and administering the Contract on behalf of the Employer.

Equipment is the Contractor's machinery and vehicles brought temporarily to the Site to execute the Maintenance Works and Activities.

Intended Completion Date is the date, as given in contract data, on which it is intended that the Contractor shall complete the Works as per scope under the contract. The intended Completion Date may be revised only by the Engineer by issuing an Extension of Time after approval from the Employer.

Letter of Acceptance means the formal acceptance of the Bid by the Employer.

Materials are all supplies, including consumables, used by the Contractor for incorporation in the Maintenance Works and Activities.

Maximum Response Time means the maximum permissible time within which remedial action must be completed prior to a defect exceeding the permissible tolerance. Maximum Response Time commences from the time of earliest detection of the defect by (i) observation of the defect by the Contractor, or (ii) notification of the defect by the Engineer, or (iii) intimation of the defect by a road user.

Notice to Proceed means the notice issued by the Employer to the Contractor to proceed with the work after signing of the contract pursuant to **Clause 32.1** of ITB.

Permissible Tolerance means the maximum permissible amount or quantity of a defect in road-asset condition that will not be exceeded at any time. If any defect exceeds the permissible tolerance, it shall be treated as “non-compliance” and the Contractor shall be paid in accordance with the relevant provisions in this contract.

Project Manager is a person appointed by the Contractor who is in charge of managing all activities of the Contract or under the Contract. He is also the Contractor’s Representative for the purpose of this Contract.

Road means the Road or package of roads in network or scattered for which the Maintenance Works and Activities are to be carried out under the Contract.

“**Road Assets**” include the following:

- i) Main carriage way with shoulders (paved and/or earthen), medians, slip roads, service roads;
- ii) Road embankment including slopes, protection works, kerbs and chute drains;
- iii) Road way in cutting including slopes protection works, drains;
- iv) Culverts, Bridges, Over/ Underpasses, retaining walls, Guide bunds, Floor protection works;
- v) Road signs, road markings, road delineators, guardrails, safety barriers, railings, fencings, parapets, kilometer stones ,200m stones, road boundary stones;
- vi) All types of drains, trees, plantations and erosion control measures;
- vii) Road land;
- viii) Any other project facility or asset forming integral part of the road(s).

Road Maintenance Standards is the collective term for parameters which define the condition in which the road assets are required to be maintained and other requirements regarding safety and quality of works to be complied with by the Contractor.

Road Maintenance Works and Activities to be carried out by Contractor shall include:

Maintenance of the road incident management specified in the BOQ and executing other items of road maintenance works as ordered by the Engineer.

Rectification Standard

The Contractor shall maintain the Specific parts of the road aspects as specified in BOQ or as ordered by Engineer in charge and ensure road users safety and comfort. The maintenance activities shall be so planned that the defects are repaired well before they reach maximum condition as per the permissible tolerance.

Site is the area defined as such in the Contract Data, where maintenance works are to be executed.

Specifications mean the Specifications of the Maintenance Works including the Road Maintenance Standards as per the Contract.

Start Date is given in the Contract Data. It is the date when the Contractor shall commence execution of the Works.

Service Level means the defined condition in which the road assets are to be maintained by the Contractor.

Sub-Contractor is a person or corporate body who has a Contract with the Contractor to carry out a work under the Contract, which includes part of the agreed scope of works at the Site.

Temporary Works are works designed, constructed, installed and removed by the Contract or that are needed for Works and Activities.

Time for Completion means the duration for completing the execution of maintenance works and passing the tests on completion of the Works or any Section or part there of as stated in the Contract Data or as extended by the Engineer by issuing an Extension of Time after the approval from the Employer.

Variation is an instruction given by the Engineer in writing which varies the scope of Maintenance Works.

Work Order is an order issued by the Engineer to the Contract or for execution of certain works, specifying the time limits which may be in variance with the approved programme or in variation to the scope of work depending upon the site requirement.

2. Interpretation

2.1 In interpreting these Conditions of Contract, singular also means plural, male also means female or neuter and the other way around. Headings have no significance. Words have their normal meaning under the language of the Contract Unless specifically defined. The Engineer will provide instructions clarifying queries about these Conditions of Contract.

2.2 If part completion is specified in the Contract Data, references in the Conditions of Contract to the Works, the Completion Date and the Intended Completion Date apply to any part of the Works (other than references to the Completion Date and Intended Completion Date for the whole of Works).

2.3 The following documents shall be deemed to form and be read and construed as part of the Contract. In case any ambiguity or discrepancy is noted, then the Contract shall be interpreted in the following order of priority:

- i) Agreement;
- ii) Notice to Proceed with the Work;
- iii) Letter of Acceptance;
- iv) Contractor's Bid;
- v) Contract Data;
- vi) General Conditions of Contract;
- vii) Road Maintenance Standards and Specifications for Road Maintenance Works, Part I and Part II;
- viii) Priced Bill of Quantities; and
- ix) Any other documents listed in the Contract Data.

3. Language and Law

3.1 The language of the Contract shall be in English and the law governing the Contract as given in Contract Data.

4. Engineer's Decisions

4.1 The Employer shall designate and notify to the Contractor in writing the name of the Engineer.

4.2 Except where otherwise specifically stated, the Engineer will decide contractual matters between the Employer and the Contractor in the role representing the Employer. The Engineer shall have no authority to relieve the Contractor of any of his obligations under the Contract.

5. Delegation

5.1 The Engineer, duly informing the Employer, may delegate any of his duties and responsibilities to other people, after notifying the Contractor and may cancel any delegation under intimation to the Contractor.

6. Communications

6.1 Communications between parties that are referred to in the Conditions shall be effective only when in writing. A notice shall be effective only when it is delivered as per Indian Law.

7. Sub contracting

DELETED.

8. Other Contractors

8.1 The Contractor shall cooperate and share the Site with other Contractors, public authorities, utilities, and the Employer between the dates given in the Schedule of Other Contractors, as referred to in the Contract Data. The Contractor shall also provide facilities and services for them as described in the Schedule. The Employer may modify the Schedule of Other Contractors and shall notify the Contractor of any such modification. The Contractor shall cooperate in such situations as well.

8.2 The Contractor should take up the works in convenient reaches as decided by the Engineer to ensure that there is least hindrance to the smooth flow of traffic including movement of vehicles and equipment of other Contractors till the completion of Works.

9. Personnel and Equipment

9.1 The Contractor shall employ the technical personnel named in the Contract Data or other technical persons approved by the Engineer. The Engineer will approve any proposed replacement of technical personnel only if the irrelevant qualifications and abilities are substantially equal to or better than those of the personnel stated in the Contract Data. If the personnel stated in the Contract Data are not deployed on site by the Contractor within 15days of issue of notice to proceed with the work, a penalty of **5000/-** per day per person shall be levied for next 30days, beyond which it shall be treated as a breach of Contract and action will be taken as per **Clause51**.

9.2 The Contractor shall use the equipment identified in the bid along with competent Operators and adequate stock of spares for smooth operations.

9.3 If the Engineer asks the Contractor to remove a person who is a member of the Contractor's staff or work force, stating the reasons, the Contractor shall ensure that the person leaves the Site within seven days and has no further connection with the Works under the Contract.

9.4 The Contractor shall establish, within his own organizational structure, a planning unit, staffed with suitably qualified personnel. The team will be headed by a Project Manager who will be assisted by his representatives, i.e. Site Manager and Manager, Planning. The task of this unit will be:

9.4.1 To plan, and to verify continuously the degree of compliance by the Contractor with the specified Road Maintenance Standards and report the same to the Engineer in the format acceptable to the Engineer.

9.4.2 To maintain and update the road condition inventory regularly.

9.4.3 To assist the Engineer in verification of the compliance.

9.5 The Contractor's planning unit mentioned under **Sub-clause 9.4** shall report the level of compliance with the required Service Levels in the standard formats acceptable to the Engineer.

10. Employer's and Contractor's Risks

10.1 The Employer carries the risks which this Contract states are Employer's risks, and the Contractor carries the risks which this Contract states are Contractor's risks.

11. Employer's Risks

11.1 The Employer is responsible for the expected risks which are (a) in so far as they directly affect the execution of the Maintenance Works and Activities included in the Contract, the risks of war, hostilities, invasion, act of foreign enemies, rebellion, revolution, insurrection or military or usurped power, civil war, riot, commotion or disorder (unless restricted to the Contractor's employees), natural calamities and contamination from any nuclear fuel or nuclear waste or radioactive toxic, explosive.

12. Contractor's Risks

12.1 All risks of loss of or damage to physical property and of personal injury and death, which arise during and in consequence of the performance of the Contract other than the excepted risks, referred to in **Clause 11.1**, are the risks of the Contractor.

13. Insurance

13.1 The Contractor at his cost shall provide, in the joint names of the Employer and the Contractor, insurance cover from the Start Date to the completion of defect liability period, in that amounts and deductibles stated in the Contract Data for the following events which are due to the Contractor's risks:

- a) Loss of or damage to the Works and Materials
- b) Loss of or damage to Equipment
- c) Loss of or damage to property (except the Works Materials and Equipment) in connection with the Contract
- d) Third Party Liability Insurance
- e) Auto mobile Liability Insurance
- f) Workers' Compensation
- g) Employer's Liability
- h) Other Insurances

13.2 Insurance policies and certificates for insurance shall be delivered by the Contractor to the Engineer for the Engineer's approval before the Start Date. All such insurance shall provide for compensation to be payable in Indian Rupees to rectify the loss or damage incurred.

13.3 If the Contractor does not provide any of the policies and certificates required, the Employer may affect the insurance which the Contractor should have provided and recover the premiums the Employer had paid from payments otherwise due to the Contractor or, if no payment is due, the payment of the premiums shall be a debt due from the Contractor.

13.4 Alterations to the terms of insurance shall not be made without the approval of the Engineer.

13.5 Both parties shall comply with any conditions of the insurance policies. The Contractor shall ensure that wherever applicable, its Sub-Contractor(s) shall take out and maintain in effect adequate insurance policies for their personnel and vehicles and for works executed by them under the Contract unless such Sub-Contractor(s) is/ are covered by the policies taken out by the Contractor.

14. Site Investigation Reports

14.1 The Contractor, in preparing the Bid, may rely at his own risks and liability on any Site Investigation Reports referred to in the Contract Data, supplemented by any other information available to him.

15. Queries about the Contract Data

15.1 The authorized representative of the Employer as stated in the Contract data will Clarify queries on the Contract Data.

16. Contract or to Construct the Works

16.1 The Contractor's obligations cover the carrying out of all Maintenance Works and Activities as defined in the Contract for keeping the roads in accordance with the Road Maintenance Standards.

The Contractor shall construct, install and maintain the Works in accordance with the Specifications and Drawings.

17. The Works to be completed by the Intended Completion Date

17.1 The Contractor may commence execution of the Maintenance Works and Activities on the Start Date and shall carry out the Works in accordance with the Programme submitted by the Contractor, as updated with the approval of the Engineer, and complete them by the Intended Completion Date.

18. Approval by the Engineer

18.1 The Contractor shall prepare/ propose the Maintenance Manuals as per relevant applicable Standards and Specifications and existing policies/ guidelines/ practices and get the same approved from the Engineer/ Employer.

18.2 The Contractor shall submit Specifications and Drawings showing the proposed Temporary Works to the Engineer, who is to approve them if they comply with Specifications and drawings.

18.3 The Contractor shall be responsible for design of Temporary Works.

18.4 The Engineer's approval shall not alter the Contractor's responsibility for design of the Temporary Works.

18.5 The Contractor shall obtain approval of third parties to the design of Temporary Works by Engineer.

18.6 All Drawings prepared by the Contractor for the execution of temporary or permanent Works, are subject to prior approval by the Engineer before their use.

19. Site Regulations and Safety

19.1 The Contractor shall be responsible for the safety of all activities on the Site, including arrangements for smooth flow of traffic at his own cost as per guidelines of the IRC/ Ministry of Road Transport & Highways. He shall provide proper barricading, diversion boards, etc. He shall be fully responsible for the safety of workers and staff at site and provide safety helmets, reflective jackets and other PPE to the workers, inspecting officers and supervisors.

20. Discoveries

20.1 Anything of historical or other interest or of significant value unexpectedly discovered on the Site is the property of the Employer. The Contractor shall notify the Engineer of such discoveries and carryout the Engineer's instructions for dealing with them.

21. Possession of the Site

21.1 The Employer shall give possession of all parts of the Site to the Contractor on or before the start date of the Contract.

22. Access to the Site

22.1 The Contractor shall allow access to the Site and to any place where work in connection with the Contract is being carried out, or is intended to be carried out to the Engineer and any person/ persons/ agency authorized by:

- a) The Engineer
- b) The Employer

23. Instructions

23.1 The Contractor shall carry out all instructions of the Engineer pertaining to the maintenance works which comply with the applicable laws where the Site is located.

23.2 The Contractor shall permit the Engineer/ Employer to inspect the Contractor's contemporary records in respect of invoice of bitumen, cement, aggregates and steel, if so desired by the Engineer.

24. Procedure for Dispute Resolution

24.1 Arbitration

The procedure for arbitration will be as follows:

- i) In case of Dispute or difference arising between the Employer and the Contractor relating to any matter arising out of or connected with this contract, such disputes or differences shall be settled in accordance with the Arbitration and Conciliation Act, 1996 as amended vide Act of 2015. The Arbitral Tribunal shall consist of sole Arbitrator from the panel of three Arbitrators proposed by the Employer and choice of selecting one given to the Contractor. Contractor shall select one out of the three names of Arbitrators given to him within 30 days failing which the Employer shall nominate the Arbitrator out of the panel of three Arbitrators. In case the Contractor objects to the Arbitrator selected by the Employer, the Employer shall refer selection of Arbitrator to the Indian Roads Congress for nominating the Arbitrator for the dispute and both parties agree that the Arbitrator so selected by IRC shall decide the dispute. Indian Roads Congress shall try to appoint Arbitrator preferably from the state where the project is located or otherwise from adjoining States.
- ii) Arbitration proceedings shall be held at [Name of Place], India, and the language of the arbitration proceedings and that of all documents and communications between the parties shall be English.
- iii) The decision of the Arbitrator shall be final and binding upon both parties. The cost and expenses of Arbitration proceedings will be paid as determined by the Arbitral Tribunal. However, the expenses incurred by each party in connection with the preparation, presentation, etc. of its proceedings shall be borne by each party itself. The fees and expenses of the Arbitrator shall be shared equally by both the parties.
- iv) Performance under the contract shall continue during the Arbitration proceedings and payments due to the Contractor by the Employer shall not be withheld, unless they are the subject matter of arbitration proceedings.

B. TIME CONTROL

25. Programme

25.1 The Contractor shall submit to the Engineer for approval a programme within period specified in the contract data showing the general methods, arrangements, order, and timing for all the maintenance works and activities.

25.2 The Engineer may issue the work order in stages specifying the time limit for the same as and when required except the performance-based maintenance items.

25.3 An update of the Programme shall be a programme showing the actual progress achieved on each activity and the effect of progress achieved on the timing of the remaining Works, including any changes to the sequence of activities.

25.4 The Contractor shall submit to the Engineer for approval an updated Programme at intervals. If the Contractor does not submit an updated Programme within this period, the Engineer may with hold the amount stated in the Contract Data from the next payment certificate and continue to with hold this amount until the next payment after the date on which the overdue Programme has been submitted.

25.5 The Engineer's approval of the Programme shall not alter the Contractor's obligations. The Contractor may revise the Programme and submit it to the Engineer again at any time. A revised Programme shall show the effect of Variations and Compensation Events.

26. Extension of the Intended Completion Date

26.1 The Engineer shall extend the Intended Completion Date only after approval of the Employer if a Compensation Event occurs or a Variation is issued which makes it impossible for Completion to be achieved by the Intended Completion Date without the Contractor taking steps to accelerate the remaining Works, which would cause the Contractor to incur additional cost.

26.2 The Engineer, within 14 days of receiving full justification from the Contractor for extension of Intended Completion Date, will refer to the Employer his recommendation. The Employer shall, in not more than 21days from the date of receipt of Engineer's recommendation, communicate to the Engineer the acceptance or otherwise. The Engineer shall convey the decision of the Employer to the Contractor.

27. Delays Ordered by the Engineer

27.1 The Engineer may instruct the Contractor to delay the start or progress of any activity within the Works. Delay/delays totaling more than 30 days will require prior written approval of the Employer.

28. Management Meetings

28.1 The Engineer may require the Contractor to attend a management meeting. The business of a management meeting shall be to review the plans and progress for the Maintenance Works.

28.2 The Engineer shall record the business of management meetings and provide copies of the record to those attending the meeting. The responsibility of the parties for actions to be taken shall be decided by the Engineer either during the management meeting or after the management meeting and to be intimated in writing to all those who attended the meeting.

C. QUALITY CONTROL

29. Identifying Defects

29.1 The Engineer shall check the Contractor's work and notify the Contractor of any Defects those are found. Such checking shall not affect the Contractor's responsibilities. The Engineer may instruct the Contractor to uncover and test any work that the Engineer considers may have a Defect.

30. Tests

30.1 The Contractor shall setup a field laboratory within period stated in contract data and be solely responsible for:

- a) Carrying out the mandatory tests prescribed in Technical Specifications and
- b) For the correctness of test/ procedures, whether preformed in his laboratory or elsewhere.

30.2 If the Engineer instructs the Contractor to carry out a test not specified in the Specifications to check whether any work has a Defect and the test shows that it does, the Contractor shall pay for the testing charges and for any number of samples. Otherwise, the Employer shall pay for the testing charges.

30.3 The Contractor shall carry out all required field test of construction material as per clause 900 of MoRT&H specification and prevailing guidelines of Road and Building Department GoG. The minimum 10% of total required material testing shall be carried out in Government Testing Laboratory (i.e. GERI) at EPC Contractor's cost. In addition to the minimum 10% of total required material testing shall be carried out in Government approved NABL accredited Testing Laboratory at EPC Contractor's cost.

31. Correction of Defects noticed during the Defects Liability Period

31.1 The works carried out shall be of very high standard, requiring no major repairs on the road for at least, during defects liability period, after the date of completion of works.

31.2 If any defects including shrinkage, cracks, and other faults appear in the works within the period specified here under after issue of "Taking over" certificate, the Engineer shall give notice to the Contractor of any defects before the end of the Defects Liability Period. The Defects Liability Period shall be extended for as long as the defects remain to be corrected.

31.3 Every time notice of a defect is given, the Contractor shall correct the notified defect at his own cost within the length of time specified in the Engineer's notice.

31.4 The Defects Liability Period is not applicable for works of routine maintenance such as pot holes/ patch repairs/ ruts repairs/ cleaning and clearing, etc. under performance based BOQ item.

However, for other specific items of works (if any), got executed as ordered by Engineer (if any), the Defects Liability Period shall be **12 months**, counted from the Date of Completion stated in the Certificate of Completion issued in pursuance of Clause 47.

31.5 If during the Defects Liability Period any defect is found in the design, engineering, materials and workmanship of the Works and Services executed by the Contractor, then the Contractor shall promptly, in consultation and agreement with the Engineer, appropriately remedy such defects at its cost, or repair, replace or otherwise make good (as the Contractor shall, at its discretion, determine) such defects as well as any damage to the Road caused by such defects.

31.6 The Contractor's obligations under this Clause 31 shall not apply to:

- a) any material that is supplied by the Employer, and normally consumed in maintenance, or have a normal life shorter than the Defects Liability Period stated here in;
- b) any design, Specification or other data, supplied or specified by or on behalf of the Employer or any matter for which the Contractor has disclaimed responsibility here in;

31.7 The Employer shall offer the Contractor all reasonable opportunity to inspect the defect(s) Noticed, as well as provide all necessary access to the Facilities and the Site to enable him to perform his obligations under this **Clause31**.

The Contractor may remove from the Site any Plant and Equipment or any part of the Facilities that are defective, if the nature of the defect, and/or any damage to the Facilities caused by the defect, is such that repairs cannot be expeditiously carried out at the Site.

32. Uncorrected Defects

32.1 If the Contractor fails to correct a Defect, to the satisfaction of the Engineer, within the time specified in the Engineer's notice, the Engineer will assess the cost of having the Defect corrected. The Contractor will pay to the Employer this amount or the Engineer may deduct such amount from any sums due to the Contractor, on correction of the Defect together with **20percent** additional costs as the damages.

32.2 In case of any non-compliance/delayed compliance of maintenance standards, the damages/reduction in payment shall be applicable as provided under road Maintenance Standards Part -I.

D. COST CONTROL

33. Bill of Quantities

33.1 The Bill of Quantities shall contain the description of items, units, rates and amount.

33.2 The Bill of Quantities is used to calculate the Contract Price. The Contractor is paid for the quantity of the work done at the rates given in the Bill of Quantities with accepted/ awarded tender premium for each item for the work executed.

The accepted/ awarded tender premium above/ below the grand total of Project cost as per BOQ shall be applicable for individual item of work to determine payable amount to Contractor subject to contractual provisions.

34. Changes in the Quantities

34.1 The final quantity of the work done may differ from the quantity given in the Bill of Quantities. The payment shall be made for the quantities executed. Provided that the items for which lump sum rates have been quoted shall not be measured and the payments for such items not exceeding the quoted lump sum amount shall be made to the Contractor subject to meeting the specified maintenance requirements by the

Contractor in accordance with the Agreement. It is agreed, beyond doubt, by the Contractor that no claims shall be entertained by the Engineer/ Employer on account of reduction to any extent, due to budgetary constraints, in quantities of measurable items.

35. Variations

35.1 The Engineer may order Variations, with the prior approval of the Employer, he considers necessary or advisable during the progress of the Works. Such Variations shall form part of the Contract and the Contractor shall execute the varied works. Oral orders of the Engineer for Variations, unless followed by written confirmation, shall not be taken into account.

36. Payments for Variations

36.1 If rates for Variation items are specified in the Bill of Quantities, the Contractor shall carry out such work at the same rate.

36.2 If the rates for Variation are not specified in the Bill of Quantities, the Engineer shall derive the rate from similar items in the Bill of Quantities.

36.3 If the rate for Variation item cannot be determined in the manner specified in **Clause 36.1** or **36.2**, the Contractor shall, within 14 days of the issue of order of Variation work, inform the Engineer the rate which he proposes to claim, supported by analysis of the rates. The Engineer shall assess the quotation and determine the rate based on prevailing market rates within one month of the submission of the claim by the Contractor and approval from the Employer shall be taken. As far as possible, the rate analysis shall be based on the Standard Data Book and the current Schedule of Rates of the district public works division. The decision of the Employer on the rate so determined shall be final and binding on the Contractor.

37. Cash Flow Forecasts

37.1 When the Programme is updated, the Contractor shall provide the Engineer with an updated cash flow forecast.

38. Payment Certificates

38.1 The Contractor shall submit to the Engineer monthly statements of the value of the work executed less the cumulative amount certified previously, supported with detailed measurement of the items of work executed.

38.2 The Engineer shall check the Contractor's monthly statement within 14 days and certify the amount to be paid to the Contract or after taking in to account any credit or debit for the month in question.

38.3 The value of work executed shall be determined, based on measurements by the Engineer.

38.4 The value of work executed shall comprise the value of the quantities of the items in the Bill of Quantities completed.

38.5 The value of work executed shall also include the valuation of Variations and Compensation Events.

38.6 The Engineer/ Employer may exclude any item certified in a previous certificate or reduce the proportion of any item previously certified in any certificate in the light of latest information.

38.7 The final bill shall be submitted by the Contractor within one month of the actual date of

completion of the work; otherwise the Engineer's certificate of the measurement and of the total amount payable for work accordingly shall be final and payment made accordingly within a period of sixty days as far as possible.

39. Payments

39.1 Payments shall be adjusted for deductions for advance payments, security deposit, other recoveries in terms of the Contract and taxes at source, as applicable under the law. The Employer shall pay the Contract or the amounts the Engineer had certified, within 28 days of the date of each certificate.

39.2 The authorized representative of the Employer shall make the payment certified by the Engineer.

39.3 Items of the Works for which no rate or price has been entered in the Bill of Quantities, will not be paid for by the Employer and shall be deemed to be covered by other rates and prices in the Contract.

40. Compensation Events

40.1 The following shall be Compensation Event unless they are caused by the Contractor:

- a) The Engineer orders a delay or delays exceeding a total of 30 days;
- b) The effects on the Contract or of any of the Employer's Risks.

40.2 If a Compensation Event would prevent the Works being completed before the Intended Completion Date, the Intended Completion Date shall be extended. The Engineer shall decide whether and by how much the Intended Completion Date shall be extended after approval of the Employer.

40.3 The Contractor shall not be entitled to compensation to the extent that the Employer's interests are adversely affected by the Contractor not having given early warning or not having cooperated with the Engineer/ Employer.

41. Taxes and Currencies for Payments

41.1 The rates quoted by the Contractor shall be deemed to be inclusive of levies, duties, royalties, cess, toll, and other taxes of Central and State Governments, local bodies and authorities that the Contractor will have to pay for the performance of this Contract however it is exclusive of GST. The Employer will perform such duties in regard to the deduction of such taxes at source as per applicable law. The GST shall be reimbursed (if applicable) subject to production of proof of such payment by the contractor (proof should contain name of work).

41.2 All payments shall be made in Indian Rupees.

42. Security Deposit/ Retention Money

42.1 The Employer shall retain security deposit of 5% (Five percent) of the amount from each payment due to the Contractor until Completion of the whole of the Works.

42.2 The security deposit/retention money and the performance security will be released to the Contractor when the Defects Liability Period is successfully over, and the Engineer has certified that the Defects, if any, notified by the Engineer to the Contractor before the end of this period have been corrected.

42.3 If the Contractor so desires, then the Security Deposit/ retention money can be released on submission of unconditional Bank Guarantee at the following two stages:-

- a) At a point after the progress of work in financial term (gross value of work done) has reached 50% of the contract amount
- b) After the retention money has been deducted to the full value (5% of the contract amount).\

43. Liquidated Damages

43.1 The Contractor shall pay liquidated damages to the Employer at the rate or part there of stated in the Contract Data for each day that the Completion Date is later than the Intended Completion Date. The total amount of liquidated damages shall not exceed the amount defined in the Contract Data. The Employer may deduct liquidated damages from payments due to the Contractor. Payment of liquidated damages shall not affect the Contractor's other liabilities.

Both the parties expressly agree that the liquidated damages payable by the Contractor are mutually agreed genuine pre-estimated loss and without any proof of actual damages likely to be suffered and incurred by the Employer and the Employer is entitled to receive the same and are not by way of penalty.

43.2 If the Intended Completion Date is extended after liquidated damages have been paid, the Engineer shall correct any overpayment of liquidated damages by the Contractor by adjusting in the next payment certificate. The contractor shall not be paid interest on the over payment of liquidated damages.

44. Advance Payment

44.1 The Employer will make an interest bearing advance payment to the Contractor against provision by the Contractor of an Unconditional Bank Guarantee in a form and by a bank acceptable to the Employer in amounts equal to the advance payment up to 10% of Contract Price. The guarantee shall remain effective until the advance payment has been repaid, but the amount of the guarantee shall be progressively reduced by the amounts repaid by the Contractor. The Contractor shall take the above advance before 2nd running bill and if the contractor delays seeking the advance, the same is not payable.

44.2 The Contractor is to use the advance payment only to pay for Equipment, plant and Mobilization expenses required specifically for execution of the Works. The Contractor shall demonstrate that the advance payment has been used in this way by supplying copies of invoices or other documents to the Engineer.

44.3 The advance payment shall be repaid with interest @ SBI PLR applicable on the date of release of mobilisation advance, by deducting from payments otherwise due to the Contractor. The mobilisation advance will be recovered from third running bill upto 8th running bill in six equal installments and the interest will be recovered from 9th bill. In any case, the mobilisation advance with interest must be recovered within ten months from the date of agreement. No account shall be taken of the advance payment or its repayment in assessing valuations of work done, Variations, Compensation Events, or Liquidated Damages.

45. Performance Security

45.1 Subject to further condition in Contract Data, the Performance Security equal to **three percent of** the Contract Price shall be provided to the Employer no later than the date specified in the Letter of Acceptance and shall be issued in the form given in the Contract Data and by a prescribed bank. The Performance Security shall be valid until a date 60 days after the expiry of Defects Liability Period. The validity shall account for additional 3 months' time to account for BG verification, signing of contract and start date

46. Cost of Repairs

46.1 Loss or damage to the Works or Materials to be incorporated in the Works between the Start Date and the end of the Defects Liability Period shall be remedied/ rectified by the Contractor at his cost if the loss

or damage arises from the Contractor's acts or omissions.

E. FINISHING THE CONTRACT

47. Completion

47.1 The Contractor shall request the Engineer to issue a certificate of Completion of the Works, and the Engineer will do so upon deciding that the Works are completed.

48. Taking Over

48.1 The Employer shall take over the Site and the Works within seven days of the Engineer's issuing a certificate of Completion.

49. Final Account

50. The Contractor shall supply to the Engineer with a detailed account of the total amount that the Contractor considers payable under the Contract before the end of the Defects Liability Period. The Engineer shall issue a Defects Liability Certificate and certify any final payment that is due to the Contractor within 28 days of receiving the Contractor's account if it is correct and complete. If it is not, the Engineer shall issue within 28 days a schedule that states the scope of the corrections or additions that are necessary. If the Final Account is still unsatisfactory after it has been resubmitted, the Engineer shall decide on the amount payable to the Contractor and issue a payment certificate within 28 days of receiving the Contractor's revised account. Operation and Maintenance Manual

50.1 If "as built" Drawings and/ or operation and maintenance manuals are required relating to construction work carried out, the Contractor shall supply them within 28 days from the date of issue of certificate of completion.

50.2 If the Contractor does not supply the Drawings and/ or manuals by the stipulated date or they do not receive the Engineer approval, the Engineer shall withhold the amount equal to Rs.5 lakh from payments due to the Contractor.

51. Termination

51.1 The Employer or the Contractor may terminate the Contract if the other party causes a fundamental breach of the Contract.

51.2 Fundamental breaches of Contract include, but shall not be limited to, the following:

- A) Fundamental Breaches by the Contractor
- a) the Contractor stops work or grossly neglects Routine Maintenance Works and Services for 28 days when no stoppage of work is shown on the current programme and the stoppage has not been authorized by the Engineer;
 - b) the Contractor is declared as bankrupt or goes into liquidation other than for approved reconstruction or amalgamation;
 - c) the Engineer/ Employer gives Notice that failure to correct a particular Defect is a fundamental breach of Contract and the Contractor fails to remedy the defect and correct it within the period of time determined by the Engineer;
 - d) the Contractor does not maintain a Security Deposit as per clause;

- e) the Contractor has delayed the completion of Works by the number of days for which the maximum amount of liquidated damages can be paid, as defined in **Clause43**;
- f) the aggregate liability of the Contractor to the Employer, exceeds the total amount specified in the Contract Data, provided that this limitation shall not apply to the cost of repairing or replacing defective works and equipment;
- g) the Contractor fails to provide insurance cover as required under **Clause13**;
- h) if the Contractor, in the judgement of the Employer, has engaged in the corrupt or fraudulent practices as defined in **Clause 34** of the Instructions to Bidders in competing for or in executing the Contract;
- i) if the Contractor fails to set up a field laboratory with the prescribed equipment, within the period specified in the Contract Data;
- j) if the Contractor does not deploy any of the personnel stated in Contract Data within 45days of issue of notice to proceed;
- k) The Contractor violates the provisions of Child Labour (Prohibition & Regulation) Act, 1986;
- l) Any other fundamental breaches as specified in the contract data.

51.3 Without prejudice to any other right or remedies which the Employer may have under this contract upon occurrence of a Contractor's fundamental breach of contract, the Employer shall be entitled to terminate this contract by issuing a Termination Notice to the Contract or provided that before issuing the Termination Notice, the Employer shall by a Notice inform the Contractor of its intention to issue such Termination Notice and grant 15 days to the Contract or to make are presentation and may after the expiry of such15days, whether or not it is in receipt of such representation issue the Termination Notice.

51.4 Notwithstanding the above, the Employer may terminate the Contract for convenience.

51.5 If the Contract is terminated, the Contractor shall stop work immediately, make the Site safe and secure, and leave the Site as soon as reasonably possible.

52. Payment upon Termination

52.1 If the Contract is terminated because of a fundamental breach of Contract by the Contractor, the Engineer shall issue a certificate for the value of work done and Materials ordered less advance payments received up to the date of issue of the certificate and less the percentage to apply to the value of the work not completed, as indicated in the Contract Data. If the total amount due to the Employer exceeds any payment due to the Contractor, the difference shall be a debt payable to the Employer and Employer may recover the same from Performance Bank Guarantee.

52.2 If the Contract is terminated at the Employer's convenience, the Engineer shall issue a certificate for the value of work done, and a pre-determined amount specified in the contract data to cover the reasonable cost of removal of Equipment and repatriation of the Contractor's personnel employed solely on the Works, and the Contractor's costs of protecting and securing the Works and less advance payments received up to the date of the certificate, less other recoveries due in terms of the Contract, and less taxes due to be deducted at source as per applicable law.

53. Property

53.1 All Materials on Site, Plant, Equipment, Temporary Works and Works shall be deemed to be the property of the Employer for use for completing balance work if the Contract is terminated because of the Contractor's default.

54. Release from Performance

54.1 If the Contract is frustrated by the outbreak of war or by any other event entirely outside the control of the Employer or the Contractor, the Engineer shall certify that the Contract has been frustrated. The Contractor shall make the Site safe and stop work as quickly as possible after receiving this certificate and shall be paid for all work carried out before receiving it and for any work carried out afterwards to which a commitment was made.

F. OTHER CONDITIONS OF CONTRACT

55. Labour

55.1 The Contractor shall, unless otherwise provided in the Contract, make his own arrangements for the engagement of all staff and labour, local or other, and for their payment, housing, feeding and transport; and for compliance of various labour laws/ regulations.

55.2 The Contractor shall, if required by the Engineer, deliver to the Engineer a return in detail, in such form and at such intervals as the Engineer may prescribe, showing the staff and the numbers of the several classes of labour from time to time employed by the Contractor on Site and such other information as the Engineer may require.

55.3 The Contractor's personnel including equipment operators shall be appropriately qualified, skilled and experienced in their respective trades or occupations. The Engineer may require the Contractor to remove or cause to be removed any person employed on the site or the works, including the Contractor's representative, if applicable, who

- a) Persists in any misconduct or lack of care;
- b) Carries out duties incompetently or negligently;
- c) Falls to conform with any provision of the contract;
- d) Persists in any conduct which is prejudicial to safety, health or protection of the environment.

If appropriate, the contractor shall then appoint or cause to be appointed a suitable replacement person

56. Compliance with Labour Regulations

56.1 During continuance of the Contract, the Contractor and his sub-Contractors shall abide at all times by all existing labour enactments and rules made there under, regulations, notifications and bye laws of the State or Central Government or local authority and any other labour law (including rules), regulations, byelaws that may be passed or notification that may be issued under any labour law in future either by the State or the Central Government or the local authority. (Salient features of some of the major labour laws that are applicable to construction industry are given in Addendum to General Conditions of Contract.) The Contractor shall keep the Employer indemnified in case any action is taken against the Employer by the competent authority on account of contravention of any of the provisions of any Act or rules made there under, regulations or notifications including amendments. If the Employer is caused to pay or reimburse, such amounts as may be necessary to cause or observe, or for non-observance of the provisions stipulated in the notifications/ bye laws/ Acts/ Rules/ regulations including amendments, if any, on the part of the Contractor, the Employer shall have the right to deduct any money due to the Contractor including his amount of performance security. The Employer shall also have right to recover from the Contractor any sum required or estimated to be required for making good the loss or damage suffered by the Employer.

In no case shall the employees of the Contractor and the Sub-Contractor be treated as the employees of the Employer at any point of time.

57. Drawing and Photographs of the Works

57.1 The Contractor shall do photography/video photography of the site firstly before the start of work, secondly mid-way in the execution of different stages of work and lastly after the completion of each item of work. No separate payment will be made to the contractor for this.

57.2 The Contractor shall not disclose details of Drawings furnished to him and works on which he is engaged without the prior approval of the Engineer in writing. No photograph of the works or any part thereof or plant employed thereon, except those permitted under **Clause 57.1**, shall be taken or permitted by the Contractor or to be taken by any of his employees or any employees of his sub-Contractors without the prior approval of the Engineer in writing. No photographs/ video photography shall be published or otherwise circulated without the approval of the Engineer in writing.

58. The Apprentices Act, 1961

58.1 The Contractor shall duly comply with the provisions of the Apprentices Act, 1961 (Ill of 1961), the rules made there under and the orders that may be issued from time to time under the said Act and the said Rules and on his failure or neglect to do so, he shall be subject to all liabilities and penalties provided by the said Act and said Rules.

CONTRACT DATA

Items marked "N/A" do not apply in this Contract.1.1

- | | | |
|-----|--|--------------------------------|
| 1. | The Employers is
National Highways and Infrastructure Development Corporation Ltd.
3rd Floor, PTI Building,
Name of authorized Representative
Executive Director (Projects)
Email Id: ronhidcljammu@gmail.com
National Highways& Infrastructure Development Corporation Ltd.
Regional Office, Jammu | [C1.1.of ITB] |
| 2. | Engineer:
Designation: GM(P), PMU Doda, NHIDCL
Address: PMU Doda Chenab view guest house
Near IOCL petrol pump Doda. | [C1.1.of GCC] |
| 3. | The Intended Completion Date for the whole of the Works is [09 months
from Start Date] | [Cl. 1.1, 17 & 26
of GCC] |
| 4. | The location of site is given in the Bid
notice [Sr no 1 of NIT] | [Sr. No.1 of NIT] |
| 5. | The Start Date shall be within 15 days for the date of issue of the Notice
to proceed with the work. | [C1.1.of GCC] |
| 6. | (a)The name and identification number of the Contract is _ Restoration
 & Repair of Batote Khellani road (existing NH-244) by way of
 Laying of Bituminous Macadam & Bituminous Concrete,
 Breast/wall, Pucca & Kachha Drain, Culverts, Road Marking &
 Road Transverse Strips, Delineators, Flickering Cat eyes etc., from
 Km. 0.000 to km 45.000 on Batote-Khellani stretch of existing NH-244 in
 the UT of Jammu & Kashmir." | [C1.1.1of ITB] |
| 7. | (a) The law which applies to the Contract is the law of Union of India.
(b)The language of the Contract documents is English | [Cl.3.1ofGCC]
[Cl.3.1ofGCC] |
| 8. | The limit of subcontracting is NIL of initial contract price | [Cl.7.1ofGCC] |
| 9. | Schedule of other Contractor- NIL | [Cl.8.1ofGCC] |
| 10. | Technical Personnel are as given in the ITB | [Cl.9.1of GCC] |

SL. No.	Personnel	Qualification	Particular Experience (minimum requirement)	No. of Persons
1	Project Manager	B.E (Civil) or equivalent + 10 Years Exp.	5 years on slope protection work in hilly terrain incl highway constructions / maintenance work.	1

2	Site Engineer cum Quantity Surveyor	B.E (Civil) + 3Years Exp. Or Diploma + 5 Years Exp.	2 years on highway constructions / maintenance work.	1
3	Geotechnical expert (Part time)	B.E. Civil+ 7 Years Exp. Or Diploma Civil.+ 7 Years Exp.	2 years on slope protection work in hilly terrain incl highway constructions / maintenance work.	1
4	Material Engineer	B.E. Civil+ 7 Year Exp. Or Dip. Civil+ 7-year Exp.	2 years on highway constructions / maintenance work	1
			Total	4

11. Amount for insurance are: **[Cl.13.1 of GCC]**

- a) Rupees equivalent to Contract Price.
- b) Rupees equivalent to 5% of Contract Price.
- c) Rupees equivalent to 5% of Contract Price.
- d) Rupees 20 lakhs for multiple incidents.

The said insurance shall include all liabilities as per **Clause13.1** and shall be deductible as per premium rate.

12. Site Investigation Report-NIL **[Cl14.1 of GCC]**

13. The period for submission of the programme for approval of Engineer shall be 30days from the issue of Letter of Commencement. **[Cl.25.1 of GCC]**

14. Amount to be withheld for delays in submission of updated programme: 1% of value of work corresponding to the updated programme. **[Cl. 25.4 of GCC].**

15. The period for setting up a field laboratory with the prescribed equipment Relevant to items of work in BOQ is 30 days from the date of notice to start work **[Cl.30.1ofGCC]**

16. The Defect Liability Period will be as per Cl. 31.4 of Section-5 of GCC.**[Cl.31of GCC]**

17.

a. Amount of liquidated damages for delay incompletion of works	0.1 percent of the remaining value of contract to be executed, rounded off to the nearest thousand, per day with the minimum of Rs.10,000/-per day
b. Maximum limit of liquidated damages for delay incompletion of work.	10 percent of the Initial Contract Price rounded off to the nearest thousand [Clause.43 of GCC]

18. The standard form of Performance Security acceptable to the Employer shall be an Unconditional Bank Guarantee of the type as specified in the Bidding Documents.

[Cl.45.1 of GCC]

19. The percentage to apply to the value of work not completed representing the Employer's additional cost for completing the work shall be 20percent. The Performance Security shall also be forfeited if the Contract is terminated because of a fundamental breach of Contract by the Contractor. **[Cl.52.1 of GCC]**
20. The reasonable cost of removal of equipment and repatriation of the Contractor's personnel employed solely on the works in the event of termination of the contract at the Employer's convenience or because of a fundamental breach of contract by the Employer is to be treated as [-----] lac. **[Cl.52.2 of GCC]**

SECTION 6

ADDENDUM TO GENERAL CONDITIONS OF CONTRACT

SECTION 6

ADDENDUM TO GENERAL CONDITIONS OF CONTRACT

SALIENT FEATURES OF SOME MAJOR LABOUR LAWS APPLICABLE TO ESTABLISHMENTS ENGAGED IN BUILDING AND OTHER CONSTRUCTION WORKS.

- a) **Workmen Compensation Act, 1923:** The Act provides for compensation in case of injury by accident arising out of and during the course of employment.
- b) **Payment of Gratuity Act; 1972:** Gratuity is payable to an employee under the Act on satisfaction of certain conditions if an employee has completed the prescribed minimum years (five years) of service or more or on death the rate of prescribed minimum days' (15 days) wages for every completed year of service. The Act is applicable to all establishments employing the prescribed minimum number (10) or more employees.
- c) **Employee's P.F. and Miscellaneous Provision Act 1952:** The Act provides for monthly contributions by the Employer plus workers at the prescribed rate (10percent or 8.33percent). The benefits payable under the Act are:
 - i) Pension or family pension on retirement or death as the case may be.
 - ii) Deposit linked insurance on the death in harness of the worker.
 - iii) Payment of P.F. accumulation on retirement/ death etc.
- d) **Maternity Benefit Act, 1961:** The Act provides for leave and some other benefits to women employees in case of confinement or miscarriage etc.
- e) **Contract Labour (Regulation & Abolition) Act, 1970:** The Act provides for certain welfare measures to be provided by the Contractor to contract labour and in case the Contractor fails to provide, the same are required to be provided, by the Principal Employer by Law. The principal Employer is required to take Certificate of Registration and the Contractor is required to take license from the designated Officer. The Act is applicable to the establishments or Contractor of Principal Employer if they employ minimum prescribed (20 or more) numbers of contract labour.
- f) **Minimum Wages Act, 1948:** The Employer is to pay not less than the Minimum Wages fixed by appropriate Government as per provisions of the Act if the employment is a scheduled employment. Construction of buildings, roads, runways are scheduled employment.
- g) **Payment of Wages Act, 1936:** It lays down as to by what date the wages are to be paid, when it will be paid and what deductions can be made from the wages of workers.
- h) **Equal Remuneration Act, 1979:** The Act provides for payment of equal wages for work of equal nature to male and female workers and for not making discrimination against female employees in the matters of transfers, training and promotions etc.
- i) **Payment of Bonus Act, 1965:** The Act is applicable to all establishments employing minimum prescribed (say, 20 or more) number of workmen. The Act provides for payments of annual bonus within the prescribed range of percentage of wages to employees drawing up to the prescribed amount of wages, calculated in the

prescribed manner. The Act does not apply to certain establishments. The newly set-up establishments are exempted for five years in certain circumstances. States may have different number of employment size.

- j) **Industrial Disputes Act, 1947:** The Act lays down the machinery and procedure for resolution of industrial disputes, in what situations a strike or lock-out becomes illegal and what are the requirements for laying off or retrenching the employees or closing down the establishment.
- k) **Industrial Employment (Standing Orders) Act, 1946:** It is applicable to all establishments employing minimum prescribed number of persons (say, 100, or 50). The Act provides for laying down rules governing the conditions of employment by the Employer on matters provided in the Act and get these certified by the designated Authority.
- l) **Trade Unions Act, 1926:** The Act lays down the procedure for registration of trade unions of workmen and employees. The Trade Unions registered under the Act have been given certain immunities from civil and criminal liabilities.
- m) **Child Labour (Prohibition & Regulation) Act, 1986:** The Act prohibits employment of children below 14 years of age in certain occupations and processes and provides for regulations of employment of children in all other occupations and processes. Employment of child labour is prohibited in building and construction industry.
- n) **Inter-State Migrant Workmen's (Regulation of Employment & Conditions of Service) Act, 1979:** The Act is applicable to an establishment which employs minimum prescribed number of labour (say, five or more) inter-state migrant workmen through an intermediary (who has recruited workmen in one state for employment in an establishment situated in another state). The Inter-State migrant workmen, in an establishment to which this Act becomes applicable, are required to be provided certain facilities such as Housing, Medical-Aid, Travelling expenses from home upto the establishment and back etc.
- o) **The Building and Other Construction Workers (Regulation of Employment and Conditions of Service) Act, 1996 and the Cess Act of 1996:** All the establishments who carry on any building or other construction work and employ the minimum prescribed (say, 10 or more) number of workers are covered under this Act. All such establishments are required to pay cess at the rate not exceeding 2 percent of the cost of construction as may be notified by the Government. As per current notification, one percent of the cost of construction is payable by the Employer of the establishment. The Employer of the establishment is required to provide safety measures at the building or construction work and other welfare measures, such as canteens, first-aid facilities, ambulance, housing accommodations for workers near to the work place etc. The Employer to whom the Act applies has to obtain a registration certificate from the Registering Officer appointed by the Government.
- p) **Factories Act, 1948:** The Act lays down the procedure for approval of plans before setting up a factory, health and safety provisions, welfare provisions, working hours, annual earned leave and rendering information regarding accidents or dangerous occurrences to designated authorities. It is applicable to premises employing the minimum prescribed number of persons (say, 10 persons or more) with aid of power or another minimum prescribed number of persons (say, 20 or more persons) without the aid of power engaged in manufacturing process.

SECTION -7

**ROAD MAINTENANCE STANDARDS AND SPECIFICATIONS FOR ROAD
MAINTENANCE WORKS, PART-I AND PART-II**

SECTION-7

ROAD MAINTENANCE STANDARDS AND SPECIFICATIONS FOR ROAD MAINTENANCE WORKS, PART-I AND PART-II & SCOPE OF WORK

PREAMBLE:

The Technical Specifications contained herein shall be read in conjunction with the other Bidding Documents as specified.

GENERAL REQUIREMENTS

The Technical Specifications in accordance with which the entire work described hereinafter shall be executed and completed by the Contractor shall comprise of the following:

PART - I - GENERAL TECHNICAL SPECIFICATIONS

The General Technical Specifications shall be the "SPECIFICATIONS FOR ROAD AND BRIDGE WORKS" (FIFTH REVISION, April 2013) issued by the Ministry of Road Transport & Highways, Government of India and published by the Indian Roads Congress, hereinafter referred to as MORT&H Specifications and relevant applicable IRC Codes.

PART - II - SUPPLEMENTARY TECHNICAL SPECIFICATIONS

The Supplementary Technical Specifications shall comprise of various Amendments/ Modifications/ Additions to the 'SPECIFICATIONS FOR ROAD AND BRIDGE WORKS' referred to in PART-I above and Additional Specifications for particular item of works not already covered in Part-I.

A particular clause or a part there of in "SPECIFICATIONS FOR ROAD AND BRIDGE WORKS" (FIFTH REVISION, April 2013), referred in Part-I above, where Amended/ Modified/ Added upon and incorporated in Part-II, referred to above, the Amendment/ Modification/ Addition supersedes the relevant clause or part of the clause.

When an Amended/ Modified/ Added Clause supersedes a Clause or part thereof in the said Specifications, then any reference to the superseded clause shall be deemed to refer to the Amended/ Modified/ Added Clause or part thereof.

In so far Amended/ Modified/ Added Clause may come in conflict or be inconsistent with any of the provisions of the MORTH Specifications under reference, the Amended/ Modified/ Added clause and the additional specifications shall always prevail.

In the absence of any definite provisions on any particular issue in the aforesaid Specifications, reference may be made to the latest codes and specifications of IRC and BIS in that order, Where even these are silent, the construction and completion of the works shall conform to sound engineering practice as approved by the Engineer and, in case of any dispute arising out of the interpretation of the above, the decision of the Engineer shall be final and binding on the Contractor.

The Authority/Client shall get the 3rdparty quality audit of bituminous work.

Scope of Work:

- **Road maintenance**- As per Scope of work.

Inspection

Full and complete inspection of the highway section shall be undertaken at appropriate intervals as mentioned in this section. The Contractor shall provide appropriate testing equipment for qualitative inspections, such as reflectivity meters, straight edges and the like.

Daily followed by weekly and monthly Inspections

Items to be inspected daily on regular basis followed by weekly and monthly inspections shall include:

- Potholes
- Cleaning of carriageway/ shoulder/ drain
- Other maintenance activities

Repairs

Repairs arising out of the inspections shall be carried out by the Contractor after a joint assessment with the Engineer and approval of NHIDCL.

Note- Other maintenance requirement will be applicable as per IRC SP124-2019, Section-07, Part-1, Para-2.

PERFORMANCE STANDARDS

PERFORMANCE STANDARDS FOR MAINTENANCE:

The performance standards define the level at which the proposed facility is to be maintained and operated.

Road Maintenance: (As per MORT&H Specifications)

SN	Serviceability Indicator	Permissible time limit for defect rectification	Frequency of Inspections by the contractor to ensure required level of service
1.	Potholes	24 Hrs	Daily on regular basis followed by weekly & monthly inspections
2.	Cracking & patch (max. Permissible)	Seven days	-do -
3.	Cleaning of drain & culverts	24hrs	-do -
4.	Repair of Road safety items like Crush Barrier, signages, Road marking, Delineator, Studs, Hazards markers etc within the scope	Seven days	-do-

• Maintenance Standards for BOQ Items

i) Maintenance standards for repairing roadside open drains and cross drainage works

- i) The work shall consist of cleaning, clearing, deepening and reshaping of roadside drains and making shallow lateral drains on shoulders to drain out the rain water/ surface water effectively from bituminous surface as well as from roadside berms.
- ii) Disposal of sediments, extraneous debris or vegetation growth, blocking flow.
- iii) Safety devices and signs shall be placed as per MoRTH Specifications for Road and Bridge Works (5th Revision) Clause No. 112.
- iv) The excavated material shall be disposed off as directed by Engineer-in-charge with all leads

and lifts.

- v) The drain slopes and sides shall be dressed up to original flow line and cross section.

ii) Maintenance standards for “carrying out cleaning, removing of Landslide / Debris from carriageway.

- i) However, width of carriageway to be kept clean as per BOQ provision is up to ROW, it includes;
 - a) Total width of carriageway (LHS + RHS) including median width.
 - b) Width of service roads (LHS + RHS) wherever service roads are in existence.
 - c) Width of all structures such as flyovers, major bridges, minor bridges, culverts, subways, etc.
- ii) For cleaning of carriageway, the Contractor shall deploy Hydraulic dozer & excavator with dumper. Contractor shall maintain log book of this Hydraulic dozer & excavator with dumper and submit the Xerox of this along with statement of work done.

iii) Maintenance standards for “Removal of rank vegetation/weeds from shoulders

- i. The contractor shall keep the shoulders upto Right of Way (RoW) on both sides complete in all respects.
- ii. The work shall include breaking of clods, rough dressing and disposal of waste and vegetation outside RoW as per directions of the Engineer.
- iii. The contractor shall maintain separate signed muster rolls of deployed labours & supervisors and log books of tractors. The muster rolls and log books shall be made available for inspection. Xerox copy of log books and muster rolls shall be submitted along with statement of work done by the contractor.
- iv. If a contractor fails to keep the specified area without weeds, unwanted vegetation, debris (as per provision of BOQ), a penalty of Rs. 500/km/incidence shall be imposed. The Engineer’s decision in this context is binding on the Contractor.

iv) Maintenance standards for routine maintenance of road signs and delineators

- i) The work shall consist of washing of signs, delineators, removal of posters etc. and repair to supporting structures with repainting.
- ii) The road signs and delineators should be thoroughly washed using a detergent solution followed by a lean rinse and whole face of the sign shall be dried.
- iii) Defects in supporting structures like bullet holes, surface marks or bent posts shall be repaired with appropriate tools.
- iv) Damaged area shall be cleaned and loose/flaking paint shall be removed. Bullet holes shall be filled with filler and supporting structures shall be painted with first quality enamel paint in two or more coats.

PART-II

SPECIFICATIONS FOR ROAD MAINTENANCE WORKS

1. General

- 1.1** All materials, works and construction operations shall conform to the requirements laid down in the "Specifications for Road and Bridge Works" (5th Revision), Ministry of Road Transport and Highways, Published by Indian Roads Congress (IRC), New Delhi; IRC:82 "Code of Practice for Maintenance of Bituminous Surfaces on Highways" and IRC:SP:83 Guidelines for Maintenance, Repairs and Rehabilitation of Cement Concrete Pavements" wherever applicable. Where the Specification for a work is not given, sound engineering practice shall be adopted to the satisfaction of the Engineer. "Specifications for Road and Bridge Works, Ministry of Road Transport and Highways" (5th Revision) is hereinafter referred to as MoRTH Specifications.

2 Arrangement for Traffic during Construction

- 2.1** The Contractor shall take all necessary measures and make arrangements for the safety during construction in accordance with the requirements of Clause 112 of MoRTH Specifications. He shall provide, erect and maintain all such barricades, signs, markings, flags, lights as required or directed by the Engineer for safety of traffic passing through the section under repairs/improvement.
- 2.2** All maintenance works on the road shall be carried out in a manner which would cause least interference to the traffic. In stretches where resurfacing or riding quality improvement works are to be taken up, the Contractor during execution of work shall provide and maintain proper passage for traffic. Where it is not possible or safe to allow traffic on part width of the carriageway, a temporary diversion of proper Specifications shall be constructed by the Contractor at his cost. The Contractor shall take prior approval of the Engineer regarding traffic arrangements during construction.
- 2.3** All arrangements for traffic during construction shall be considered as incidental to the work and shall be Contractor's responsibility. The Engineer shall determine the penalty to be imposed on the Contractor for deficiency in compliance to the requirement.

3 Quality Control

- 3.1** Quality control on materials and workmanship is the primary responsibility of the Contractor. Quality control shall be exercised in accordance with the Quality Plan approved by the Engineer. The Engineer may, during and after construction test the quality of materials and work in order to verify conformance with the prescribed Specifications.
- 3.2** An attempt shall be made to attend to defects like potholes, undulations, rutting, bleeding, linear and alligator cracks and eroded edges etc. at an initial stage itself. Thermal bonded patches of regular rectangular shapes without bump or sump shall preferably be adopted.
- 3.3** In order to avoid the sudden jerk at the end of overlaying, smooth transition shall be ensured by the Contractor.

4 Specifications for Routine Maintenance

Before any work is started, signs, barriers, etc. shall be placed and necessary arrangements made for

ensuring safety of traffic and workers in the work zone, as described in Clause 2 of this Section Preparation of the surface prior to application of any treatment, shall be carried out in accordance with the relevant Clauses of MoRTH Specifications. After completion of the work, the site shall be left cleaned and tidy. No stockpiles of material shall be left on the road.

SECTION - 8

DESIGN AND SCHEDULE OF DRAWINGS

As per Annexure-

SECTION-9

FINANCIAL BID FORM AND BILL OF QUANTITIES

FINANCIAL BID FORM

To

(Authorized Representative of Employer)

DESCRIPTION OF WORKS: BID FOR (Name of work)

Reference letter No.....

Dear Sir,

Having examined the site of works and Bid Documents, comprising Instructions to Bidders, Scope of Works, Conditions of Contract, Technical Specifications, Bill of Quantities and schedules for the execution of the above named works, we, the undersigned offer to execute and complete such works and remedy any defects therein in conformity with the said bid documents at tender premium as quoted in the Financial Bid.

- 1. We undertake, four Bid is accepted, to commence the work within fifteen (15) days of receipt of the order to commence, and to complete and deliver the sections and whole of the works comprised in the contract within the period stated in the bid here to.
- 2. If our Bid is accepted, we will furnish Performance Security (ies) in the form of a Bank Guarantee to be jointly and severally bound on us, in accordance with the Conditions of Contract.
- 3. We agree to abide by this Bid for a period of One Hundred twenty (120) days from the last date fixed for Bid Submission and it shall remain binding upon us and may be accepted at any time before the expiry of that period.
- 4. We confirm our agreeme0nt to treat the Bid document and other records connected with the works as secret and confidential documents and shall not communicate information contained there into any person other than the person authorized by the Employer or use such information in any manner prejudicial to the safety and integrity of the works.
- 5. Unless and until an agreement is prepared and executed, this Bid, together with your written acceptance thereof, shall constitute a binding contract between us, but without prejudice to your right to withdraw such acceptance without assigning any reasons thereof.
- 6. We understand that you are not bound to accept the lowest or any bid you may receive.

Dated this _____ day of _____ 20-----

Signature _____ in the capacity of _____ duly authorized**

To Sign Bid for and on behalf of

(in block capital letters)

Address: _____ Signature of Witness _____ Name of witness _____ Address of witness _____

DESCRIPTION OF WORKS: FINANCIAL BID

S.No.	Description	Amount
1	Grand Total of BOQ	Rs.....(Excl 18 % GST) (Rupees..... only)

I/ We here by agree to execute the above work on the tender

- (i) At par of the Grand of the Project Cost as given above
- (ii) At Premium
[Figures/words] _____ % above on the Grand of the Project
Cost as given above.
- (iii) At discount
[Figures/words] _____ % below on the Grand of the Project
Cost as given above

***IF FILLED IN TECHNICAL BID, BIDDER SHALL BE DISQUALIFIED**

BILL OF QUANTITIES

1. Preamble

- i) The Bill of Quantities (BOQ) shall be read in conjunction with the Instructions to Bidders, Conditions of Contract, Road Maintenance Standards and Specifications for Road Maintenance Works.
- ii) The quantities given in the Bill of Quantities are estimated quantities. The basis of payment will be actual quantities of items of work carried out and valued at the rates tendered in the BOQ along with accepted/awarded tender premium. The accepted/ awarded tender premium above/below the grand total of the project cost shall be applicable for individual items of work to determine payable amount to Contractor for work done subject to other contractual provisions. Any variation shall be dealt with as per contract provisions.
- iii) The rates and prices tendered in the BOQ shall include all equipment, tools, spares, labour, supervision, overheads, consumables, materials, erection, maintenance, testing of input material delivered, profit, taxes and duties together with general risks, liabilities and obligations set out and implied in the contract and other incidentals to comply with the requirements of Standards and Specifications.
- iv) The rates and prices shall be quoted entirely in Indian Currency.
- v) Deleted
- vi) The whole cost of complying with the provisions of the contract shall be included in the items provided in the priced Bill of Quantities and where no rates are provided the cost shall be deemed to be distributed among the rates and prices entered for the related items of work.
- vii) The contractor shall keep the entire carriageway neat and clean throughout the contract period. The contractor shall maintain guard rails, railings, crash barriers, road furniture etc. in good condition by cleaning them frequently as advised / required by using suitable detergents/chemicals.
 - The staff of the contractor shall wear safety jackets, shoes, helmets etc. while on duty and any violation will attract a fine of Rs. 5,000/- for each incident.
 - Failure to erect safety signage or trying to carry out the works without proper precautions/safety measures as required will attract a fine of Rs.5,000/- for each incident.
- viii) General directions and descriptions of work and materials are not necessarily repeated or summarized in the Bill of Quantities. Reference to the relevant sections of the bidding document shall be made before entering rates or prices against each item in the Bill of Quantities.
- ix) The Contractor shall submit at least once in two months video recording of condition of the Project Highway with special emphasis on performance based items.

Name of Work: - Restoration & Repair of Batote Khellani road (existing NH-244) by way of Laying of Bituminous Macadam & Bituminous Concrete, Breast/wall, Pucca & Kachha Drain, Culverts, Road Marking & Road Transverse Strips, Delineators, Flickering Cat eyes etc., from Km 0.000 to Km 45.000 on Batote-Khellani stretch of existing NH-244 in the UT of Jammu & Kashmir for FY 2025-26.

SUMMARY

S.NO.	DESCRIPTION	AMOUNT (Rs.) Excl GST
1.	Restoration & Repair of Batote Khellani road (existing NH-244) by way of Laying of Bituminous Macadam & Bituminous Concrete, Breast/wall, Pucca & Kachha Drain, Culverts, Road Marking & Road Transverse Strips, Delineators, Flickering Cat eyes etc., from Km 0.000 to km 45.00 on Batote-Khellani stretch of existing NH-244 in the UT of Jammu & Kashmir for FY 2025-26.	₹ 6,34,54,713.00
	TOTAL (Rs.)	₹ 6,34,54,713

Item No	Item of Work	Qty.	Unit
1	Laying of BM & BC		
1.1	Laying of WBM - Laying, spreading and compacting stone aggregate of specified sizes to WBM specifications (75 mm thick) in uniform thickness, hand picking, rolling with 3 wheeled road / vibratory roller 8-10 tonne capacity in stages to proper grade and camber, applying and brooming requisite type of screening /binding material to fill up interstices of coarse aggregate, watering and compacting to the required density.	473.00	Cum
1.2	Laying of Prime Coat - Providing and applying prime coat using bitumen emulsion conforming to IS: 8887, using emulsion pressure distributor including preparing the surface and cleaning with mechanical broom. 16.39.2.1 With medium setting bitumen emulsion On W.B.M. @ 0.4 Kg/sqm.	6300.00	Sqm
1.3	Laying of BM -Providing and laying bituminous macadam 50 mm thick using crushed stone aggregates of specified grading premixed with bituminous binder, transported to site by tippers, laid over a previously prepared surface with paver finisher equipped with electronic sensor to the required grade, level and alignment and rolling with smooth wheeled, vibratory and tandem rollers as per specifications to achieve the desired compaction and density, complete as per specifications and directions of Engineer-in-Charge. 16.63.1 50 mm average compacted thickness with bitumen of grade VG-30 @ 3.5% (percentage by weight of total mix) prepared in Batch Type Hot Mix Plant of 100-120 TPH capacity.	1017.00	Cum
1.4	Laying of Tack Coat - Providing and applying tack coat using bitumen emulsion conforming to IS: 8887, using emulsion pressure distributor including preparing the surface and cleaning with mechanical broom. 16.39.1 With rapid setting bitumen emulsion on bituminous surface @ 0.25 Kg/sqm.	78890.00	Sqm
1.5	Scarifying the existing road bituminous surface including disposal	58541.00	Sqm
1.6	Providing and laying bituminous concrete with 100-120 TPH batch type hot mix plant producing an average output of 75 tonnes per hour using crushed aggregates of specified grading, premixed with bituminous binder @ 5.4 to 5.6 per cent of mix and filler, transporting the hot mix to work site, laying with a hydrostatic paver finisher with sensor control to the required grade, level and alignment, rolling with smooth wheeled, vibratory and tandem rollers to achieve the desired compaction as per MORTH specification clause No. 509 complete in all respects	2367.00	Cum
2	Construction of B/Wall		
2.1	Earth work in bulk excavation by mechanical means (hydraulic excavator) over areas (exceeding 30 cm in depth, 1.5 m in width as well as 10 m ² on plan) including disposal of excavated earth with all leads & lifts, as directed by Engineer-in-Charge. Soil = 70% OR =30%	600.00	Cum
2.2	P/L in position cement concrete of specified grade 1:3:6 in foundation including cost of formwork	162.00	Cum
2.3	P/L in position cement concrete of specified grade 1:2:4 using 20mm nominal size crushed including cost of formwork	24.00	Cum
2.4	Random Rubble stone masonry with hard nallah stone in foundations upto plinth with 1:6 cement mortar including weep holes complete in all respects	913.00	Cum
2.5	Back filling behind R/Walls, wing walls, Return wall etc.	96.00	Cum
Construction of Pucca Drain			
3			
3.1	Plain cement concrete of M20 Grade in structure complete as per drawing and technical specifications including cost of formwork.	272.00	Cum
4	Hill Side Drain Clearance/Kachha Drain		
4.1	Removal of Earth from the choked Hill Side Drain/ Construction of Kachha Drain and disposing it on valley side manually.	15000.00	Rmt

5	Construction of RCC Box Culvert at Km 11.700 (1X6X6), Km 33.300 (1X6X6) & Km 31.300 (1X2X2), from Km 0.000 (Batote) to Km 45.000 (Khellani) On NH-244	Total Quantity	Unit
5.1	Earth work in bulk excavation by mechanical means (hydraulic excavator) over areas (exceeding 30 cm in depth, 1.5 m in width as well as 10 m ² on plan) including disposal of excavated earth with all leads & lifts, as directed by Engineer-in-Charge. Soil = 70% OR =30%	1479.000	Cum
5.2	Providing and laying of PCC M15 levelling course below Culvert, Catch Pit etc.	27.000	Cum
5.3	Providing and laying in position machine batched and machine mixed design mix M-30 grade cement concrete for reinforced cement concrete work, using cement content as per approved design mix, including pumping of concrete to site of laying, the cost of centering, shuttering, finishing and reinforcement All works upto plinth level (Foundation +Substructure + Superstructure)	396.000	Cum
5.4	Providing weepholes in brick masonry/stone masonry, plain/reinforced concrete abutment, wing wall, return wall with 100 mm dia uPVC pipe extending through the full width of the structures with slope of 1(V):20(H) towards drawing face complete as per drawing and technical specification.	480.000	NOS/Rmt
5.5	Backfilling of Sandy Material behind abutment, wing wall and retaining wall complete as per drawings & technical specification	229.000	Cum
5.6	Supplying, fitting and placing HYSD bar reinforcement (Fe 550 D) in Foundation, Substructure, superstructure, Catch Pit, Parapet Wall complete as per drawings and technical specification.	38.000	MT
5.7	Providing and laying reinforced cement concrete M40 in Crash Barrier complete as per drawing and technical specifications.	9.000	Cum
5.8	Painting of Crash Barrier	22.000	Sqm
5.9	Random Rubble Stone Masonry for Flexible Apron/ Guide Walls	98.000	Cum
5.10	Coping 1:2:4 over guide Flexible Apron/ Guide Walls	5.000	Cum
6	Road Marking & Transverse Strips		
6.1	Providing and applying 2.5mm thick road marking strips (retro-reflective) of specified shade/colour using hot thermoplastic material by fully/semiautomatic thermoplastic paint applicator machine fitted with profile shoe, glass beads dispenser, propane tank heater and profile shoe heater, driven by experienced operator on road surface including cost of material, labour, T&P, cleaning the road surface of all dirt, seals, oil, grease and foreign material etc. complete as per direction of Engineer-in-charge and accordance with applicable specifications. Road Marking	4226	sqm
6.2	Providing and applying 2.5mm thick road marking strips (retro-reflective) of specified shade/colour using hot thermoplastic material by fully/semiautomatic thermoplastic paint applicator machine fitted with profile shoe, glass beads dispenser, propane tank heater and profile shoe heater, driven by experienced operator on road surface including cost of material, labour, T&P, cleaning the road surface of all dirt, seals, oil, grease and foreign material etc. complete as per direction of Engineer-in-charge and accordance with applicable specifications.(Transverse Strips)	1890	sqm
7	Installation of Delineators/Flickering solar studs		
7.1	Providing and fixing post delineators made of ABS round body fitted with 3 nos. 100mm dia high reflective and reflectors and mounted on M.S. pipe of 65mm dia duly powder coated with anti-rust and anti-theft steel to be installed as per direction of Engineer-in-charge.	770	Nos.
7.2	Supplying of Solar Raised Pavement Markers made of polycarbonate molded body with circular shape, solar powered, LED self-illumination in active mode, 360-degree illumination and reflective panels with micro prismatic lens capable of providing total internal reflection of the light entering the lens face in passive mode. The marker shall support a load of 20000 kg tested in accordance to ASTM D 4280. The marker should be resistant to dust and water ingress according to IP 65 standards and should withstand temperatures in the range of 0 C to 70 C. Color of lighting could be provided in red or yellow (amber) as per requirement and typical frequency of blinking is 1 Hz. There should	2590	Nos.

<p>be current losses of less than 20 microamperes at 2.4 V in sleep charging mode to enhance the life of the marker and a full charge should provide for a minimum autonomy of 50 hours. The height, width and length of the marker shall not be less than 10 mm x 100 mm x 100 mm. Also, the surface diameter of the marker shall not be less than 100 mm respectively. The weight of the marker shall not exceed 0.5 Kilograms. Fixing will be by drilling holes on the road for the shanks to go inside, without nails and using epoxy resin based adhesive and complete as directed by the engineer.</p>		
--	--	--

Note: In case of any error of Clause of MoRTH Specifications, the appropriate correct clause of the MoRTH Specifications shall prevail, as per the decision of Engineer-in-Charge/Employer.

Proposed Location of WBM, BM, BC on Batote Khellani Road

S.No	Km	RD	Proposed Length WBM	Proposed Length BM	Scarifying	Proposed Length BC	Remarks
1	1	0-1000	0	0	108	108	Snow Bound Area
2	2	0-1000	0	100	400	500	
3	3	0-1000	0	50	149	199	
4	4	0-1000	400	400	77	477	Road sunk
5	5	0-1000	100	157	0	157	Snow Bound Area
6	6	0-1000	0	0	0	0	
7	7	0-1000	0	100	386	486	
8	8	0-1000	0	100	453	553	
9	9	0-1000	0	0	349	349	
10	10	0-1000	0	0	278	278	
11	11	0-1000	0	100	414	514	
12	12	0-1000	0	100	425	525	
13	13	0-1000	0	0	319	319	
14	14	0-1000	0	0	282	282	
15	15	0-1000	0	0	332	332	
16	16	0-1000	0	0	0	0	
17	17	0-1000	0	0	150	150	
18	18	0-1000	0	0	125	125	
19	19	0-1000	0	0	208	208	
20	20	0-1000	0	0	0	0	
21	21	0-1000	0	0	0	0	
22	22	0-1000	0	0	0	0	
23	23	0-1000	0	50	13	63	
24	24	0-1000	0	0	167	167	
25	25	0-1000	0	0	0	0	
26	26	0-1000	0	0	266	266	
27	27	0-1000	0	0	0	0	
28	28	0-1000	0	0	540	540	
29	29	0-1000	0	0	122	122	
30	30	0-1000	0	0	16	16	
31	31	0-1000	0	0	0	0	
32	32	0-1000	0	0	171	171	
33	33	0-1000	100	100	32	132	
34	34	0-1000	0	0	287	287	
35	35	0-1000	0	0	0	0	
36	36	0-1000	0	0	164	164	
37	37	0-1000	0	0	259	259	
38	38	0-1000	0	0	75	75	

Proposed Location of WBM, BM, BC on Batote Khellani Road

39	39	0-1000	0	150	461	611	
40	40	0-1000	0	0	535	535	
41	41	0-1000	0	300	200	500	
42	42	0-1000	300	300	0	300	
43	43	0-1000	0	300	200	500	
44	44	0-1000	0	300	200	500	
45	45	0-1000	0	300	200	500	
	Total Length		900	2907	8363	11270	

Proposed Location of B/Wall

S.No.	Km	RD	Proposed Length	Proposed Height	Toe
1	1	0-1000	0	0	0
2	2	0-1000	0	0	0
3	3	0-1000	8	2.5	0.3
4	4	0-1000	8	2.5	0.3
5	5	0-1000	8	2.5	0.3
6	6	0-1000	0	0	0
7	7	0-1000	0	0	0
8	8	0-1000	0	0	0
9	9	0-1000	64	2.5	0.3
10	10	0-1000	0	0	0
11	11	0-1000	48	2.5	0.3
12	12	0-1000	48	2.5	0.3
13	13	0-1000	0	0	0
14	14	0-1000	0	0	0
15	15	0-1000	0	0	0
16	16	0-1000	8	2.5	0.3
17	17	0-1000	8	2.5	0.3
18	18	0-1000	16	2.5	0.3
19	19	0-1000	0	0	0
20	20	0-1000	0	0	0
21	21	0-1000	16	2.5	0.3
22	22	0-1000	0	0	0
23	23	0-1000	0	0	0
24	24	0-1000	40	2.5	0.3
25	25	0-1000	16	2.5	0.3
26	26	0-1000	0	0	0
27	27	0-1000	0	0	0
28	28	0-1000	0	0	0
29	29	0-1000	0	0	0
30	30	0-1000	16	2.5	0.3
31	31	0-1000	16	2.5	0.3
32	32	0-1000	16	2.5	0.3
33	33	0-1000	24	2.5	0.3
34	34	0-1000	8	2.5	0.3
35	35	0-1000	8	2.5	0.3
36	36	0-1000	24	2.5	0.3
37	37	0-1000	0	0	0
38	38	0-1000	0	0	0
39	39	0-1000	0	0	0
40	40	0-1000	0	0	0
41	41	0-1000	0	0	0
42	42	0-1000	0	0	0
43	43	0-1000	0	0	0
44	44	0-1000	0	0	0

Proposed Location of B/Wall

45	45	0-1000	0	0	0
	Total=		400		

Proposed location for Construction of Pucca Drain

S. No.	Chainage	Length	Remarks
1	15.000 to 16.000	300	
2	23.000 to 24.000	200	
3	44.000 to 45.000	200	
Total		700	

Proposed removal of Earth from the choked Hill Side Drain/ Construction of Kachha Drain and disposing it on valley side manually.

S. No.	Chainage	Length	Remarks
1	0 to 45.000	15000	as per site requirement
Total		15000	

Proposed location for Construction of Box Culvert

S.no	RD	Specification
1	Km 11.700	(1X6X6)
2	Km 33.300	(1X6X6)
3	Km 31.300	(1X2X2)

Proposed Location for Road Marking on Khellani Batote Road

S.No.	Km	RD	Proposed Length Road Marking
1	1	0-1000	108
2	2	0-1000	500
3	3	0-1000	199
4	4	0-1000	477
5	5	0-1000	157
6	6	0-1000	0
7	7	0-1000	486
8	8	0-1000	553
9	9	0-1000	349
10	10	0-1000	278
11	11	0-1000	514
12	12	0-1000	525
13	13	0-1000	319

Proposed Location for Road Marking on Khellani Batote Road

14	14	0-1000	282
15	15	0-1000	332
16	16	0-1000	0
17	17	0-1000	150
18	18	0-1000	125
19	19	0-1000	208
20	20	0-1000	0
21	21	0-1000	0
22	22	0-1000	0
23	23	0-1000	63
24	24	0-1000	167
25	25	0-1000	0
26	26	0-1000	266
27	27	0-1000	0
28	28	0-1000	540
29	29	0-1000	122
30	30	0-1000	16
31	31	0-1000	0
32	32	0-1000	171
33	33	0-1000	132
34	34	0-1000	287
35	35	0-1000	0
36	36	0-1000	164
37	37	0-1000	259
38	38	0-1000	75
39	39	0-1000	611
40	40	0-1000	535
41	41	0-1000	500
42	42	0-1000	300
43	43	0-1000	500
44	44	0-1000	500
45	45	0-1000	500
	Total Length		11270

Proposed location for Delineators and flickering cat eyes/studs			
S.No.	Chainage	Anticipated Quantity	
Batote to Khellani		Delineators	Flickering Cat eyes/road Studs
1	0.000 to 45.000	Nos.	Nos.
	Providing and fixing post delineators made of ABS round body fitted with 3 nos. 100mm dia high reflective and reflectors and mounted on M.S. pipe of 65mm dia duly powder coated with anti-rust and anti-theft steel to be installed as per direction of Engineer-in-charge.	770.00	
	Supplying of Solar Raised Pavement Markers made of polycarbonate molded body with circular shape, solar powered,LED self illumination in active mode, 360 degree illumination and reflective panels with micro prismatic lens capable of providing total internal reflection of the light entering the lens face in passive mode. The marker shall support a load of 20000 kg tested in accordance to ASTM D 4280. The marker should be resistant to dust and water ingress according to IP 65 standards and should withstand temperatures in the range of 0 C to 70 C. Color of lighting could be provided in red or yellow (amber) as per requirement and typical frequency of blinking is 1 Hz. There should be current losses of less than 20 microamperes at 2.4 V in sleepcharging mode to enhance the life of the marker and a full charge should provide for a minimum autonomy of 50 hours. The height, width and length of the marker shall not be less than 10 mm x 100 mm x 100 mm. Also, the surface diameter of the marker shall not be less than 100 mm respectively. The weight of the marker shall not exceed 0.5 Kilograms. Fixing will be by drilling holes on the road for the shanks to go inside, without nails and using epoxy resin based adhesive and complete as directed by the engineer-in-charge		2590.00
Total		770.00	2590.00

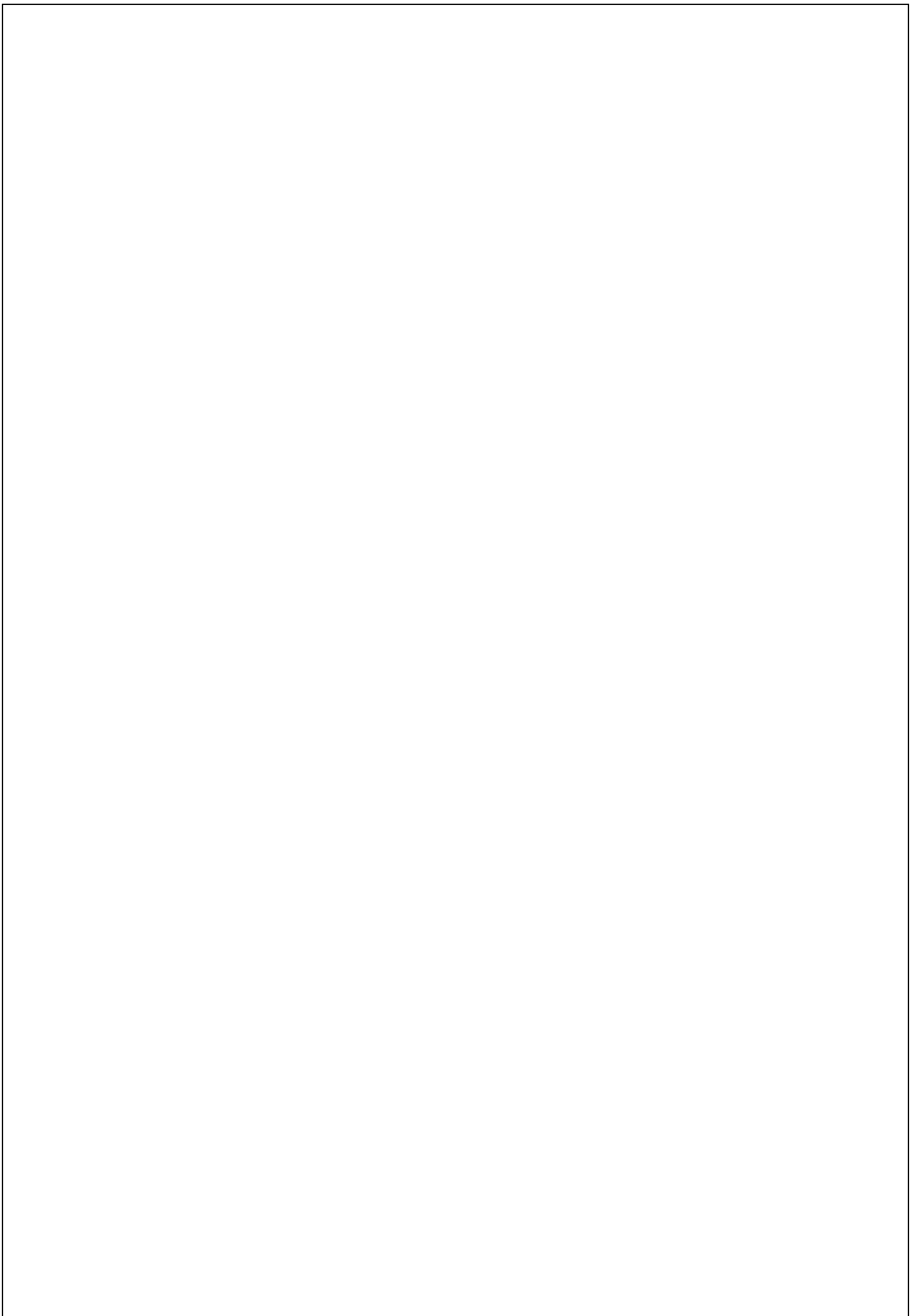



National Highways & Infrastructure Development Corporation Limited
(A Public Sector Undertaking under the Ministry of Road, Transport & Highways, Govt. of India)

PTI Building, 3rd Floor,
4, Parliament Street,
New Delhi-10001

NHIDCL/HQ/Finance/eBG/Performance Security/eFile/223137

Date: 22.02.2024

Circular No-021

Sub: Standard Operating Procedure for Acceptance, Monitoring, Renewal, Release and Invocation for Securities / Guarantees

1. **BID Security / EMD**
2. **Performance Security (PS) / Additional Performance Security (APS)**
3. **Advance Payment Security**

Ref Circular/Office order Nos.

1. NHIDCL/HR/Mis Correspondence/2020-Part (t)/187330/1155 dated 25.08.2020 (Annexure-I)
2. NHIDCL/HQ/Tender Policy/2022-Part (1)/E-215914 dated 26.07.2023 (Annexure-II)
3. MoRTH order No. NH-24028/14/2014-H(Vol-II) (E-134863) dated 31.05.2023 (Annexure-III)
4. NHIDCL/Finance/BG Matter/2023-24/E-223137 dated 05.12.2023 (Annexure-IV)
5. NHIDCL/ED-I/Gen/2022 dated 09.02.2022 (Annexure-V)

Please refer to the Circulars mentioned above.

With a view to consolidate all standing instructions related to receipt, confirmation, safe custody, encashment/release and maintenance of related records of the bid security, performance security & security for advances and to further strengthen internal control related to maintenance of financial instruments received at HQ & ROs in the form of (i) Bank Guarantee (BG) (ii) Electronic Bank Guarantee (eBG) (iii) Insurance Surety Bonds (ISB), a Standard Operating Procedure (Consolidated) is prescribed.

As per RFP and MoRTH Instructions, physical BGs are not accepted. However, in cases where the bidders/contractors are facing difficulties in getting eBG, such bidders/contractors may approach NHIDCL. The physical BGs can be accepted in such circumstances. Physical BG can be accepted in respect of validity extension of existing BGs. However, in case of replacement of the existing BG, the eBG/ISB should only be accepted.

BID Securities for EMD

Technical Division shall maintain and manage the Bid Security received/being received from the bidders in the form of Physical BG, eBG & ISB and perform all activities like acceptance, verification, SFMS confirmation, return, release, encashment and closure etc. Technical Division shall keep the bid security under their custody and also maintain its record. Detail procedure to be followed in respect of acceptance, maintenance and release of Physical BG/eBG/ISB, following procedure shall be followed:

1. Acceptance of Physical BG/eBG/ISB

- a. While accepting BG/eBG/ISB, Technical Division shall compare the contents of the BG/eBG/ISB received from the Contractor with the format prescribed in the RFP/Contract Agreement. They shall take approval of the Competent Authority after vetting by the Legal Division, in case of any deviation in the contents of BG/eBG/ISB from the format approved by the Competent Authority.
- b. While accepting BG/eBG, Technical Division shall check and confirm whether the BG/eBG are issued from the NHIDCL authorized Banks. (List of Authorized Banks enclosed). In case of ISB, it shall be checked and confirmed whether it is from the authorized Insurance Company.
- c. BG/eBG/ISB shall be subject to verification for the genuineness from the NHIDCL House Bank through SFMS platform and also parallelly from the issuing bank obtaining SFMS detail transmitted to our House Bank. SFMS confirmation must be in code 760COV (Original BG) and 767COV (extensions/amendment). In no case, confirmation in code 799 (free format) shall be entertained. In case of ISB, the verification of genuineness is to be done from the issuing Insurance Company [Manager(T) / DGM (T) / GM (T) is responsible for obtaining confirmation report from NHIDCL's House Bank]
- d. In case of non-receipt of confirmation of BG/eBG/ISB within seven working days, Technical Division shall put up the case and report to the competent authority for taking necessary action.

2. Maintenance and Release of BG/eBG/ISB

- a. Technical Division shall deal all activities of the BG/eBG/ISB for BID Security from its receipt, confirmation, safe custody, encashment and release/return at their end and related documents are to be kept with them. In case of encashment, details regarding name of the project, name of the bidder, bank name, IFSC, Amount etc. shall be shared with the Finance Division for its proper accounting.
- b. In case of release of eBG/encashment of eBG, Technical Division shall obtain an approval of the competent authority and forward the request to the Finance Division in a prescribed format to initiate through NeSL portal till the new user ids of Technical Division on NeSL portal is created.

Performance Security/ Additional Performance Security (PS/APS)

1. Acceptance of Physical BG/eBG/ISB

- a. While accepting BG/eBG/ISB, Technical Division shall compare the contents of the BG/eBG/ISB received from the Contractor with the format prescribed in the RFP/Contract Agreement. They shall take approval of the Competent Authority after vetting by the Legal Division, in case of any deviation in the contents of BG/eBG/ISB from the format approved by the Competent Authority.
- b. While accepting BG/eBG, Technical Division shall check and confirm whether the BG/eBG issued from the NHIDCL authorized Banks. In case of ISB, it shall be checked and confirmed whether it is from the authorized Insurance Company.
- c. While receiving BG/eBG/ISB, Technical Division should check and ensure that the BG's/eBG's operable Branch is at Delhi or NC Region (for HQ) and the claim period is one year more than the validity of the BG/eBG/ISB.
- d. After receiving the BG/eBG/ISB, Technical Division shall provide details of Securities/Bonds (e.g. Name of Bank/Insurance Company, BG/eBG/ISB No., Amount (Rs.), Issuing Date, Validity Period, Claim Period, Name of the Applicant) to the Finance Division within three working days through email (conf.fin.hq@gmail.com) for seeking confirmation from NHIDCL's House Bank (Canara Bank, Transport Bhawan Branch, New Delhi, IFSC-CNRB0019062).
- e. Finance Division shall seek for & obtain confirmation report from the House Bank / Insurance Company within seven working days through email keeping the concerned Technical Division in the mail loop so that they are instantly informed & updated about the confirmation report [Asstt. Manager (Fin) / Manager (Fin) is the responsible for obtaining confirmation report from NHIDCL's House Bank]
- f. In case of non-receipt of BG/eBG/ISB confirmation within seven working days from the House Bank (House Bank confirms as NOT RECEIVED), Technical Division shall put up the case and report to the competent authority for taking further necessary action.

2. Registering on BGMS Portal

- a. Technical Division will upload the PDF (scan copy of *guarantee/insurance bond*) on the BGMS Portal only on receipt of SFMS confirmation within 3 working days [uploading to be done by [Manager(T) / DGM (T) / GM (T)] and submit the physical BG to the Finance Division along-with the SFMS confirmation report. SFMS confirmation must be in code 760COV (Original BG) and 767COV (extensions/amendment). In no case, confirmation in code 799 (free format) shall be entertained. In case of eBG/eISB, the physical documents of eBG/eISB are not to be shared with the Finance Division but only its confirmation report is to be shared with the Finance Division after uploading the same on the BGMS portal.

Technical Division shall also obtain an acknowledgement from Finance Division.

- b. Technical Division while uploading the PDF (scan copy of guarantee/insurance bond) on BGMS portal, the BG/ISB numbering pattern should followed in the following pattern:

- | | |
|----------------|---------------------------|
| a. Physical BG | - xxxxxxxxxxxxxx |
| b. eBG | - Electronic/xxxxxxxxxxxx |
| c. ISB | - ISB/xxxxxxxxxxxx |

3. Renewal of BG/eBG/ISB

- a. Technical Division should regularly monitor validity of the **BG/eBG/ISB** and a reminder notice should be issued to the Contractor/Agency well in advance to ensure that the validity of securities/bonds are extended two months prior to expiry of BG/eBG/ISB and validity extension should be for a period of at least one year.
- b. No payment be released to the contractors whose validity of the BG is less than the prescribed period of 2 months. It should also be ensured that no payment is released to the contractor/agency unless extended BG is authenticated with SFMS confirmation report by our House Bank. It may be appreciated that compliance of the contractual terms and conditions is the responsibility of the Authority Engineer and field office. Encashment of BG due to non-renewal is a last resort and should arise only in rare cases.

4. Claim Lodge for Invocation due to Non-Renewal

- a. Every month, the Finance Division shall review BGs expiring in the next month. Finance Division shall obtain approval of competent authority for lodging claims for invocation of BG/eBG/ISB's whose validity is expiring in next month (e.g. approval of competent authority is obtained by first week of December 2023 for BGs expiring in January 2024).
- b. The issuing bank/insurance company will be allowed to extend the BG/eBG/ISB. In such cases, the encashment claim can be withdrawn.
- c. While lodging a claim, Finance Division shall convey the approval of the competent authority to all concerned along-with a list of pending renewal cases (BG/eBG/ISB) to review and confirm the latest status of validity extension.
- d. In case of eBG, the Finance Division shall lodge a claim to the Bank/Insurance Company through NeSL Portal to EXTEND or PAY and inform through email to the Technical Division about the action taken.
- e. Finance Division shall update BGMS portal with change of Status as 'CLAIM LODGED DUE TO NON-RENEWAL' and upload a copy of the claim lodged.
- f. In case validity period is extended, Technical Division shall upload the status of the BG/eBG/ISB on the on BGMS portal and also intimate and submit the extended BG/eBG/ISB with SFMS confirmation report to the Finance Division.
- g. In case of non-receipt of the validity extension or delay in confirmation, the concerned Technical Division shall report to the competent authority for taking further necessary action for withdrawal of LOA/Termination of the Contract/ encashment of existing BG.

5. Encashment of BG/eBG/ISB due to Contractor's Default/Foreclosure/Termination

- a. Technical Division shall obtain approval of the competent authority for encashment of BG/eBG/ISB on the ground of default, non-performance, termination, foreclosure etc. and convey the same to the Finance Division.
- b. Finance Division shall lodge a claim for encashment of BG/eBG/ISB with the operable Bank branch in Delhi/NCR in case of HQ cases and submit the original BG documents along-with claim letter. Acknowledgment shall be obtained from the concerned Bank Branch for lodging of the claim and receipt of original BG/eBG/ISD. Once original BG/ISD have been submitted to the Bank/ Insurance Company, the Finance Division shall intimate to the concerned Technical Division. In the case of invocation of eBG, claim shall be lodged with the Bank through NeSL Portal and information about the action taken shall be intimated to Technical Division through email.
- c. Finance Division shall update the status of BG/eBG/ISD on the BGMS portal as 'SENT FOR ENCASHMENT'.
- d. On receipt of proceeds of BG encashment, Finance Division shall close the BG/eBG/ISD account on the BGMS portal and inform to the Technical Division updating BGMS as "BG ENCASHED" and pass a necessary entry in the books of accounts.

6. Release of BG/eBG/ISB

- a. The approval of the competent authority shall be obtained by the Technical Division for the release of Performance Security and Additional Performance Security and forwarded to Finance Division.
- b. On receipt of the request/authority letter from Technical Division regarding release of BG/eBG/ISB, Finance Division shall return the BG/ISB to the Technical Division and update the BGMS portal by attaching the copy of BG/ISD acknowledgement letter/document. In case of eBG, Finance Division shall raise a request for release/return/ closure through NeSL portal and inform Technical Division about the action taken.
- c. Finance Division shall update status of BG/eBG/ISD on the BGMS portal as 'CLOSED'.

Process to be followed in the Regional Offices (RO)

ROs shall follow the above-mentioned process in respect of BG/eBG/ISB for M&R Projects and Security for advances. In case of eBG, they should take the access of eBG management & monitoring for their cases for advance payment, PBG for M&R Project, Retention etc. and obtain registration on NeSL Portal with the approval of competent authority for all the necessary activities like accepting, viewing, monitoring, extending validity, invocation, encashment, release etc. on their own.

- a. All securities/guarantees for advances are to be payable at the respective ROs.
- b. In cases where BGs related to advances are payable at New Delhi and have been kept at HQ Office, the ROs shall get it amended as payable at the RO.

- Then, the RO shall collect advance BGs available at HQ and keep them in their custody and do necessary amendment in operable branch of the BG.
- c. Encashment proceeds of BGs related to advances, if encashed at HQ should be credited to RO by adjusting outstanding advance and interest thereon. Proceeds of encashment of performance BG to be utilized for project payment of the Scheme to which the contract whose BG was encashed. Details of the BG encashed should be maintained for making necessary adjustment at the time of process of Final Bill.
 - d. It is again emphasized that while releasing any payment to the contractors/agencies, it should be ensured that the securities/bonds validity and confirmation is active/live in case of advance payment/performance security including available at HQ.

Handling special cases including fake BG

In case of denial of the issuance of BG by the issuing bank, the BG may be treated as fake BG. In case of non-confirmation, the case becomes a suspected case of fake BG. Therefore, special care needs to be taken in such cases as given below.

- a. The matter may be reported immediately to the Director and Managing Director.
- b. A show cause notice may be issued to the contractor for black listing of the bidder and a police complaint, in consultation with the Legal Division be lodged by Legal/HR Division.

Annual Physical Verification of BG

Each year, physical verification of all BG/eBG/ISB is to be carried out through a committee constituted in this regard with the approval of the competent authority.

This is issued with the approval of Competent Authority.

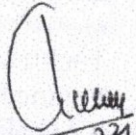
 (Anil Kumar Gautam)
 General Manager (Finance)

Encl: As Above:-

Copy to:

1. All EDs (T), NHIDCL
2. All EDs (P), NHIDCL
3. All GMs (T) / DGMs (T), NHIDCL
4. GM (IT), NHIDCL
5. PS to Managing Director
6. PS to Director (A&F)
7. PS to Director (T1 & T2)

National Highways & Infrastructure Development Corporation Limited
3rd Floor, PTI Building, New Delhi-110001

Ref No.: NHIDCL/F&A-25/2019-20/E-182855/5 16

Dated: 22nd March 2023

Order No. 2023/NHIDCL/HR/1493 Office Order

Subject: Mandatory E-BG, EMD and Tender fee Deposit through Induscollect

E-Bank Guarantee

An Electronic Bank Guarantee (e-BG) eliminates the physical documentation usually associated with issuance of BG. It reduces the turn-around time of the BG. The digital steps in an e-BG includes BG application, preview and confirm, paperless e-stamping, e-signing, hosting of the final electronic BG on the NeSL portal and intimation of final BG to the beneficiary (e.g NHIDCL). The beneficiary can view the final digital BG on the NeSL portal immediately on issuance. Such an e-BG eliminates the need for a separate authentication from the BG issuing Bank. At present seven banks are issuing E-BG (State bank of India, Canara Bank, Indian Overseas Bank, HDFC Bank, ICICI Bank, Axis Bank and Yes Bank and more may start soon. The Ministry of Road Transport and Highways has prescribed acceptance of E-BGs vide their OM No. NH-35014/20/2020-H dated 12th August 2022.

2. The bidders/contractors/DPR Consultants and Authority Engineers submit BG as bid security, PBG, APBG and BG against advances. It takes time in getting SFMS confirmations and in many cases, the SFMS confirmations are not received.

3. In view of above, the Competent Authority has decided that from first April 2023 only E-BG shall be accepted. No BG shall be accepted in the physical form. The format of the BG will remain the same as prescribed in the RFP documents.

4. Entity ID of NHIDCL is AAECN7759E, which may be quoted for getting e-BG.

5. For any further details, the bidders/contractors may visit the website of National E Governance Services Limited at <https://nesl.co.in/e-bg/>

6. For E-BGs, the IFSC code and name of the bank should be continued to be Canara Bank, Transport Bhawan, Sansad Marg, New Delhi-11001 as given below:

Sr. No.	Particulars	Details
(i)	Name of Beneficiary	MD-NHIDCL
(ii)	Beneficiary Bank Account No	90621010002659
(iii)	Beneficiary Bank Branch	Canara Bank, Transport Bhawan, 1-Parliament Street, New Delhi-110001
(iv)	Beneficiary Bank Branch IFSC	CNRB0019062



Bid Security and Tender fee

7. The bidders will continue to have facility to deposit the bid Security/tender fee into the bank account of the NHIDCL through the online facility provided by the Indusind Bank. **No amount may be deposited directly in the bank account of NHIDCL.** The payment through bank portal will facilitate issuance of invoice for the tender fee and refund of EMD to the unsuccessful bidders immediately on finalization of the bidder.

8. Please refer below steps to do the transaction for payment of EMD and tender fee via Payment Gateway/ generate NEFT/ RTGS challan by visiting website as given below:

Visit IndusCollect website: <https://induscollect.indusind.com/pay/index.php>

Step by Step process is attached as Annexure- I

9. Requisite changes may please be made in the RFP by the Technical Division.

This bears the approval of the Competent Authority.



(Mahesh Gupta)

Dy. General Manager (Fin)

Copy to :

1. All ED (T). *All GM(T), All DyGM(T)*
2. PS to MD, NHIDCL for information please.
3. PS to Dir (A&F), for information please.
4. PS to Dir (T), for information please
5. GM(IT) for uploading on the employees portal

Encl: As above

Steps for Bidder Payment

1. Visit IndusCollect website: <https://induscollect.indusind.com/pay/index.php>

2. Kindly select one of the two tabs:

Express Payment (For Non-Registered User)

Login (For Registered User)

3. If you are a registered user of IndusCollect, then login click on LOGIN tab. If you are not registered user of IndusCollect then click on Express Payment tab.

IndusInd Bank

Home | About us | FAQs

INDUS COLLECT

Search, Pay & Confirm

Pay bills and invoices from any bank account or any card

IndusCollect lets you pay your bills conveniently, be it your education, housing society maintenance or any other bills. You can pay your bills using RTGS, NEFT, IMPS, IFT, UPI, Net Banking or Cards.

Search Pay Confirm

Express Payment Login

Registered user click LOGIN

Search by Merchant Name eg. universiti-high

Non Registered user click here

Select a Category

- Charitable Institutions and Trusts
- Clubs and Associations
- Distributors and Vendors
- Education
- E-tailers and E-commerce
- Entending
- Government Bodies
- Housing Development & Societies

Flow for Non-Registered Users

a. Select Category

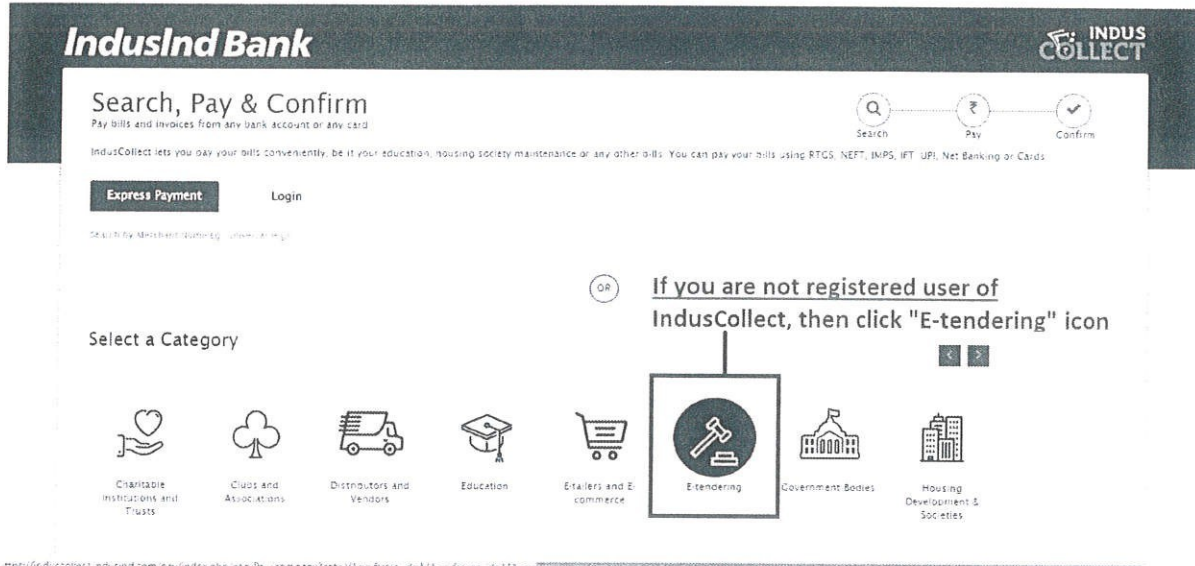

b. Type NHIDCL:

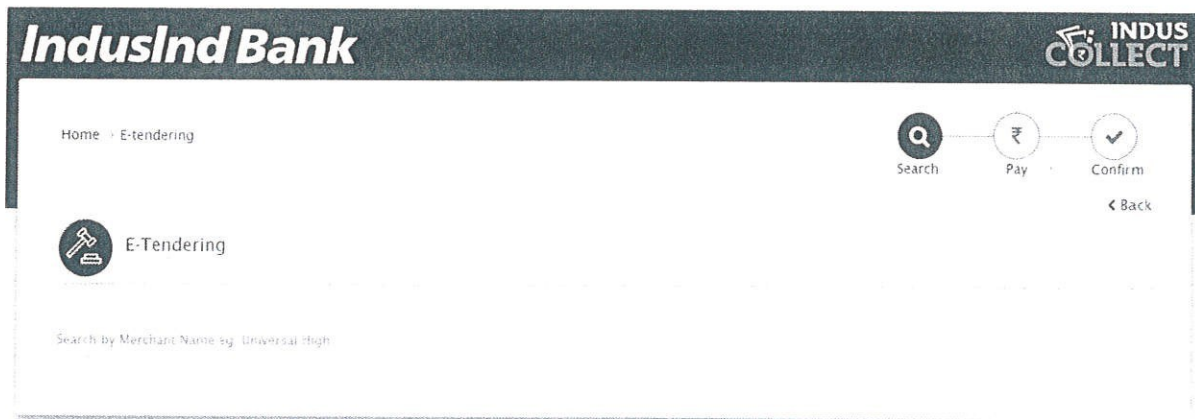

c. Select type of payment:

The screenshot shows the IndusInd Bank website interface. At the top, there is a dark navigation bar with the text "Home | About us | FAQs" on the right and the "IndusInd Bank" logo on the left. Below the navigation bar, the "INDUS COLLECT" logo is visible. The main content area features a breadcrumb trail "Home > E-tendering >". To the right, there are three circular icons: "Search" (magnifying glass), "Pay" (₹ symbol), and "Confirm" (checkmark), with a "< Back" link below them. On the left side, there is a logo for "MIDCL" (Maharashtra Industrial Development Corporation). The central part of the page contains a form with a dropdown menu labeled "Please select" and a "Tender Fees" button. The dropdown menu is open, showing "Please select" and "Tender Fees" as options.

d. Enter Data & Click Submit:





Search



Pay



Confirm

[< Back](#)



I want to make payment for

Department*

Division*

Job ID*

Tender type*

Contractor Name*

Mobile No*

Email*

Amount*

Verify Code*

Tender Fees ▼

.....

Please Select Tender type ▼

.....

FILL YOUR FIRM/COMPANY NAME

.....



[Generate New Code \(/pay/index.php/easyPay/captcha?refresh=1\)](http://pay/index.php/easyPay/captcha?refresh=1)



Submit

Cancel

e. Select the payment mode:

IndusInd Bank

Home | Enterprise | NIGRA AUTHORITY | Payment



Reference No. 111111872800540
Click To Fetch Reference

Invoice No.
FY 17-18

Account No.
BC I





Job ID

Please add value
Amount: INR
7045570455

Email
dandey@gmail.com

Bank Amount
100.00

 **Payment Options**

 Internet Banking	0
 Credit Card	0
 Debit Card	0
 NEFT, RTGS, IMPS, Transfer within Bank	0

- f. If user clicks “Internet Banking” or “Credit Card” or “Debit Card”, then user will be redirected to Payment Gateway page.
- g. If user selects NEFT or RTGS or IMPS or Transfer within Bank, then:

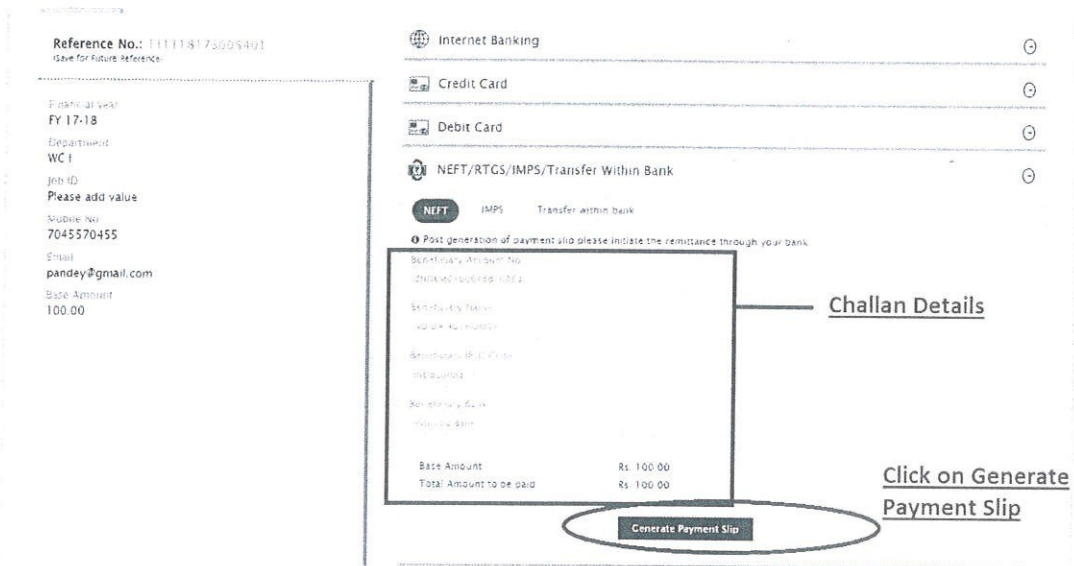

- i. User has to click on Generate Payment Slip to generate challan. It will have beneficiary account number and IFSC code.
- ii. User will then login to their own bank’s Netbanking or mobile app.
- iii. User will add beneficiary basis the details on Challan.
- iv. User will then make the payment to beneficiary

Flow for Registered Users

a. Click Login

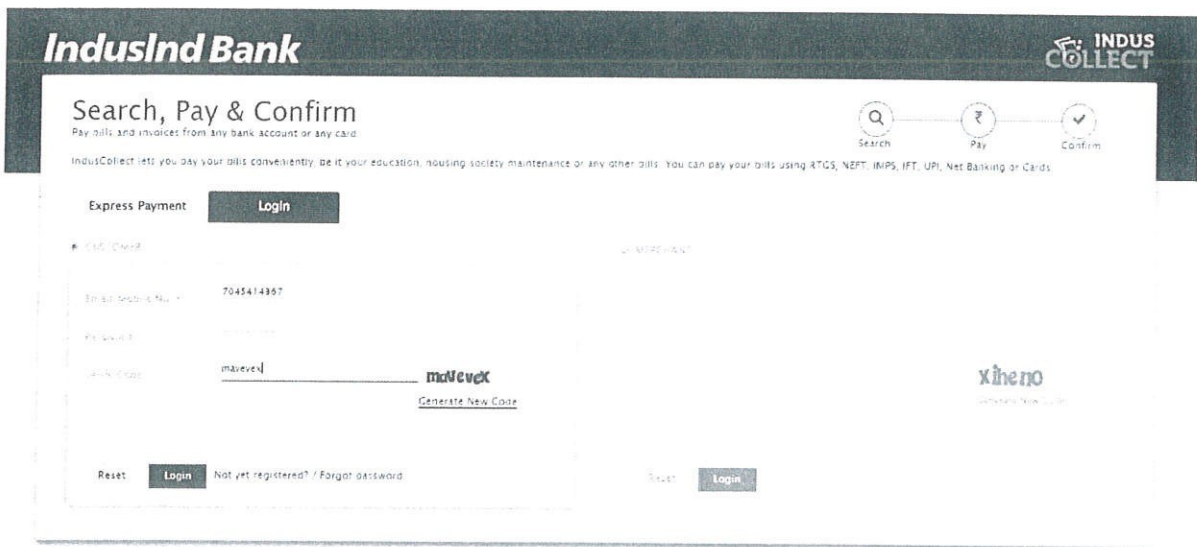

IndusInd Bank INDUS COLLECT

Search, Pay & Confirm

Pay bills and invoices from any bank account or any card

INDUSCollect lets you pay your bills conveniently, be it your education, housing, society maintenance or any other bills. You can pay your bills using RTGS, NEFT, IMPS, IFT, UPI, Net Banking or Cards.

Express Payment

Enter Bill No.

Enter Biller No.

Biller Name

xthemo

[Not yet registered? / Forgot password](#)

b. Click on MAKE PAYMENT

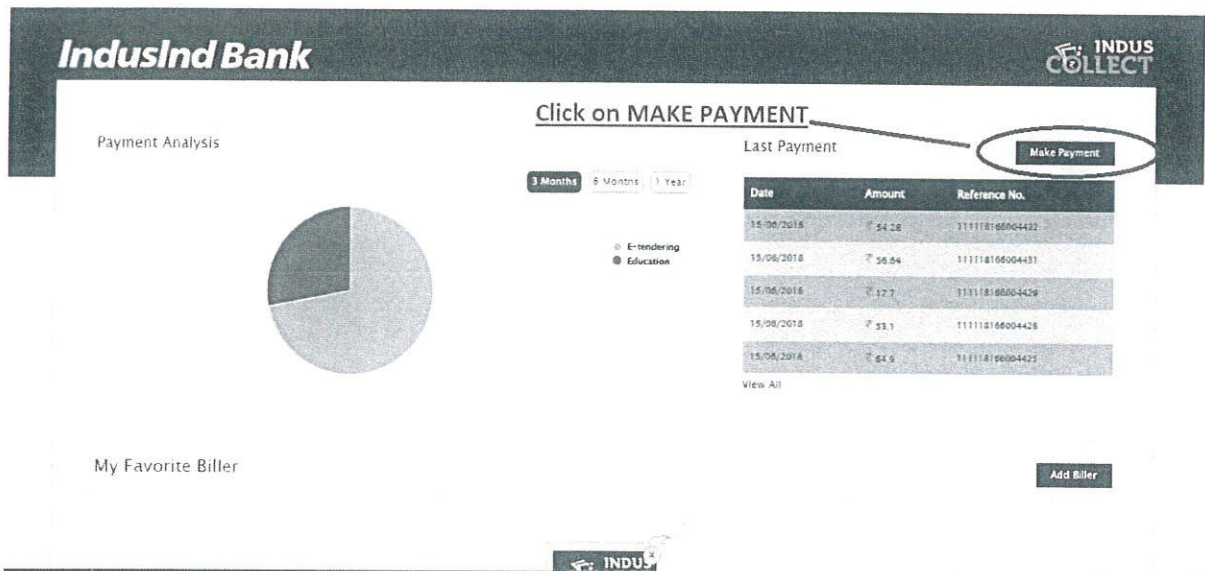

IndusInd Bank INDUS COLLECT

Payment Analysis

E-tendering
 Education

My Favorite Biller

Click on MAKE PAYMENT

Last Payment

Date	Amount	Reference No.
15/06/2018	₹ 54.28	111118166004422
15/06/2018	₹ 56.54	111118166004431
15/06/2018	₹ 17.7	111118166004428
15/06/2018	₹ 53.1	111118166004428
15/06/2018	₹ 64.5	111118166004425

[View All](#)

c. Select Category

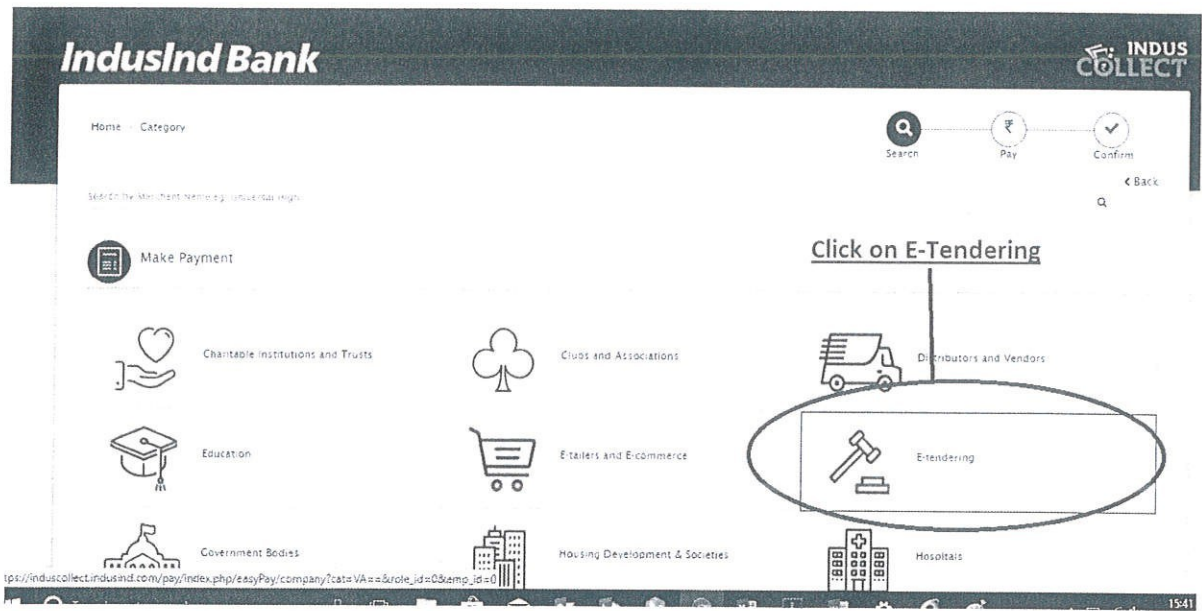

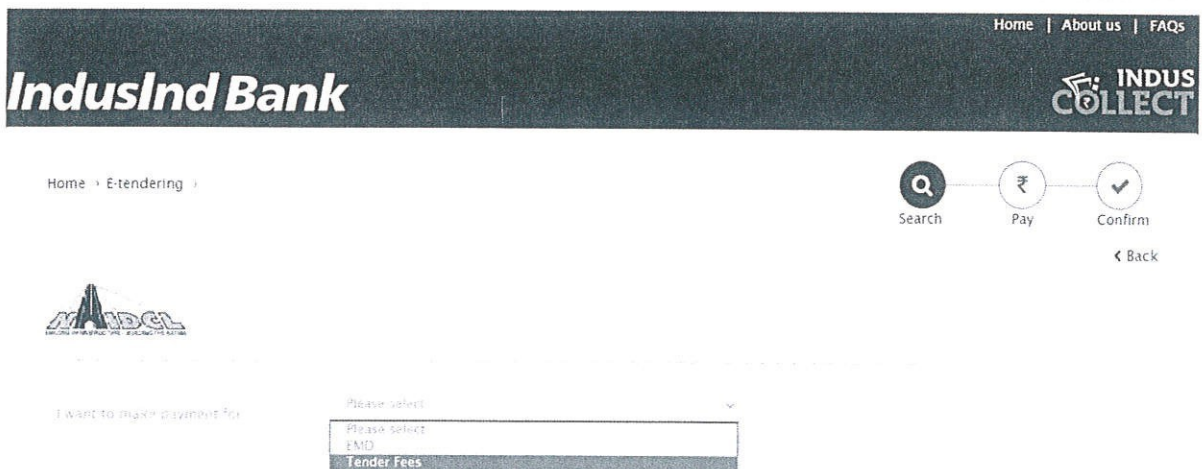
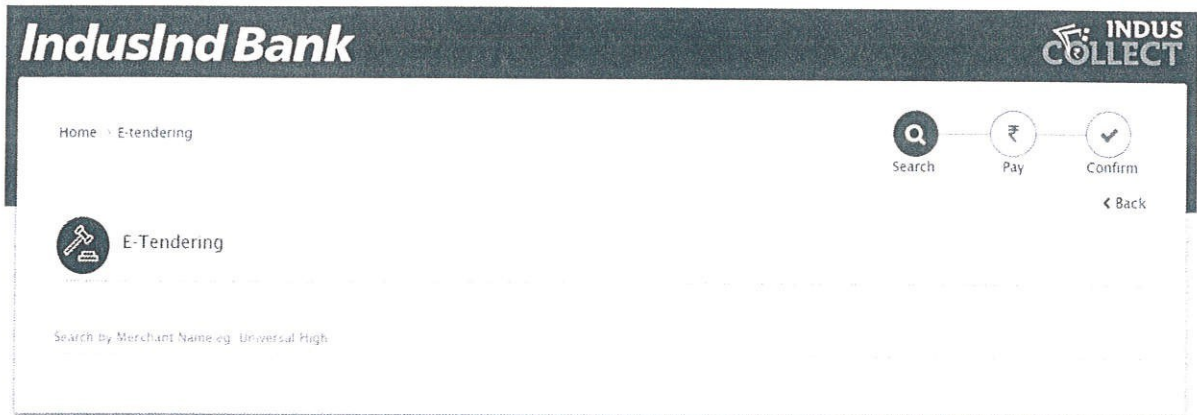

d. Type NHIDCL and Select type of Payment:



e. Enter Data & Click Submit:



[← Back](#)



I want to make payment for **Tender Fees**

Department*

Division*

Job ID*

Tender type* **Please Select Tender type**

Contractor Name* **FILL YOUR FIRM/COMPANY NAME**

Mobile No*

Email*

Amount*

Verify Code*

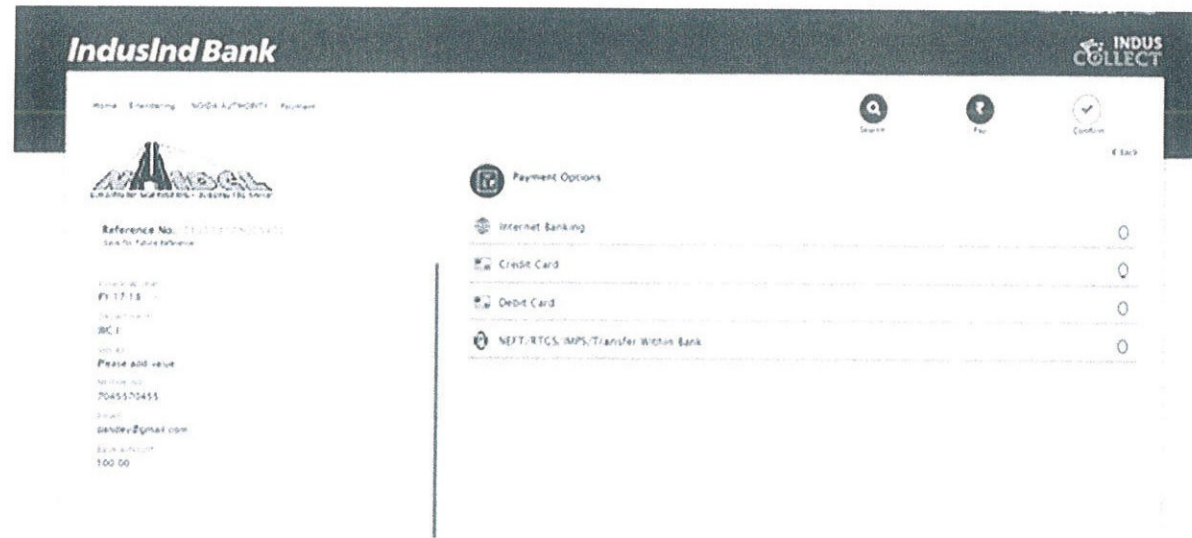

[Generate New Code \(/pay/index.php/easyPay/captcha?refresh=1\)](http://pay/index.php/easyPay/captcha?refresh=1)

f. Select the payment mode:

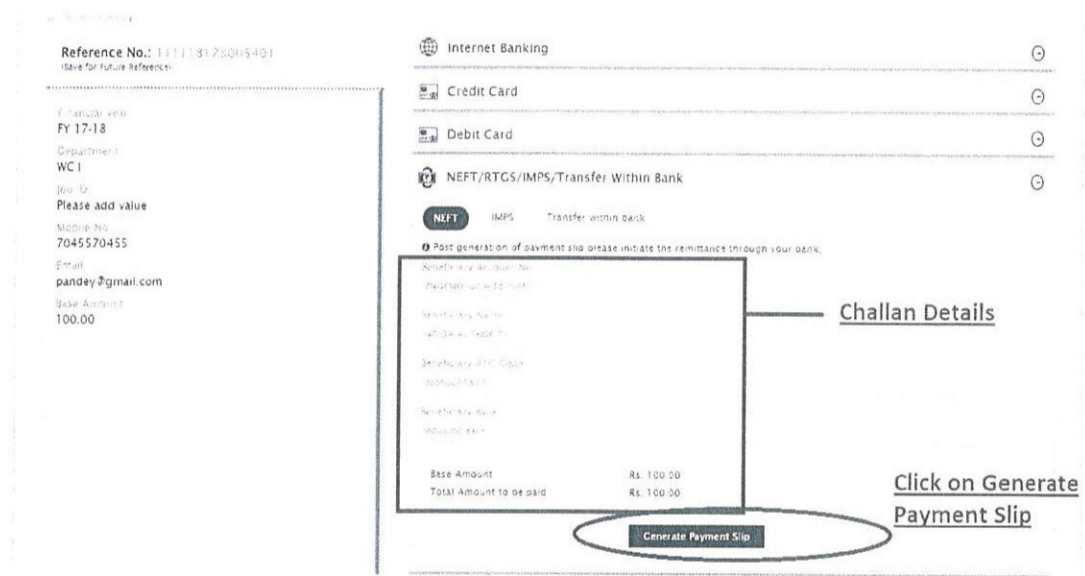

g. If user clicks “Internet Banking” or “Credit Card” or “Debit Card”, then user will be redirected to Payment Gateway page.

h. If user selects NEFT or RTGS or IMPS or Transfer within Bank, then:



- i. User has to click on Generate Payment Slip to generate challan. It will have beneficiary account number and IFSC code.
- ii. User will then login to their own bank’s Netbanking or mobile app.
- iii. User will add beneficiary basis the details on Challan.
- iv. User will then make the payment to beneficiary

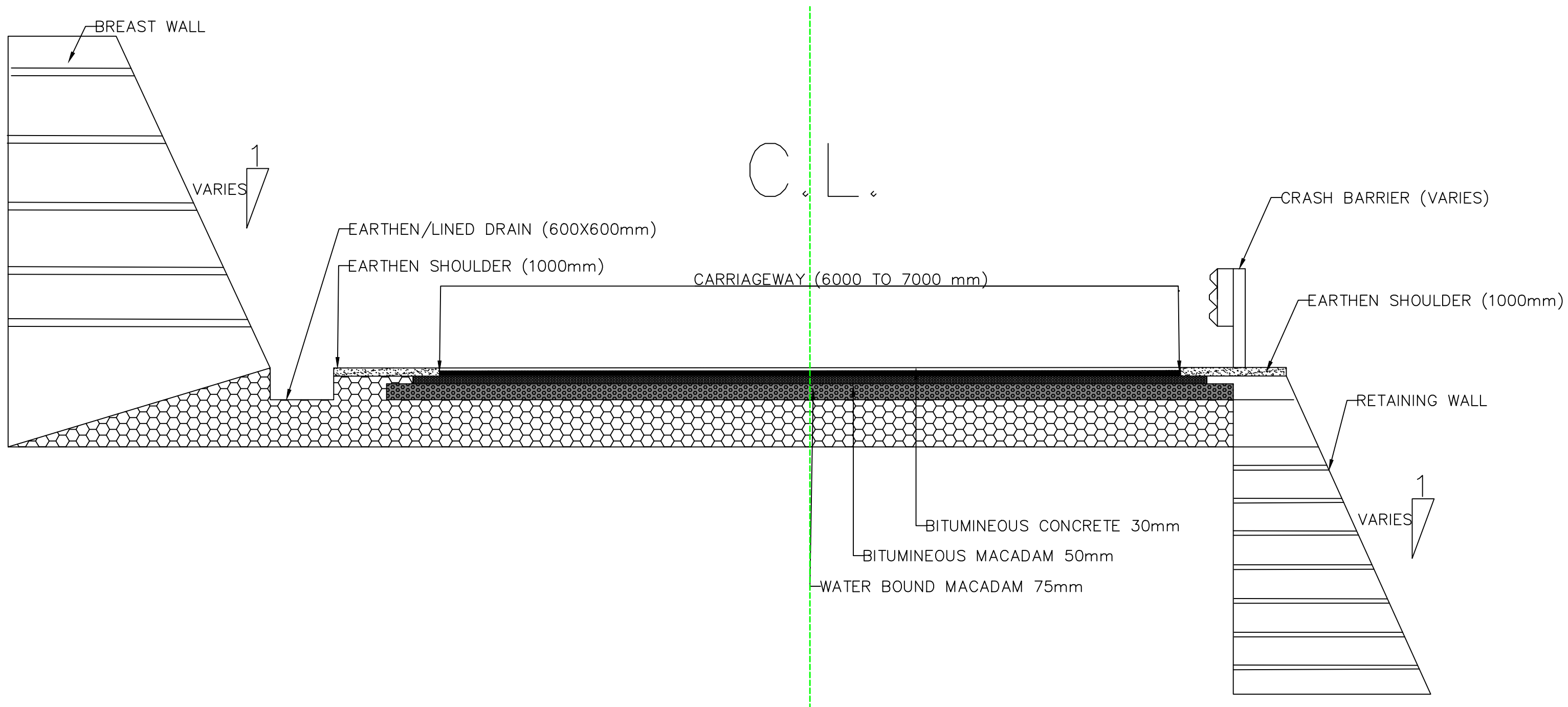

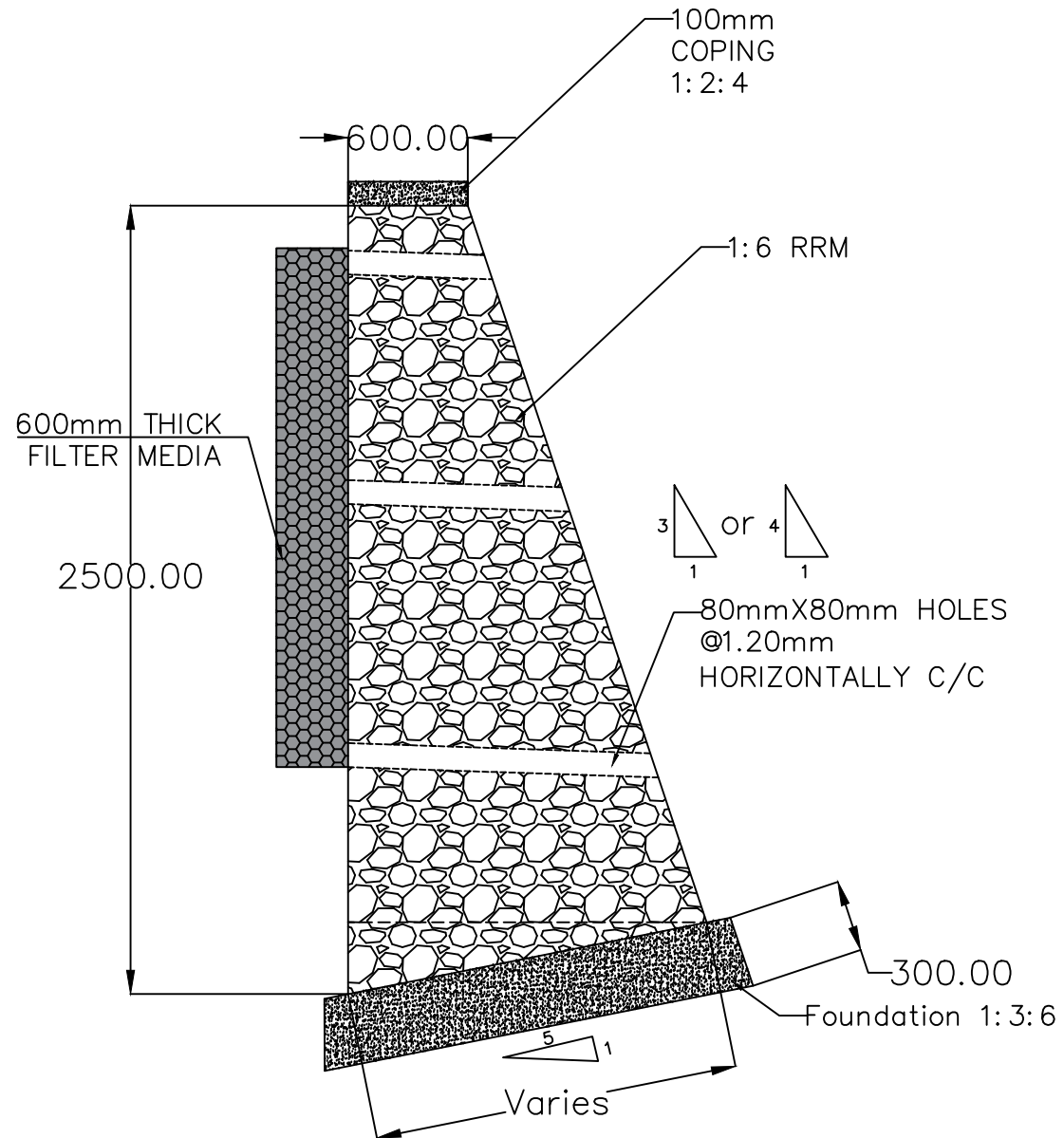

All the Dimensions are in MM unless specified.

RANDOM RUBBLE MASONRY BREAST WALL

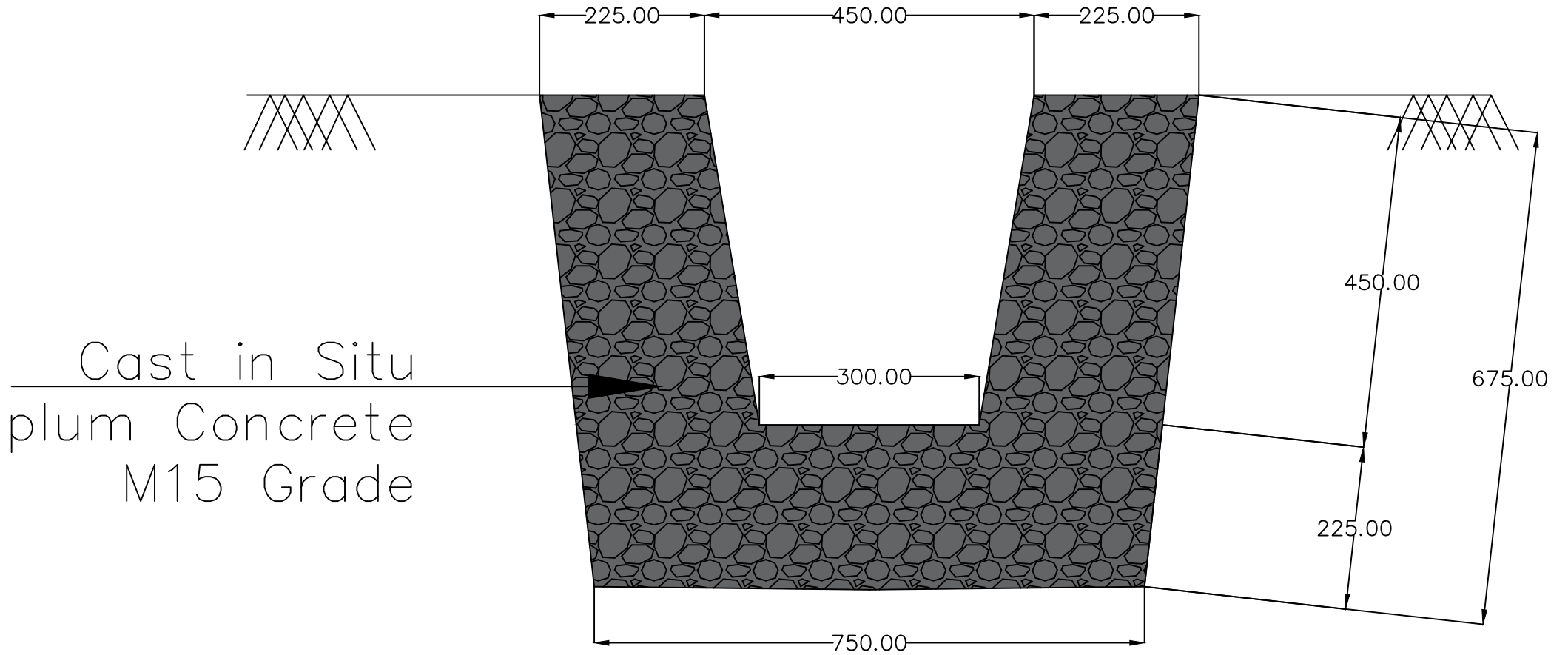

X-Section for
Construction of lined
Drain